



2026
versiyon
version 0100/1125

ÜRÜN BROŞÜRÜ PRODUCT BROCHURE

DEĞİŞTİRİLEBİLİR UÇLU TAKIMLAR, TAKIM TUTUCU SİSTEMLER VE KESİCİ UÇLAR
INDEXABLE TOOLS, TOOL HOLDER SYSTEMS AND CUTTING INSERTS

*konusulan
the spoken kalite...
quality...*



www.akkо.com.tr

[f](#) [@](#) [v](#) [in](#) AKKO Metalworking Tools





1986 yılında Abdullah KARAKUŞ tarafından kurulan AKKO Makina Sanayi ve Ticaret A.Ş. Tornalama Takımları, Diş ve Kanal Açma Takımları, Delik Delme Takımları, Frezeleme Takımları ve talebe yönelik Özel Takımlar, Monoblok ve Tutucular ile Profil Uçlar üretmektedir. Şu an 40.000m²'ye yakın bir alanda Türkiye, Japonya, Almanya, İsviçre gibi ülkelerin ürettikleri son teknoloji tezgah ve ekipmanlarıyla yıllık 750.000 adet üretim kapasitesiyle, standart 14.000 çeşit takım üretimi ve 400.000 adet profil uç üretimi yapmaktadır. Avrupa, Asya, Afrika, Güney Amerika, Kuzey Amerika ve Orta Doğu kıtalarında şimdilik düzenli olarak 90 ülkeye ürün sevkiyatına devam etmektedir. Minimum 300.000 adet üretilmiş ürün stoklarında mevcut bulunmaktadır. Firma için özel üretilen çelik hammadde işleme girer ve bütün üretim süreci kendi bünyesinde gerçekleşmektedir. Çeliğin işlenmesi, ısıl işleme, üzerindeki kaplama ve her türlü üretim operasyonları bir entegre tesis olan AKKO'da yapılmaktadır.



We as AKKO Makina Sanayi ve Ticaret A.Ş. which were founded by Abdullah KARAKUŞ in 1986, produce Turning Tool Holders, Threading and Grooving Tool Holders, U-Drills, Milling Tool Holders, Precision Tool Holders (OEM Tool Holders) on-demand, Monoblocks and Holders, and Profile Inserts. We produce a standard 14.000 kinds of tool holders with a production capacity of 750.000 pieces and 400.000 pieces of special profile inserts per year in an area of about 40.000 square meters. We are going on regularly exporting to 90 countries including European, Asian, African, South American Countries, North American Countries, and Middle Eastern countries. We keep ready about 300.000 pieces produced products in our stock. Steel Raw materials that we make produced especially for us are delivered our factory and all production process are made in our factory. All kinds of operations from machining of steel to heat treatment and coating on our tools are made in our integrated factory AKKO.



TS EN ISO 9001:2015

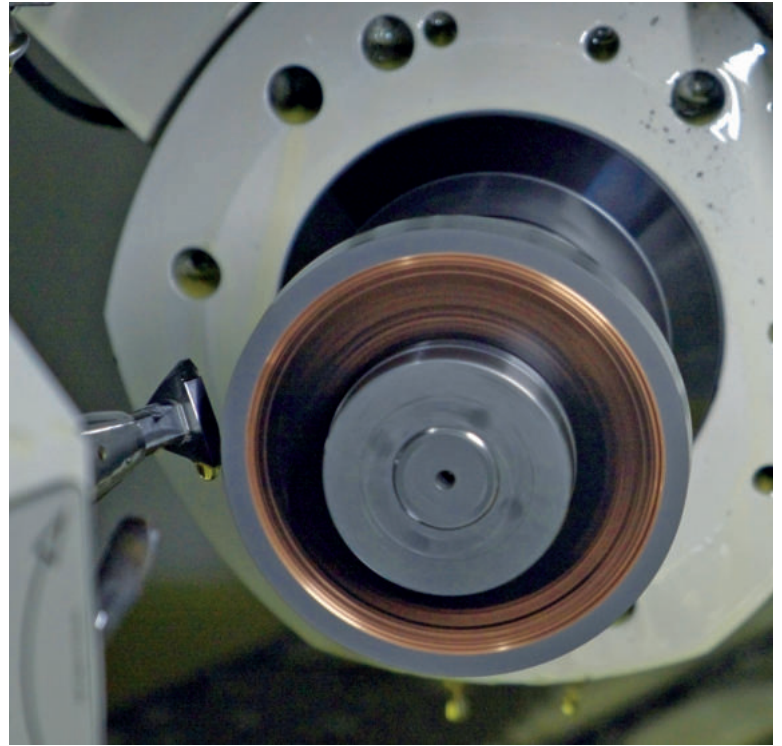
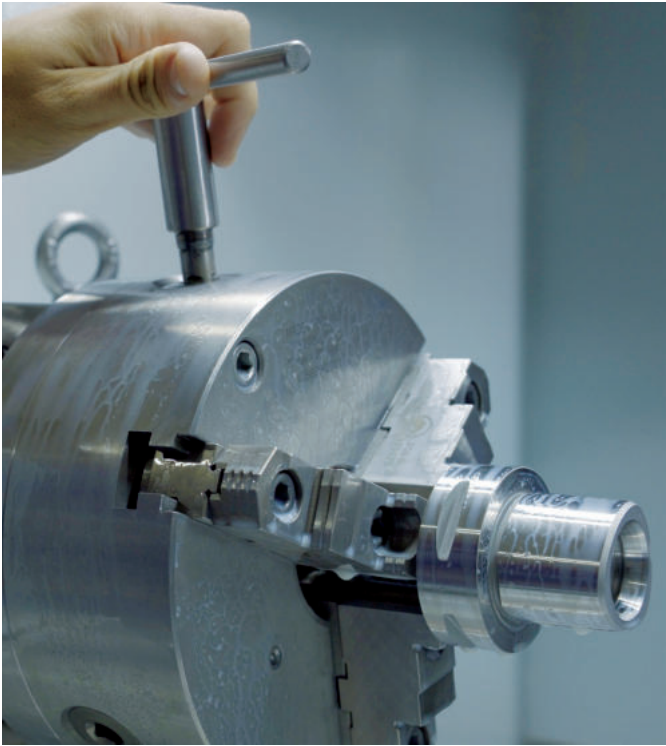

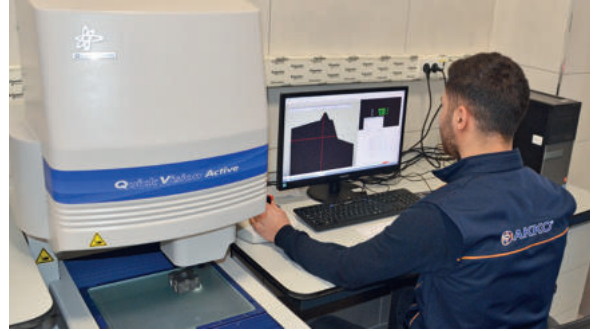
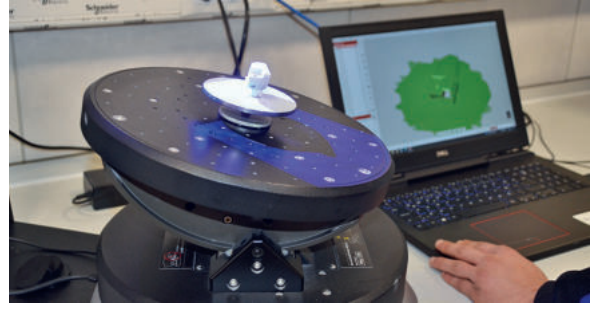

KALİTE KONTROLÜMÜZ ALTINDA





Yüksek teknolojiye sahip makinelerimizde üretilen ürünlerimiz ile önceliğimiz müşteri memnuniyetini sağlamaktır. Bu kapsamda mevcut laboratuvarımızda bulunan hassas ölçüm ve malzeme test cihazları ile uzman kadromuz tüm kalite kontrol proseslerini gerçekleştirmektedir. Hammadde giriş kontrolünden itibaren imalat proses sürecinde ara kontroller, imalat sonrası son kontroller ve sürekli iyileştirme çalışmaları yapılarak yüksek kalitede ürünler üretilmektedir. Firmamızın temel amacı en kaliteli ürünü, en ekonomik şekilde ve tam zamanında üretmektir.

OUR QUALITY IS UNDER CONTROL

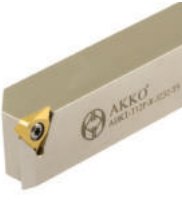

Our priority is to provide customer satisfaction with our products produced in our high-tech machines. In this context, our expert staffs carries out all quality control processes with precision measurement and material testing devices in our current laboratory. High quality products are produced from the raw material with entry control through the use of intermediate controls, post-production final checks and continuous improvement studies in the manufacturing process. The main purpose of our company is to produce the highest quality products in the most economical way and on time.

Kesici Uçlar ve Takımları / Cutting Inserts and Toolholders

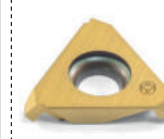

POLY-V Kanal Açma Uçları ve Takımları / POLY-V Grooving Inserts and Toolholders

 <p>AKKO (T12P) UCUNA UYGUNDUR COMPATIBLE WITH AKKO (T12P) INSERT</p>	<p>NEW ADKT-T09P-R/L-1212-T3</p> <p>NEW ADKT-T09P-R/L-1616-T3</p> <p>NEW ADKT-T09P-R/L-2020-T3</p> <p>NEW ADKT-T09P-R/L-2525-T3</p> <p>ADKT-T12P-R/L-1616-T5</p> <p>ADKT-T12P-R/L-2020-T5</p> <p>ADKT-T12P-R/L-2525-T5</p> <p>ADKT-T12P-R/L-3232-T5</p>	 <p>T12.10.0234.PJ.R T12.10.0356.PK.R T12.10.0470.PL.R</p>	 <p>AKKO (T30P) UCUNA UYGUNDUR COMPATIBLE WITH AKKO (T30P) INSERT</p>	<p>ADKT-T30P-R-1616-3.56</p> <p>ADKT-T30P-R-1616-2.34</p> <p>ADKT-T30P-R-2020-3.56</p> <p>ADKT-T30P-R-2020-2.34</p> <p>ADKT-T30P-R-2525-3.56</p> <p>ADKT-T30P-R-2525-2.34</p> <p>ADKT-T30P-R-3232-3.56</p> <p>ADKT-T30P-R-3232-2.34</p>
	<p>NEW ADKT-T20P-R/L-1212-T5</p> <p>NEW ADKT-T20P-R/L-1616-T5</p> <p>NEW ADKT-T20P-R/L-2020-T5</p> <p>NEW ADKT-T20P-R/L-2525-T5</p>	 <p>T12.07.0234.PJx2 T30.07.0356.PK.x2</p>	 <p>AKKO (T12P) UCUNA UYGUNDUR COMPATIBLE WITH AKKO (T12P) INSERT</p>	<p>ATPVK 2020 K2.34X4</p> <p>ATPVK 2525 M2.34X4</p> <p>ATPVK 3232 P2.34X4</p> <p>ATPVK 2020 K3.56X4</p> <p>ATPVK 2525 M3.56X4</p> <p>ATPVK 3232 P3.56X4</p> <p>ATPVK 2020 K4.7X3</p> <p>ATPVK 2525 M4.7X3</p> <p>ATPVK 3232 P4.7X3</p>

Kanal Açma, Köşe Boşaltma Uçları ve Takımları / Inserts and Toolholders For Grooving Corner Reliefs

 <p>AKKO (T20) UCUNA UYGUNDUR COMPATIBLE WITH AKKO (T20) INSERT</p>	<p>AAUT-T20-R/L-1616-45</p> <p>AAUT-T20-R/L-2020-45</p> <p>AAUT-T20-R/L-2525-45</p>	 <p>T20.00.0815.45.04R/L T20.00.1220.45.05R/L T20.00.2024.45.06R/L</p>	 <p>T20.00.1220.45.10R/L</p>
--	---	---	---

Broş Çekme Uçları ve Takımları / Broaching Inserts and Toolholders

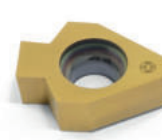
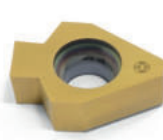
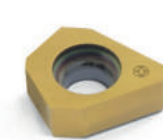
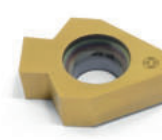
 <p>AKKO (B41-B42) UCUNA UYGUNDUR COMPATIBLE WITH AKKO (B41-B42) INSERT</p>	<p>ABT-B41-D14-Y25-L90-I040</p> <p>ABT-B41-D17-Y25-L90-I040</p> <p>ABT-B41-D17-Y25-L105-I065</p> <p>ABT-B41-D22-Y25-L100-I050</p> <p>ABT-B41-D22-Y25-L125-I070</p> <p>NEW ABT-B41-D30-Y32-L170-I110</p> <p>ABT-B42-D30-Y32-L100-I050</p> <p>ABT-B42-D30-Y32-L125-I075</p>	<p>ABT-B42-D30-Y32-L170-I110</p> <p>ABT-B42-D38-Y32-L100-I050</p> <p>ABT-B42-D38-Y32-L125-I075</p> <p>ABT-B42-D40-Y32-L100-I050</p> <p>ABT-B42-D40-Y32-L125-I075</p>	 <p>DIN6885 (Tolerans C11) torna ve freze tezgahlarında broş çekme uçları. DIN6885 (Tolerance C11) inserts for keyway broaching on lathe and milling machines.</p>	<p>B41.00.0612.085.VP3001</p> <p>B41.00.0713.085.VP3001</p> <p>B41.00.0813.105.VP3001</p> <p>B42.00.1013.105.VP3001</p> <p>B42.00.1215.135.VP3001</p> <p>B42.00.1215.175.VP3001</p> <p>B42.00.1215.225.VP3001</p>
 <p>DIN6885 (Tolerans P9) torna ve freze tezgahlarında broş çekme uçları. DIN6885 (Tolerance P9) inserts for keyway broaching on lathe and milling machines.</p>	<p>B41.00.0498.020.VP3001</p> <p>B41.00.0598.020.VP3001</p> <p>B41.00.0798.020.VP3001</p> <p>B42.00.0998.030.VP3001</p> <p>B42.00.1197.030.VP3001</p> <p>B42.00.1397.030.VP3001</p>	 <p>DIN6885 (Tolerans JS9) torna ve freze tezgahlarında broş çekme uçları. DIN6885 (Tolerance JS9) inserts for keyway broaching on lathe and milling machines.</p>	<p>B41.00.0301.020.VP3001</p> <p>B41.00.0501.020.VP3001</p> <p>B41.00.0601.020.VP3001</p> <p>B41.00.0801.020.VP3001</p> <p>B42.00.1001.030.VP3001</p> <p>B42.00.1200.050.VP3001</p> <p>B42.00.1201.030.VP3001</p> <p>B42.00.1401.030.VP3001</p>	 <p>Torna ve freze tezgahlarında kama kanalı pah kırma uçları. Inserts for keyway chamfering on lathe and milling machines.</p> <p>B41.00.0150.CH.VP3001</p> <p>B41.00.0300.CH.VP3001</p> <p>B42.00.0600.CH.VP3001</p>
 <p>DIN138 (Tolerans D10) torna ve freze tezgahlarında broş çekme uçları. DIN138 (Tolerance D10) inserts for keyway broaching on lathe and milling machines.</p>	<p>B41.00.0407.012.VP3001</p> <p>B41.00.0507.020.VP3001</p> <p>B41.00.0607.020.VP3001</p>	<p>B41.00.0808.020.VP3001</p> <p>B42.00.1008.030.VP3001</p> <p>B42.00.1210.030.VP3001</p>	<p>B42.00.1410.030.VP3001</p>	

Supap Yuvası İşleme Uçları ve Takımları / Valve Seat Inserts and Toolholders

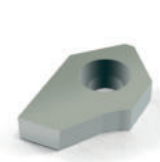
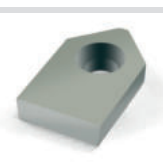
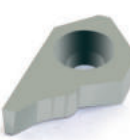

	VST-B11-2842 VST-B11-4058		VST-B11-1830-A		VST-B11-2032-A VST-B11-2434-A VST-B11-2956-A
AKKO (B11) UCUNA UYGUNDUR COMPATIBLE WITH AKKO (B11) INSERT		AKKO (B11) UCUNA UYGUNDUR COMPATIBLE WITH AKKO (B11) INSERT		AKKO (B11) UCUNA UYGUNDUR COMPATIBLE WITH AKKO (B11) INSERT	

	B11003 B11004 B11005 B11006 B11007 B11008 B11009 B11010 B11011 B11012	B11014 B11016 B11017 B11018 B11019 B11020 B11021 B11022 B11029 B11030	B11031 B11032 B11033 B11034 B11035 B11036 B11037 B11038 B11039 B11040	B11042 B11043 B11044 B11045 B11046 B11047 B11048 B11049 B11050 B11051	B11052 B11053 B11054 B11055 B11056 B11058 B11061 B11062 B11063 B11064	B11065 B11066 B11069 B11070 B11071 B11074 B11075 B11076 B11077 B11078	B11079 B11080 B11081 B11082 B11083 B11084 B11085 B11086 B11087 B11088	B11089 B11090 B11091 B11092 B11093 B11094 B11095		B11015 B11023 B11024 B11025 B11026 B11027 B11028		B11013
---	--	--	--	--	--	--	--	--	---	--	---	--------

Supap Yuvası İşleme Takımları / Valve Seat Toolholders

	ACPM-0497-165 ACPM-0498-165 ACPM-0499-165 ACPM-0500-165 ACPM-0549-165 ACPM-0550-165 ACPM-0597-165 ACPM-0598-165	ACPM-0599-165 ACPM-0600-165 ACPM-0605-165 ACPM-0606-165 ACPM-0659-165 ACPM-0660-165 ACPM-0697-165 ACPM-0698-165	ACPM-0699-165 ACPM-0700-165 ACPM-0797-165 ACPM-0798-165 ACPM-0799-165 ACPM-0800-165 ACPM-0801-165 ACPM-0802-165	ACPM-0803-165 ACPM-0824-165 ACPM-0825-165 ACPM-0849-165 ACPM-0850-165 ACPM-0897-165 ACPM-0898-165 ACPM-0899-165 ACPM-0900-165
---	--	--	--	---

Whirling Uçları ve Takımları / Whirling Inserts and Toolholders

	ATW-301-T09-D1240-Z06 ATW-302-T09-D1233-Z06 ATW-303-T09-D0620-Z06 ATW-304-T09-D1240-Z06 ATW-305-T09-D1245-Z06 ATW-306-T09-D1240-Z06	ATW-307-T09-D1250-Z06 ATW-308-T09-D1142-Z06 ATW-309-T09-D2054-Z08 ATW-310-T09-D1252-Z06 ATW-311-T09-D1252-Z06 ATW-312-T09-D1252-Z06	ATW-313-T09-D1650-Z06 ATW-314-T09-D2052-Z06 ATW-316-T09-D1252-Z06 ATW-315-T09-D0937-Z06 ATW-315-T09-D1245-Z06 ATW-318-T09-D1245-Z06		T09.HA150.D12 T09.HA200.D12 T09.HA270.D12 T09.HA350.D12 T09.HA400.D12 T09.HA450.D12 T09.HA500.D12 T09.HB400.D12 T09.HB650.D12
AKKO (T09) UCUNA UYGUNDUR COMPATIBLE WITH AKKO (T09) INSERT		Standart ISO 5835			

	T09.M200.D12 T09.M250.D12 T09.M300.D12 T09.M350.D12 T09.M400.D12 T09.M500.D12 T09.M600.D12 T09.M700.D12 T09.M800.D12		T09.HC290.D12 T09.HC350.D12 T09.HC390.D12 T09.HC420.D12		T09.HD400.D12 T09.HD450.D12
Standart ISO 5835		Standart ISO 9268		Standart ISO 9268	

Kesici Uçlar ve Takımları / Cutting Inserts and Toolholders

Polygon Frezeleme Uçları Ve Takımları / Polygon Milling Tools And Inserts

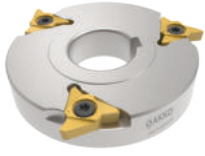

APTR/L-T12-D90-D27-Z02
APTR/L-T12-D90-D27-Z03



T12.15.0500.05.020 R/L

Nötr Profil Kanal Açma Takımları / Neutral Profile Grooving Tools

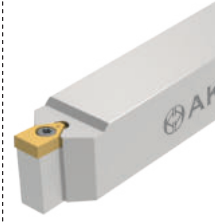

ADKT-B41-1616-L125
ADKT-B41-2020-L125
ADKT-B41-2525-L150
ADKT-B42-1616-L125
ADKT-B42-2020-L125
ADKT-B42-2525-L150

Mico Cut Uçları Ve Takımlar / Mico Cut Inserts And Tools



A12G-MC08-015
A12G-MC08-022
A12G-MC11-019
A16G-MC11-028
A16J-MC11-040



E12J-MC08-042
E12K-MC08-056
E12J-MC11-040
E16K-MC11-056
E16K-MC11-080



MC08.G.0100.010.01340
MC08.G.0150.015.01340
MC08.G.0200.020.01340
MC08.G.0250.025.01340
MC08.G.0300.030.01340



MC08.GR.0080.040.01340
MC08.GR.0120.060.01340
MC08.GR.0180.090.01340
MC08.GR.0200.100.01340
MC08.GR.0300.150.01340



MC11.G.0100.010.02040
MC11.G.0150.015.02040
MC11.G.0200.020.02040
MC11.G.0250.025.02040
MC11.G.0300.030.02040
MC11.G.0350.035.02040
MC11.G.0400.040.02040



MC11.GR.0180.090.02040
MC11.GR.0220.110.02040
MC11.GR.0300.150.02040
MC11.GR.0400.200.02040

Mimill Uçları Ve Takımları / Mimill Inserts And Tools

Ø Ds 17.7
ÇELİK ŞAFT
STEEL SHAFT



AMM-MM1803-W12-L70-S
AMM-MM1803-W16-L80-S

Ø Ds 17.7
KARBÜR ŞAFT
CARBIDE SHAFT



AMM-MM1803-W12-L100-C
AMM-MM1803-W12-L110-C
AMM-MM1803-W16-L100-C
AMM-MM1803-W16-L110-C
AMM-MM1803-W16-L125-C

Ø Ds 17.7



MM1803.G.0150.010.0177
MM1803.G.0200.020.0177
MM1803.G.0250.020.0177
MM1803.G.0300.010.0177

Ø Ds 21.7
ÇELİK ŞAFT
STEEL SHAFT



AMM-MM2203-W12-L70-S
AMM-MM2203-W16-L80-S

Ø Ds 21.7
KARBÜR ŞAFT
CARBIDE SHAFT







AMM-MM2203-W16-L100-C
AMM-MM2203-W16-L125-C
AMM-MM2203-W16-L160-C

Ø Ds 21.7

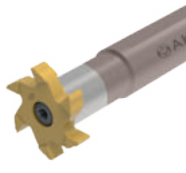

MM2203.G.0150.010.2177
MM2203.G.0200.020.2177
MM2203.G.0250.020.2177
MM2203.G.0300.020.2177
MM2203.G.0350.020.2177
MM2203.G.0400.020.2177

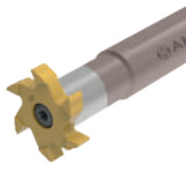
Mimill Uçları Ve Takımları / Mimill Inserts And Tools

<p>Ø Ds 27.7 ÇELİK ŞAFT STEEL SHAFT</p> 	<p>AMM-MM2806-W12-L70-S AMM-MM2806-W16-L90-S AMM-MM2806-W20-L100-S</p>	<p>Ø Ds 27.7 KARBÜR ŞAFT CARBIDE SHAFT</p> 	<p>AMM-MM2806-W16-L100-C AMM-MM2806-W16-L125-C AMM-MM2806-W20-L125-C AMM-MM2806-W20-L160-C</p>	<p>Ø Ds 27.7</p> 	<p>MM2806.G.0250.020.2770 MM2806.G.0300.020.2770 MM2806.G.0350.020.2770 MM2806.G.0400.020.2770 MM2806.G.0450.020.2770 MM2806.G.0500.020.2770</p>
<p>Ø Ds 31.7 ÇELİK ŞAFT STEEL SHAFT</p> 	<p>AMM-MM3306-W16-L90-S AMM-MM3306-W20-L100-S</p>	<p>Ø Ds 31.7 KARBÜR ŞAFT CARBIDE SHAFT</p> 	<p>AMM-MM3306-W16-L100-C AMM-MM3306-W16-L125-C AMM-MM3306-W20-L100-C AMM-MM3306-W20-L125-C AMM-MM3306-W20-L160-C</p>	<p>Ø Ds 31.7</p> 	<p>MM3306.G.0200.020.3170 MM3306.G.0250.020.3170 MM3306.G.0300.020.3170 MM3306.G.0400.020.3170</p>

S-Drill Uçları Ve Takımları / S-Drill Inserts And Toolholders

	<p>ASD-0110-0119-D5-FW20 ASD-0120-0129-D5-FW20 ASD-0130-0139-D5-FW20 ASD-0140-0149-D5-FW20 ASD-0150-0164-D5-FW20 ASD-0165-0179-D5-FW25 ASD-0180-0209-D5-FW25 ASD-0210-0244-D5-FW25 ASD-0245-0299-D5-FW25</p>	<p>ASD-0300-0349-D5-FW32 ASD-0350-0394-D5-FW32 ASD-0395-0439-D5-FW40 ASD-0440-0480-D5-FW40 ASD-0110-0119-D7-FW20 ASD-0120-0129-D7-FW20 ASD-0130-0139-D7-FW20 ASD-0140-0149-D7-FW20 ASD-0150-0164-D7-FW20</p>	<p>ASD-0165-0179-D7-FW25 ASD-0180-0209-D7-FW25 ASD-0210-0244-D7-FW25 ASD-0245-0299-D7-FW25 ASD-0300-0349-D7-FW32 ASD-0350-0394-D7-FW32 ASD-0395-0439-D7-FW40 ASD-0440-0480-D7-FW40</p>
---	--	--	--

K döküm kalite / for cast iron

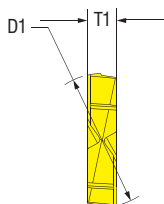
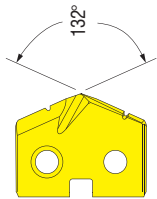

<p>ASI.M.1100.SG ASI.M.1150.SG ASI.M.1200.SG ASI.M.1250.SG ASI.M.1290.SG ASI.M.1300.SG ASI.M.1350.SG ASI.M.1400.SG ASI.M.1450.SG ASI.M.1500.SG ASI.M.1550.SG ASI.M.1600.SG ASI.M.1650.SG ASI.M.1700.SG ASI.M.1750.SG ASI.M.1790.SG ASI.M.1800.SG ASI.M.1850.SG ASI.M.1900.SG ASI.M.1950.SG</p>	<p>ASI.M.2000.SG ASI.M.2050.SG ASI.M.2100.SG ASI.M.2150.SG ASI.M.2200.SG ASI.M.2250.SG ASI.M.2300.SG ASI.M.2350.SG ASI.M.2400.SG ASI.M.2440.SG ASI.M.2450.SG ASI.M.2500.SG ASI.M.2550.SG ASI.M.2600.SG ASI.M.2650.SG ASI.M.2700.SG ASI.M.2750.SG ASI.M.2800.SG ASI.M.2850.SG ASI.M.2900.SG</p>	<p>ASI.M.2950.SG ASI.M.3000.SG ASI.M.3050.SG ASI.M.3100.SG ASI.M.3150.SG ASI.M.3200.SG ASI.M.3250.SG ASI.M.3300.SG ASI.M.3350.SG ASI.M.3400.SG ASI.M.3450.SG ASI.M.3490.SG ASI.M.3500.SG ASI.M.3550.SG ASI.M.3600.SG ASI.M.3650.SG ASI.M.3700.SG ASI.M.3750.SG ASI.M.3800.SG ASI.M.3850.SG</p>	<p>ASI.M.3900.SG ASI.M.3950.SG ASI.M.4000.SG ASI.M.4050.SG ASI.M.4100.SG ASI.M.4150.SG ASI.M.4200.SG ASI.M.4250.SG ASI.M.4300.SG ASI.M.4350.SG ASI.M.4400.SG ASI.M.4450.SG ASI.M.4500.SG ASI.M.4550.SG ASI.M.4600.SG ASI.M.4650.SG ASI.M.4700.SG ASI.M.4750.SG ASI.M.4800.SG</p>
--	--	--	--

Kesici Uçlar ve Takımları / Cutting Inserts and Toolholders

Torx - Alyan / Punch - Kazıma Takımları / Torx-Allen / Punch - Broach Set



APTX-006
APTX-008
APTX-010
APTX-015
APTX-020
APTX-025

APTX-030
APTX-040
APTX-045
APTX-050



APHX-0015
APHX-0020
APHX-0025
APHX-0030
APHX-0035
APHX-0040
APHX-0045
APHX-0050

APHX-0060
APHX-0080
APHX-0100



AKTX-006
AKTX-008
AKTX-010
AKTX-015
AKTX-020
AKTX-030
AKTX-040
AKTX-045

AKTX-050
AKTX-055
AKTX-060
AKTX-070
AKTX-080
AKTX-090
AKTX-100



AKHX-002-002
AKHX-003-003
AKHX-004-006
AKHX-007-012



Diş Açma Frezeleme Uçları / Thread Milling Insert



C14

ADTI.14.050
ADTI.14.075
ADTE.14.075
ADTI.14.100
ADTE.14.100
ADTI.14.125
ADTE.14.125
ADTI.14.150

ADTE.14.150
ADTI.14.175
ADTE.14.175
ADTI.14.200
ADTE.14.200
ADTI.14.250
ADTE.14.250



C21

ADTI.21.100
ADTE.21.100
ADTI.21.150
ADTE.21.150
ADTI.21.175
ADTI.21.200
ADTE.21.200
ADTI.21.250

ADTE.21.250
ADTI.21.300
ADTE.21.300
ADTI.21.350

Segman Uçları Ve Takımları / Ring Inserts And Toolholders



ASFM-T12-D40x5.2-A22-Z04
ASFM-T12-D60x5.2-A22-Z04



ASEM-T12-D45-W25-L125-Z03-H



ASK-125-13
ASK-135-13
ASK-145-13
ASK-150-13
ASK-165-18
ASK-175-18
ASK-185-23
ASK-200-23

ASK-220-33
ASK-230-33
ASK-250-33
ASK-265-33
ASK-270-33
ASK-280-33
ASK-300-33
ASK-320-33



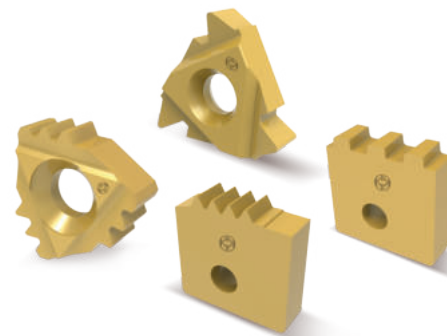









ASK-330-33
ASK-350-38
ASK-370-38
ASK-390-38
ASK-400-38

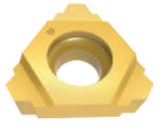

Ayarlanabilir Bara Uçları / Adjustable Boring Inserts

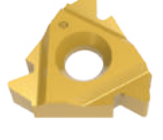
 <p>CCGT 09T302L-AC1020 CCGT 09T304L-AC1020</p>	 <p>TPGH 09T0202L-AC1020 TPGH 09T0204L-AC1020</p>	 <p>WCGT 020102L-AC1020 WCGT 020104L-AC1020</p>
--	--	--

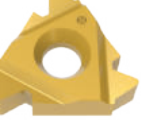
Diş Açma Uçları / Threading Inserts

<p>ROUND Dış çap / External</p>  <p>16ST ER/L 10RD 16ST ER/L 8RD 16ST ER/L 6RD 22ST ER/L 6RD 22ST ER/L 4RD 27ST ER/L 4RD</p>	<p>ROUND İç çap / Internal</p>  <p>16ST IR/L 10RD 16ST IR/L 8RD 16ST IR/L 6RD 22ST IR/L 6RD 22ST IR/L 4RD 27ST IR/L 4RD</p>	<p>TRAPEZ Dış çap / External</p>  <p>16ST ER/L 1.5TR 16ST ER/L 2.0TR 16ST ER/L 2.5TR 16ST ER/L 3.0TR 22ST ER/L 4.0TR 22ST ER/L 5.0TR 22ST ER/L 6.0TR 27ST ER/L 6.0TR</p>
<p>TRAPEZ Dış çap / External V Tip / V Type</p>  <p>27VT ER/L 6.0TR 27VT ER/L 7.0TR 27VT ER/L 8.0TR</p>	<p>TRAPEZ Dış çap / External U Tip / U Type</p>  <p>22UT E 6.0TR 22UT E 7.0TR 22UT E 8.0TR 27UT E 8.0TR 27UT E 9.0TR</p>	<p>TRAPEZ İç çap / Internal</p>  <p>16ST IR/L 1.5TR 16ST IR/L 2.0TR 16ST IR/L 2.5TR 16ST IR/L 3.0TR 22ST IR/L 4.0TR 22ST IR/L 5.0TR 22ST IR/L 6.0TR 27ST IR/L 6.0TR</p>
<p>TRAPEZ İç çap / Internal V Tip / V Type</p>  <p>27VT IR/L 6.0TR 27VT IR/L 7.0TR 27VT IR/L 8.0TR</p>	<p>TRAPEZ İç çap / Internal U Tip / U Type</p>  <p>22UT I 6.0TR 22UT I 7.0TR 22UT I 8.0TR 27UT I 8.0TR 27UT I 9.0TR</p>	<p>OIL AND GAS INDUSTRY Dış çap / External</p>  <p>22ST ER 4APIV382 22ST ER 4APIV383 22ST ER 4APIV502 22ST ER 4APIV503 22ST ER 5APIV403 22ST ER 6APIV551 27ST ER 4APIV382 27ST ER 4APIV383 27ST ER 4APIV502 27ST ER 4APIV503 27ST ER 5APIV403 27ST ER 4APIV652</p>
<p>OIL AND GAS INDUSTRY Dış çap / External V Tip / V Type</p>  <p>27VT ER 5API403</p>	<p>OIL AND GAS INDUSTRY İç çap / Internal</p>  <p>22ST IR 4APIV382 22ST IR 4APIV383 22ST IR 4APIV502 22ST IR 4APIV503 22ST IR 5APIV403 22ST IR 5APIV551 27ST IR 4APIV382 27ST IR 4APIV383 27ST IR 4APIV502 27ST IR 4APIV503 27ST IR 5APIV403 27ST IR 4APIV652</p>	<p>OIL AND GAS INDUSTRY İç çap / Internal V Tip / V Type</p>  <p>27VT IR 5API403</p>

Mini Cut Takımlar / Mini Cut Tools



APB..

Delik İçi Mini Cut Takımlar / Mini Cut Boring

APB.04.102.015.32	APB.04.406.020	APB.06.305.020
APB.04.152.015.32	APB.05.102.020	APB.06.356.020
APB.04.203.015.32	APB.05.152.020	APB.06.406.020
APB.04.254.015.32	APB.05.203.020	APB.06.508.020
APB.04.305.015.32	APB.05.254.020	APB.07.254.020
APB.04.356.015.32	APB.05.305.020	APB.07.305.020
APB.04.102.015	APB.05.356.020	APB.07.356.020
APB.04.152.015	APB.05.406.020	APB.07.406.020
APB.04.203.015	APB.06.102.020	APB.07.508.020
APB.04.254.015	APB.06.152.020	APB.07.608.020
APB.04.305.015	APB.06.203.020	
APB.04.356.015	APB.06.254.020	

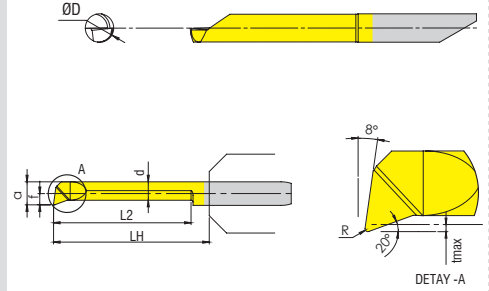

DETAY - A

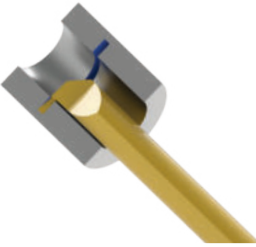

APG..

Kanal Açma Mini Cut Takımlar / Mini Cut Grooving

APG04.080.102	APG05.200.203	APG06.200.102	APG07.198.203
APG04.080.152	APG05.200.254	APG06.200.152	APG07.198.254
APG04.080.203	APG05.200.305	APG06.200.203	APG07.198.305
APG04.080.254	APG06.079.102	APG06.200.254	APG07.198.356
APG04.100.102	APG06.079.152	APG06.200.305	APG07.200.102
APG04.100.152	APG06.079.203	APG06.200.356	APG07.200.152
APG04.100.203	APG06.079.254	APG07.079.102	APG07.200.203
APG05.079.102	APG06.079.305	APG07.079.152	APG07.200.254
APG05.079.152	APG06.079.356	APG07.079.203	APG07.200.305
APG05.079.203	APG06.100.102	APG07.079.254	APG07.200.356
APG05.079.254	APG06.100.152	APG07.079.305	APG10.100.305
APG05.079.305	APG06.100.203	APG07.079.356	APG10.100.508
APG05.079.356	APG06.100.254	APG07.079.406	APG10.200.305
APG05.100.102	APG06.100.305	APG07.100.102	APG10.200.508
APG05.100.152	APG06.100.356	APG07.100.152	APG10.300.305
APG05.100.203	APG06.100.406	APG07.100.203	APG10.300.508
APG05.100.254	APG06.117.102	APG07.100.254	APG04.100.152.R050
APG05.100.305	APG06.117.152	APG07.100.305	APG04.117.152.R0585
APG05.100.356	APG06.117.203	APG07.100.356	APG05.100.203.R050
APG05.117.102	APG06.117.254	APG07.100.406	APG05.117.203.R0585
APG05.117.152	APG06.117.305	APG07.117.102	APG05.150.203.R075
APG05.117.203	APG06.117.356	APG07.117.152	APG05.1574.203.R0787
APG05.117.254	APG06.117.406	APG07.117.203	APG05.1626.203.R0813
APG05.117.305	APG06.150.102	APG07.117.254	APG05.198.203.R099
APG05.117.356	APG06.150.152	APG07.117.305	APG05.200.203.R100
APG05.150.102	APG06.150.203	APG07.117.356	APG06.100.254.R050
APG05.150.152	APG06.150.254	APG07.117.406	APG06.117.254.R0585
APG05.150.203	APG06.150.305	APG07.150.102	APG06.150.254.R075
APG05.150.254	APG06.150.356	APG07.150.152	APG06.1574.254.R0787
APG05.150.305	APG06.157.102	APG07.150.203	APG06.1626.254.R0813
APG05.150.356	APG06.157.152	APG07.150.254	APG06.198.254.R099
APG05.157.102	APG06.157.203	APG07.150.305	APG06.200.203.R100
APG05.157.152	APG06.157.254	APG07.150.356	APG06.200.254.R100
APG05.157.203	APG06.157.305	APG07.150.406	APG07.100.305.R050
APG05.157.254	APG06.157.356	APG07.157.102	APG07.117.305.R0585
APG05.157.305	APG06.157.406	APG07.157.152	APG07.150.305.R075
APG05.198.102	APG06.198.102	APG07.157.203	APG07.1574.305.R0787
APG05.198.152	APG06.198.152	APG07.157.254	APG07.1626.305.R0813
APG05.198.203	APG06.198.203	APG07.157.305	APG07.198.305.R099
APG05.198.254	APG06.198.254	APG07.157.356	APG07.200.305.R100
APG05.198.305	APG06.198.305	APG07.157.406	
APG05.200.102	APG06.198.356	APG07.198.102	
APG05.200.152	APG06.198.406	APG07.198.152	

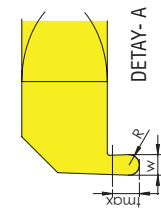
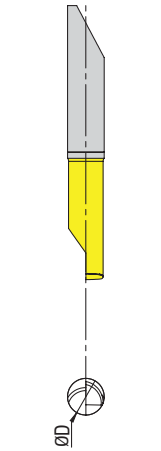

DETAY - A

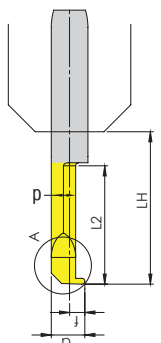

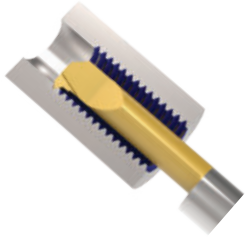

APT..

Dış Çekme Mini Cut Takımlar / Mini Cut Threading

APT.04.152.080
APT.04.152.050
APT.05.152.075
APT.05.152.100
APT.05.203.100
APT.05.254.100
APT.05.152.050

APT.06.152.125
APT.06.152.150
APT.06.152.175
APT.06.203.125
APT.06.254.125
APT.06.203.175
APT.06.254.175

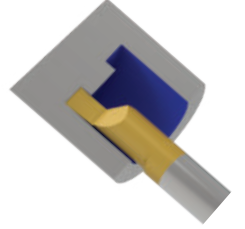
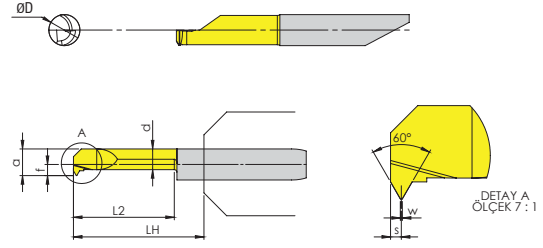

APFG..

Alın Kanal Açma Mini Cut Takımlar / Mini Cut Face Grooving

APFG.06.152.0787 R005
APFG.06.152.1000 R005
APFG.06.152.1500 R005
APFG.06.152.1000 R015
APFG.06.152.1168 R015
APFG.06.152.1500 R015
APFG.06.152.1575 R015

APFG.06.152.1981 R015
APFG.06.152.2000 R015
APFG.06.152.2388 R015
APFG.06.152.2500 R015
APFG.06.152.3000 R015
APFG.06.152.3175 R015

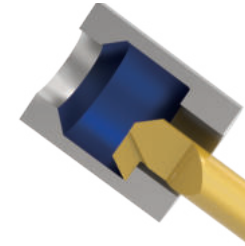
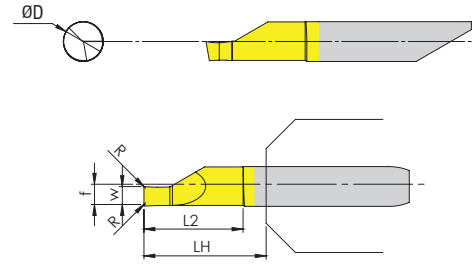

APB..

Ters Tornalama Mini Cut Takımlar / Mini Cut Back Boring

APB.B04.152.010.32
APB.B04.203.010.32
APB.B04.152.015.42
APB.B04.254.015.42
APB.B05.203.020.52
APB.B05.305.020.52
APB.B06.203.020.62

APB.B06.305.020.62
APB.B07.203.020.72
APB.B07.305.020.72

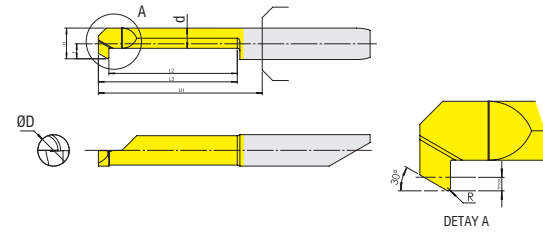

**Mini Cut Takımlar
Mini Cut Tools**



Tutucular / Holders



ABT..

JIS B 6339 (MAS 403 BT) / BT VELDON ŞAFTLI TAKIM TUTUCULAR / JIS B 6339 (MAS 403 BT) / BT END MILL HOLDER

ABT30-EM-06-050	ABT40-EM-10-160	ABT40-EM-20-160	ABT50-EM-10-100	ABT50-EM-25-100
ABT30-EM-08-050	ABT40-EM-12-063	ABT40-EM-25-090	ABT50-EM-10-160	ABT50-EM-25-160
ABT30-EM-10-050	ABT40-EM-12-100	ABT40-EM-25-130	ABT50-EM-12-080	ABT50-EM-32-105
ABT30-EM-12-050	ABT40-EM-12-160	ABT40-EM-25-160	ABT50-EM-12-100	ABT50-EM-32-160
ABT30-EM-14-050	ABT40-EM-14-063	ABT40-EM-32-100	ABT50-EM-12-160	ABT50-EM-40-110
ABT30-EM-16-065	ABT40-EM-14-100	ABT40-EM-32-130	ABT50-EM-14-080	ABT50-EM-40-160
ABT30-EM-18-065	ABT40-EM-14-160	ABT40-EM-32-160	ABT50-EM-14-100	
ABT40-EM-06-050	ABT40-EM-16-063	ABT40-EM-40-120	ABT50-EM-14-160	
ABT40-EM-06-100	ABT40-EM-16-100	ABT50-EM-06-070	ABT50-EM-16-080	
ABT40-EM-06-160	ABT40-EM-16-160	ABT50-EM-06-100	ABT50-EM-16-100	
ABT40-EM-08-050	ABT40-EM-18-065	ABT50-EM-06-160	ABT50-EM-16-160	
ABT40-EM-08-100	ABT40-EM-18-100	ABT50-EM-08-070	ABT50-EM-18-100	
ABT40-EM-08-160	ABT40-EM-18-160	ABT50-EM-08-100	ABT50-EM-18-160	
ABT40-EM-10-063	ABT40-EM-20-063	ABT50-EM-08-160	ABT50-EM-20-100	
ABT40-EM-10-100	ABT40-EM-20-100	ABT50-EM-10-070	ABT50-EM-20-160	



M

ABT..

JIS B 6339 (MAS 403 BT) / BT ER SIKMA PENSLİ TAKIM TUTUCULAR / JIS B 6339 (MAS 403 BT) / BT COLLET CHUCKS ER

ABT30-ER-16-060	ABT40-ER-25-130	ABT50-ER-16-160	ABT50-ER-40-080
ABT30-ER-16-100	ABT40-ER-32-070	ABT50-ER-25-070	ABT50-ER-40-100
ABT30-ER-25-060	ABT40-ER-32-100	ABT50-ER-25-100	ABT50-ER-40-160
ABT30-ER-25-100	ABT40-ER-32-160	ABT50-ER-25-130	
ABT40-ER-16-063	ABT40-ER-40-080	ABT50-ER-25-160	ABT40-ER-16-100-M
ABT40-ER-16-100	ABT40-ER-40-100	ABT50-ER-32-070	ABT40-ER-16-130-M
ABT40-ER-16-130	ABT40-ER-40-160	ABT50-ER-32-100	ABT50-ER-16-100-M
ABT40-ER-25-060	ABT50-ER-16-070	ABT50-ER-32-130	ABT50-ER-16-130-M
ABT40-ER-25-100	ABT50-ER-16-100	ABT50-ER-32-160	ABT50-ER-16-160-M

M (mini) : JIS B 6339 (MAS 403 BT) / BT ER MİNİ SIKMA PENSLİ TAKIM TUTUCULAR
M (mini) : JIS B 6339 (MAS 403 BT) / BT COLLET CHUCKS ER MİNİ



ABT..

JIS B 6339 (MAS 403 BT) BT YÜZEY FREZE TAKIM TUTUCULAR JIS B 6339 (MAS 403 BT) BT SHELL MILL HOLDER

ABT30-FM-16-040	ABT40-FM-40-100
ABT30-FM-22-040	ABT50-FM-16-050
ABT30-FM-27-050	ABT50-FM-16-055
ABT30-FM-32-050	ABT50-FM-16-100
ABT40-FM-16-055	ABT50-FM-16-160
ABT40-FM-16-100	ABT50-FM-22-055
ABT40-FM-22-040	ABT50-FM-22-100
ABT40-FM-22-055	ABT50-FM-22-160
ABT40-FM-22-100	ABT50-FM-27-055
ABT40-FM-27-055	ABT50-FM-27-100
ABT40-FM-27-100	ABT50-FM-27-160
ABT40-FM-32-050	ABT50-FM-32-100
ABT40-FM-32-060	ABT50-FM-32-160
ABT40-FM-32-100	ABT50-FM-40-100
ABT40-FM-40-050	ABT50-FM-40-160
ABT40-FM-40-060	ABT50-FM-60-080



ABT..

JIS B 6339 (MAS 403 BT) / BT MODÜLER PARMAK FREZE TUTUCULAR JIS B 6339 (MAS 403 BT) / BT MILLING CUTTER ARBORS FOR SCREW-ON TYPE MILLING CUTTERS

ABT40-MM-06-052	ABT40-MM-16-077
ABT40-MM-06-077	ABT40-MM-16-102
ABT40-MM-06-102	ABT40-MM-16-127
ABT40-MM-08-052	ABT40-MM-16-152
ABT40-MM-08-077	ABT40-MM-16-177
ABT40-MM-08-102	ABT50-MM-08-088
ABT40-MM-08-127	ABT50-MM-08-138
ABT40-MM-10-052	ABT50-MM-08-188
ABT40-MM-10-077	ABT50-MM-10-088
ABT40-MM-10-102	ABT50-MM-10-138
ABT40-MM-10-127	ABT50-MM-10-188
ABT40-MM-12-052	ABT50-MM-12-088
ABT40-MM-12-077	ABT50-MM-12-138
ABT40-MM-12-102	ABT50-MM-12-188
ABT40-MM-12-127	ABT50-MM-16-088
ABT40-MM-12-177	ABT50-MM-16-138
ABT40-MM-16-052	ABT50-MM-16-188



ABT..

JIS B 6339 (MAS 403 BT) / BT KOMBİNE YÜZEY FREZE TUTUCULAR JIS B 6339 (MAS 403 BT) / BT FOR COMBI SHELL MILL HOLDER

ABT30-FMC-16-045	ABT40-FMC-27-160	ABT50-FMC-27-100
ABT30-FMC-22-047	ABT40-FMC-32-060	ABT50-FMC-27-130
ABT30-FMC-27-049	ABT40-FMC-32-100	ABT50-FMC-27-160
ABT30-FMC-32-052	ABT40-FMC-32-130	ABT50-FMC-32-070
ABT40-FMC-16-055	ABT40-FMC-32-160	ABT50-FMC-32-100
ABT40-FMC-16-100	ABT40-FMC-40-060	ABT50-FMC-32-130
ABT40-FMC-16-130	ABT50-FMC-16-070	ABT50-FMC-32-160
ABT40-FMC-16-160	ABT50-FMC-16-100	ABT50-FMC-40-070
ABT40-FMC-22-055	ABT50-FMC-16-130	ABT50-FMC-40-100
ABT40-FMC-22-100	ABT50-FMC-16-160	ABT50-FMC-40-130
ABT40-FMC-22-130	ABT50-FMC-22-070	ABT50-FMC-40-160
ABT40-FMC-22-160	ABT50-FMC-22-100	
ABT40-FMC-27-055	ABT50-FMC-22-130	
ABT40-FMC-27-100	ABT50-FMC-22-160	
ABT40-FMC-27-130	ABT50-FMC-27-070	



ABT..

BT BLANK TUTUCULAR BT BLANK HOLDERS

ABT40-BL41-63-250
ABT50-BL41-97-315



ABBT..

JIS B 6339 (MAS 403 BT) / AK-PLUS VELDON SAFTLI TAKIM TUTUCULAR / JIS B 6339 (MAS 403 BT) / AK-PLUS END MILL HOLDER

ABBT30-EM-06-050
ABBT30-EM-08-050
ABBT30-EM-10-050
ABBT30-EM-12-050
ABBT30-EM-14-050
ABBT30-EM-16-063
ABBT30-EM-18-063
ABBT40-EM-06-100
ABBT40-EM-06-160
ABBT40-EM-08-050
ABBT40-EM-08-100
ABBT40-EM-08-160
ABBT40-EM-10-063
ABBT40-EM-10-100

ABBT40-EM-12-063
ABBT40-EM-12-100
ABBT40-EM-14-063
ABBT40-EM-14-100
ABBT40-EM-16-063
ABBT40-EM-16-100
ABBT40-EM-16-160
ABBT40-EM-18-063
ABBT40-EM-18-100
ABBT40-EM-20-063
ABBT40-EM-20-100
ABBT40-EM-25-090
ABBT40-EM-25-130
ABBT40-EM-25-160

ABBT40-EM-32-100
ABBT40-EM-32-160
ABBT40-EM-40-120
ABBT50-EM-06-063
ABBT50-EM-06-100
ABBT50-EM-06-160
ABBT50-EM-08-063
ABBT50-EM-08-100
ABBT50-EM-10-100
ABBT50-EM-10-160
ABBT50-EM-12-080
ABBT50-EM-12-100
ABBT50-EM-12-160
ABBT50-EM-14-080

ABBT50-EM-14-100
ABBT50-EM-16-080
ABBT50-EM-16-100
ABBT50-EM-16-160
ABBT50-EM-18-100
ABBT50-EM-18-160
ABBT50-EM-20-100
ABBT50-EM-20-160
ABBT50-EM-25-100
ABBT50-EM-25-160
ABBT50-EM-32-105
ABBT50-EM-32-160
ABBT50-EM-40-110
ABBT50-EM-40-160



ABBT..

**JIS B 6339 (MAS 403 BT) / AK-PLUS ER SIKMA PENSLI TAKIM TUTUCULAR
JIS B 6339 (MAS 403 BT) / AK-PLUS COLLET CHUCKS ER**

ABBT30-ER-16-070
ABBT30-ER-16-100
ABBT30-ER-25-070
ABBT30-ER-25-100
ABBT40-ER-16-063
ABBT40-ER-16-100
ABBT40-ER-16-130
ABBT40-ER-25-060
ABBT40-ER-25-100
ABBT40-ER-25-130
ABBT40-ER-32-070
ABBT40-ER-32-100
ABBT40-ER-32-160
ABBT40-ER-40-080
ABBT40-ER-40-100
ABBT40-ER-40-160

ABBT50-ER-16-070
ABBT50-ER-16-100
ABBT50-ER-16-160
ABBT50-ER-25-070
ABBT50-ER-25-100
ABBT50-ER-25-160
ABBT50-ER-32-070
ABBT50-ER-32-100
ABBT50-ER-32-130
ABBT50-ER-32-160
ABBT50-ER-40-080
ABBT50-ER-40-100
ABBT50-ER-40-160



ABBT..

**JIS B 6339 (MAS 403 BT) / AK-PLUS ER MINİ SIKMA PENSLİ TAKIM TUTUCULARI
JIS B 6339 (MAS 403 BT) / AK-PLUS COLLET CHUCKS ER MINI**

ABBT40-ER-16-100-M
ABBT40-ER-16-130-M
ABBT50-ER-16-130-M
ABBT50-ER-16-160-M



ABBT..

**JIS B 6339 (MAS 403 BT) / AK-PLUS YÜZEY FREZE TAKIM TUTUCULAR
JIS B 6339 (MAS 403 BT) / AK-PLUS SHELL MILL HOLDER**

ABBT30-FM-16-040
ABBT30-FM-22-040
ABBT30-FM-27-050
ABBT30-FM-32-050
ABBT40-FM-16-100
ABBT40-FM-22-100
ABBT40-FM-27-100
ABBT40-FM-32-100
ABBT50-FM-16-050
ABBT50-FM-16-100
ABBT50-FM-16-160
ABBT50-FM-22-055
ABBT50-FM-22-100
ABBT50-FM-22-160
ABBT50-FM-27-055
ABBT50-FM-27-100

ABBT50-FM-27-160
ABBT50-FM-32-100
ABBT50-FM-32-160
ABBT50-FM-40-100
ABBT50-FM-40-160
ABBT50-FM-60-080



ABBT..

**JIS B 6339 (MAS 403 BT) / AK-PLUS MODÜLER PARMAK FREZE TUTUCULAR
JIS B 6339 (MAS 403 BT) / AK-PLUS MILLING CUTTER ARBORS FOR SCREW-ON TYPE MILLING CUTTERS**

ABBT40-MM-08-052
ABBT40-MM-08-077
ABBT40-MM-08-102
ABBT40-MM-08-127
ABBT40-MM-10-052
ABBT40-MM-10-077
ABBT40-MM-10-102
ABBT40-MM-10-127
ABBT40-MM-12-052
ABBT40-MM-12-077
ABBT40-MM-12-102
ABBT40-MM-12-127
ABBT40-MM-12-177
ABBT40-MM-16-052
ABBT40-MM-16-077
ABBT40-MM-16-102
ABBT40-MM-16-127

ABBT40-MM-16-152
ABBT40-MM-16-177
ABBT50-MM-08-138
ABBT50-MM-08-188
ABBT50-MM-10-088
ABBT50-MM-10-138
ABBT50-MM-10-188
ABBT50-MM-12-088
ABBT50-MM-12-138
ABBT50-MM-12-188
ABBT50-MM-16-088
ABBT50-MM-16-138
ABBT50-MM-16-188



ABBT..

**JIS B 6339 (MAS 403 BT) / AK-PLUS KOMBİNE YÜZEY FREZE TUTUCULAR
JIS B 6339 (MAS 403 BT) / AK-PLUS COMBI SHELL MILL HOLDER**

ABBT30-FMC-16-045
ABBT30-FMC-22-047
ABBT30-FMC-27-049
ABBT30-FMC-32-052
ABBT40-FMC-16-055
ABBT40-FMC-16-100
ABBT40-FMC-16-160

ABBT40-FMC-22-055
ABBT40-FMC-22-100
ABBT40-FMC-27-055
ABBT40-FMC-27-100
ABBT40-FMC-32-060
ABBT40-FMC-32-100
ABBT40-FMC-40-060

ABBT50-FMC-16-070
ABBT50-FMC-16-100
ABBT50-FMC-16-130
ABBT50-FMC-16-160
ABBT50-FMC-22-070
ABBT50-FMC-22-100
ABBT50-FMC-22-130

ABBT50-FMC-22-160
ABBT50-FMC-27-070
ABBT50-FMC-27-100
ABBT50-FMC-27-130
ABBT50-FMC-27-160
ABBT50-FMC-32-070
ABBT50-FMC-32-100

ABBT50-FMC-32-130
ABBT50-FMC-32-160
ABBT50-FMC-40-070
ABBT50-FMC-40-100
ABBT50-FMC-40-130
ABBT50-FMC-40-160

Tutucular / Holders

ASK..

DIN ISO 7388-1 (SK DIN 69871)
SK VELDON SAFTLI TAKIM TUTUCULAR
DIN ISO 7388-1 (SK DIN 69871)
SK END MILL HOLDER
 ASK40-EM-08-050
 ASK40-EM-10-063
 ASK40-EM-12-050
 ASK40-EM-12-100
 ASK40-EM-12-063
 ASK40-EM-16-063
 ASK40-EM-16-100
 ASK40-EM-20-063
 ASK40-EM-20-100
 ASK40-EM-25-100
 ASK40-EM-32-100
 ASK40-EM-40-120

ASK..

DIN ISO 7388-1 (SK DIN 69871)
SK ER SIKMA PENSLI TAKIM TUTUCULAR
DIN ISO 7388-1 (SK DIN 69871)
SK COLLET CHUCKS ER
 ASK40-ER-16-063
 ASK40-ER-25-060
 ASK40-ER-25-100
 ASK40-ER-32-070
 ASK40-ER-32-100
 ASK40-ER-32-160
 ASK40-ER-40-080
 ASK40-ER-40-100
 ASK40-ER-40-160

ASK..

DIN ISO 7388-1 (SK DIN 69871)
SK YÜZEY FREZE TAKIM TUTUCULAR
DIN ISO 7388-1 (SK DIN 69871)
SK SHELL MILL HOLDER
 ASK40-FM-16-055
 ASK40-FM-16-100
 ASK40-FM-22-055
 ASK40-FM-27-055
 ASK40-FM-32-060
 ASK40-FM-40-060

AHSK..

ISO 12164-1 / HSK ER MİNİ SIKMA PENSLİ TAKIM TUTUCULAR
ISO 12164-1 / HSK COLLET CHUCKS ER MİNİ
 AHSKA50-ER-16-100-M
 AHSKA63-ER-16-100-M
 AHSKA63-ER-16-160-M

AHSK..

ISO 12164-1 / HSK VELDON SAFTLI TAKIM TUTUCULAR
ISO 12164-1 / HSK END MILL HOLDER

AHSKA32-EM-06-060	AHSKA63-EM-06-100	AHSKA63-EM-20-100	AHSKA100-EM-10-080
AHSKA32-EM-08-060	AHSKA63-EM-06-160	AHSKA63-EM-20-130	AHSKA100-EM-10-160
AHSKA32-EM-10-065	AHSKA63-EM-08-075	AHSKA63-EM-20-160	AHSKA100-EM-12-080
AHSKA32-EM-12-065	AHSKA63-EM-08-100	AHSKA63-EM-25-110	AHSKA100-EM-12-160
AHSKA40-EM-06-060	AHSKA63-EM-08-160	AHSKA63-EM-32-110	AHSKA100-EM-14-080
AHSKA40-EM-08-060	AHSKA63-EM-10-075	AHSKA80-EM-06-080	AHSKA100-EM-14-160
AHSKA40-EM-10-060	AHSKA63-EM-10-100	AHSKA80-EM-08-080	AHSKA100-EM-16-100
AHSKA40-EM-12-070	AHSKA63-EM-10-160	AHSKA80-EM-10-080	AHSKA100-EM-16-160
AHSKA40-EM-16-075	AHSKA63-EM-12-080	AHSKA80-EM-12-080	AHSKA100-EM-18-100
AHSKA50-EM-06-065	AHSKA63-EM-12-100	AHSKA80-EM-14-080	AHSKA100-EM-18-160
AHSKA50-EM-08-065	AHSKA63-EM-12-130	AHSKA80-EM-16-100	AHSKA100-EM-20-100
AHSKA50-EM-10-065	AHSKA63-EM-12-160	AHSKA80-EM-18-100	AHSKA100-EM-20-160
AHSKA50-EM-12-080	AHSKA63-EM-14-080	AHSKA80-EM-20-100	AHSKA100-EM-25-100
AHSKA50-EM-14-080	AHSKA63-EM-14-130	AHSKA80-EM-25-100	AHSKA100-EM-25-160
AHSKA50-EM-16-080	AHSKA63-EM-16-080	AHSKA80-EM-32-110	AHSKA100-EM-32-100
AHSKA50-EM-18-080	AHSKA63-EM-16-130	AHSKA100-EM-06-080	AHSKA100-EM-32-160
AHSKA50-EM-20-080	AHSKA63-EM-16-160	AHSKA100-EM-06-160	AHSKA100-EM-40-105
AHSKA63-EM-06-065	AHSKA63-EM-18-080	AHSKA100-EM-08-080	AHSKA100-EM-40-160
AHSKA63-EM-06-075	AHSKA63-EM-20-080	AHSKA100-EM-08-160	

AHSK..

ISO 12164-1 / HSK ER SIKMA PENSLİ TAKIM TUTUCULAR
ISO 12164-1 / HSK COLLET CHUCKS ER

AHSKA32-ER-16-080	AHSKA63-ER-16-075	AHSKA63-ER-40-085	AHSKA100-ER-25-160
AHSKA32-ER-25-080	AHSKA63-ER-16-100	AHSKA63-ER-40-100	AHSKA100-ER-32-100
AHSKA40-ER-16-060	AHSKA63-ER-16-160	AHSKA63-ER-40-160	AHSKA100-ER-32-160
AHSKA40-ER-25-060	AHSKA63-ER-25-100	AHSKA80-ER-32-100	AHSKA100-ER-40-120
AHSKA40-ER-32-100	AHSKA63-ER-25-160	AHSKA80-ER-40-120	AHSKA100-ER-40-160
AHSKA50-ER-16-100	AHSKA63-ER-32-075	AHSKA100-ER-16-100	
AHSKA50-ER-25-100	AHSKA63-ER-32-100	AHSKA100-ER-16-160	
AHSKA50-ER-32-100	AHSKA63-ER-32-160	AHSKA100-ER-25-100	

ISO 12164-1 / HSK YÜZEY FREZE TAKIM TUTUCULAR
ISO 12164-1 / HSK SHELL MILL HOLDER



AHSK..

AHSKA50-FM-16-050	AHSKA80-FM-22-100
AHSKA50-FM-16-100	AHSKA80-FM-27-100
AHSKA50-FM-22-060	AHSKA80-FM-32-100
AHSKA50-FM-22-100	AHSKA80-FM-40-100
AHSKA50-FM-27-060	AHSKA100-FM-16-160
AHSKA50-FM-32-060	AHSKA100-FM-22-100
AHSKA63-FM-16-050	AHSKA100-FM-22-160
AHSKA63-FM-16-100	AHSKA100-FM-27-100
AHSKA63-FM-22-050	AHSKA100-FM-27-160
AHSKA63-FM-22-100	AHSKA100-FM-32-100
AHSKA63-FM-27-060	AHSKA100-FM-32-160
AHSKA63-FM-27-100	AHSKA100-FM-40-100
AHSKA63-FM-32-060	AHSKA100-FM-40-160
AHSKA63-FM-32-100	

ISO 12164-1 / HSK MODÜLER PARMAK FREZE TUTUCULAR
ISO 12164-1 / HSK MILLING CUTTER ARBORS FOR
SCREW-ON TYPE MILLING CUTTERS



AHSK..

AHSKA63-MM-10-076	AHSKA100-MM-12-079
AHSKA63-MM-10-126	AHSKA100-MM-12-129
AHSKA63-MM-10-176	AHSKA100-MM-12-179
AHSKA63-MM-12-076	AHSKA100-MM-16-079
AHSKA63-MM-12-101	AHSKA100-MM-16-129
AHSKA63-MM-12-126	AHSKA100-MM-16-179
AHSKA63-MM-12-176	
AHSKA63-MM-16-076	
AHSKA63-MM-16-101	
AHSKA63-MM-16-126	
AHSKA63-MM-16-176	
AHSKA100-MM-10-079	
AHSKA100-MM-10-129	
AHSKA100-MM-10-179	

ISO 12164-1 / HSK KOMBİNE YÜZEY FREZE TUTUCULAR / ISO 12164-1 / HSK COMBI SHELL MILL HOLDER



AHSK..

AHSKA32-FMC-16-055	AHSKA63-FMC-22-060	AHSKA80-FMC-27-060	AHSKA100-FMC-27-060
AHSKA32-FMC-22-055	AHSKA63-FMC-22-100	AHSKA80-FMC-32-060	AHSKA100-FMC-27-100
AHSKA32-FMC-27-065	AHSKA63-FMC-22-160	AHSKA80-FMC-40-070	AHSKA100-FMC-27-130
AHSKA40-FMC-16-050	AHSKA63-FMC-27-060	AHSKA100-FMC-16-060	AHSKA100-FMC-27-160
AHSKA40-FMC-22-050	AHSKA63-FMC-27-100	AHSKA100-FMC-16-100	AHSKA100-FMC-27-200
AHSKA40-FMC-27-065	AHSKA63-FMC-32-060	AHSKA100-FMC-16-130	AHSKA100-FMC-32-060
AHSKA50-FMC-16-050	AHSKA63-FMC-32-100	AHSKA100-FMC-16-160	AHSKA100-FMC-32-100
AHSKA50-FMC-22-050	AHSKA63-FMC-32-160	AHSKA100-FMC-16-200	AHSKA100-FMC-32-130
AHSKA50-FMC-27-065	AHSKA63-FMC-40-070	AHSKA100-FMC-22-060	AHSKA100-FMC-32-160
AHSKA50-FMC-32-065	AHSKA63-FMC-40-100	AHSKA100-FMC-22-100	AHSKA100-FMC-40-070
AHSKA63-FMC-16-060	AHSKA63-FMC-40-160	AHSKA100-FMC-22-130	AHSKA100-FMC-40-100
AHSKA63-FMC-16-100	AHSKA80-FMC-16-060	AHSKA100-FMC-22-160	AHSKA100-FMC-40-130
AHSKA63-FMC-16-160	AHSKA80-FMC-22-060	AHSKA100-FMC-22-200	AHSKA100-FMC-40-160

HSK BLANK TUTUCULAR
HSK BLANK HOLDERS



AHSK..

AHSKA32-BL41-025-150
AHSKA32-BL41-032-100
AHSKA40-BL41-040-150
AHSKA40-BL41-070-100
AHSKA50-BL41-050-150
AHSKA50-BL41-075-070
AHSKA63-BL41-063-160
AHSKA63-BL41-080-250
AHSKA63-BL41-120-160
AHSKA80-BL41-080-250
AHSKA80-BL41-090-310
AHSKA100-BL41-097-250
AHSKA100-BL41-120-315



AC..

ISO 26623-1 / POLİGONAL ŞAFTLI VELDON ŞAFTLI TAKIM TUTUCULAR
ISO 26623-1 / POLYGONAL SHANK END MILL HOLDER

AC3-EM-06-046	AC5-EM-16-060	AC6-EM-12-100	AC8-EM-10-070
AC3-EM-08-046	AC5-EM-18-060	AC6-EM-14-065	AC8-EM-12-070
AC3-EM-10-050	AC5-EM-20-060	AC6-EM-14-100	AC8-EM-14-070
AC3-EM-12-055	AC5-EM-25-080	AC6-EM-16-065	AC8-EM-16-070
AC4-EM-06-050	AC6-EM-06-055	AC6-EM-16-085	AC8-EM-18-070
AC4-EM-08-050	AC6-EM-06-075	AC6-EM-16-100	AC8-EM-20-070
AC4-EM-10-050	AC6-EM-06-100	AC6-EM-18-065	AC8-EM-25-090
AC4-EM-12-055	AC6-EM-08-055	AC6-EM-18-100	AC8-EM-32-100
AC4-EM-14-055	AC6-EM-08-075	AC6-EM-20-065	AC8-EM-40-110
AC4-EM-16-060	AC6-EM-08-100	AC6-EM-20-100	AC8-EM-50-120
AC5-EM-06-050	AC6-EM-10-060	AC6-EM-25-080	
AC5-EM-08-050	AC6-EM-10-075	AC6-EM-32-090	
AC5-EM-10-055	AC6-EM-10-100	AC6-EM-40-100	
AC5-EM-12-060	AC6-EM-12-065	AC8-EM-06-070	
AC5-EM-14-060	AC6-EM-12-080	AC8-EM-08-070	

ISO 26623-1 / POLİGONAL ŞAFTLI ER SIKMA PENSLİ TAKIM TUTUCULAR
ISO 26623-1 / POLYGONAL SHANK COLLET CHUCKS ER



AC..

AC3-ER-16-045	AC5-ER-32-100	AC6-ER-32-130
AC4-ER-16-070	AC6-ER-16-060	AC6-ER-40-065
AC4-ER-25-055	AC6-ER-16-100	AC6-ER-40-100
AC4-ER-32-055	AC6-ER-16-130	AC6-ER-40-130
AC5-ER-16-055	AC6-ER-25-060	AC8-ER-32-070
AC5-ER-16-100	AC6-ER-25-100	AC8-ER-32-100
AC5-ER-16-130	AC6-ER-25-130	AC8-ER-32-160
AC5-ER-25-055	AC5-ER-32-055	AC8-ER-40-070
AC5-ER-25-100	AC6-ER-32-060	AC8-ER-40-100
AC5-ER-32-055	AC6-ER-32-100	AC8-ER-40-160



AC..

ISO 26623-1 / POLİGONAL ŞAFTLI ER MİNİ SIKMA PENSLİ TAKIM TUTUCULAR
ISO 26623-1 / POLYGONAL SHANK COLLET CHUCKS ER MİNİ

AC4-ER-16-070-M
AC5-ER-16-100-M
AC5-ER-16-130-M
AC6-ER-16-100-M
AC6-ER-16-130-M

Tutucular / Holders

new



İnç Ölçüler/Dimensions in Inches/
Abmessungen in Inch

AC..

ISO 26623-1 / POLİGONAL ŞAFTLI
VELDON ŞAFTLI TAKIM TUTUCULAR
ISO 26623-1 / POLYGONAL SHANK END
MILL HOLDER

AC6-EM-0375-237
AC6-EM-0500-237
AC6-EM-0625-256
AC6-EM-0750-256
AC6-EM-1000-335
AC6-EM-1250-335
AC6-EM-1500-354

new



İnç Ölçüler/Dimensions in Inches/
Abmessungen in Inch

AC..

ISO 26623-1 / POLİGONAL ŞAFTLI ER MİNİ
SIKMA PENSLİ TAKIM TUTUCULAR
ISO 26623-1 / POLYGONAL SHANK COLLET
CHUCKS ER MİNİ

AC6-ER-16-3.0
AC6-ER-32-3.0
AC6-ER-16-6.0
AC6-ER-32-6.0

new



İnç Ölçüler/Dimensions in Inches/
Abmessungen in Inch

AC..

ISO 26623-1 / POLİGONAL ŞAFTLI
YÜZEY FREZE TAKIM TUTUCULAR
ISO 26623-1 / POLYGONAL SHANK
SHELL MILL HOLDER

AC6-FM-0750-118
AC6-FM-0750-480
AC6-FM-0750-756
AC6-FM-1000-118
AC6-FM-1250-157

new



İnç Ölçüler/Dimensions in Inches/
Abmessungen in Inch

AC..

ISO 26623-1 / POLİGONAL ŞAFTLI
DİKDÖRTGEN SAPLI KATER TUTUCULAR
ISO 26623-1 / POLYGONAL SHANK
TOOLHOLDER AXIAL

AC6-ASHR-16-1-H
AC6-ASHL-16-1-H

new



AC..

ISO 26623-1 / POLİGONAL ŞAFTLI
YÜZEY FREZE TAKIM TUTUCULAR
ISO 26623-1 / POLYGON SHANK
SHELL MILL HOLDER

AC3-FM-16-030	AC6-FM-22-050
AC4-FM-16-035	AC6-FM-22-100
AC4-FM-22-040	AC6-FM-27-050
AC5-FM-16-035	AC6-FM-27-100
AC5-FM-16-070	AC6-FM-32-060
AC5-FM-22-040	AC8-FM-27-100
AC5-FM-22-070	AC8-FM-32-100
AC5-FM-27-040	AC8-FM-40-060
AC6-FM-16-035	
AC6-FM-16-100	

ISO 26623-1 / POLİGONAL ŞAFTLI MODÜLER
PARMAK FREZE TUTUCULAR
ISO 26623-1 / POLYGON SHANK MILLING CUTTER
ARBORS FOR SCREW-ON TYPE MILLING CUTTERS

AC3-MM-08-030	AC5-MM-10-050	AC6-MM-12-050
AC3-MM-10-030	AC5-MM-10-075	AC6-MM-12-075
AC3-MM-12-035	AC5-MM-12-050	AC6-MM-16-050
AC3-MM-16-040	AC5-MM-12-075	AC6-MM-16-075
AC4-MM-08-030	AC5-MM-16-050	AC8-MM-08-085
AC4-MM-10-035	AC5-MM-16-075	AC8-MM-10-085
AC4-MM-12-040	AC6-MM-08-050	AC8-MM-12-085
AC4-MM-16-045	AC6-MM-08-075	AC8-MM-16-085
AC5-MM-08-050	AC6-MM-10-050	
AC5-MM-08-075	AC6-MM-10-075	

AC..

new



AC..

ISO 26623-1 / POLİGONAL ŞAFTLI
KOMBİNE YÜZEY FREZE TUTUCULAR
ISO 26623-1 / POLYGON SHANK COMBI
SHELL MILL HOLDER

AC3-FMC-16-045	AC6-FMC-22-055
AC4-FMC-16-045	AC6-FMC-22-100
AC4-FMC-22-050	AC6-FMC-27-055
AC5-FMC-16-045	AC6-FMC-27-100
AC5-FMC-16-070	AC6-FMC-32-055
AC5-FMC-22-045	AC6-FMC-40-060
AC5-FMC-22-070	AC8-FMC-16-060
AC5-FMC-27-055	AC8-FMC-22-060
AC5-FMC-32-055	AC8-FMC-27-065
AC6-FMC-16-050	AC8-FMC-32-065
AC6-FMC-16-100	AC8-FMC-40-070

AC..

ISO 26623-1 / POLİGONAL
ŞAFTLI DİKDÖRTGEN
SAPLIKATER TUTUCULAR
ISO 26623-1 / POLYGON
SHANK TOOLHOLDER AXIAL

AC4-ASHR-16-1-H
AC5-ASHR-20-1-H
AC6-ASHR-20-1-H
AC6-ASHR-25-1-H
AC8-ASHR-32-1-H

new



AC..

ISO 26623-1 / POLİGO-
NAL ŞAFTLI UZATMA
ADAPTÖR TUTUCULAR
ISO 26623-1 / POLYGON
SHANK EXTENSION

AC3-EX-C3-060
AC3-EX-C3-080
AC4-EX-C4-060
AC4-EX-C4-080
AC5-EX-C5-080
AC5-EX-C5-100
AC6-EX-C6-060
AC6-EX-C6-100
AC6-EX-C6-140
AC8-EX-C8-100
AC8-EX-C8-125



AC..

POLYGON SHANK BLANK TUTUCULAR
POLYGON SHANK BLANK HOLDERS

AC3-BL41-032-090	AC5-BL41-050-050	AC6-BL41-080-250
AC3-BL41-032-125	AC5-BL41-050-175	AC8-BL41-080-055
AC3-BL41-060-090	AC5-BL41-075-070	AC8-BL41-120-160
AC4-BL41-040-045	AC6-BL41-063-048	
AC4-BL41-040-165	AC6-BL41-063-100	
AC4-BL41-052-065	AC6-BL41-063-195	
AC4-BL41-070-100	AC6-BL41-063-310	



AC..

ISO 26623-1 / POLİGONAL ŞAFTLI UZATMA
ADAPTÖR TUTUCULAR
ISO 26623-1 / POLYGON SHANK EXTENSION

AC5-RE-C3-060	AC8-RE-C6-055
AC5-RE-C4-065	AC8-RE-C6-080
AC6-RE-C4-080	
AC6-RE-C5-080	
AC8-RE-C3-060	
AC8-RE-C4-070	
AC8-RE-C5-080	

Döner Broş Açma Takımları
Rotary Broach Tool Holder



ABTH..

Döner Broş Açma Takımları
Rotary Broach Tool Holder

ABTH-D08-W25-L125
ABTH-D10-W25-L125
new ABTH-D12-W25-L125

Vidalı Takım Tutucular
Screwed Tool Holders



AVTT..

Vidalı Takım Tutucular
Screwed Tool Holders

AVTT-D13-C16-M08-L100-H
AVTT-D15-C16-M08-L130-H
AVTT-D18-C20-M10-L130-H
AVTT-D18-C20-M10-L160-H
AVTT-D23-C25-M12-L150-H
AVTT-D23-C25-M12-L200-H
AVTT-D23-C25-M12-L250-H
AVTT-D30-C32-M16-L150-H
AVTT-D30-C32-M16-L200-H
AVTT-D30-C32-M16-L250-H
AVTT-D30-C32-M16-L300-H

Düz Uzatma Adaptör Tutucular
Flat Extension Adapter Holder



AC..

ISO 26623-1 / Düz Uzatma
Adaptör Tutucular
ISO 26623-1 / Flat Extension
Adapter Holder

AC5-NC3000-10024-D050

Mini Cut Tutucular / Mini Cut Holders



APCH..

MINİ CUT TUTUCULAR
MINI CUT HOLDERS

APCH-16-4-L110-H	APCH-20-6-L110-H	APCH-22-6-L110-H	APCH-25-6-L110-H
APCH-16-5-L110-H	APCH-20-7-L110-H	APCH-22-7-L110-H	APCH-25-7-L110-H
APCH-16-6-L110-H	APCH-20-8-L110-H	APCH-22-8-L110-H	APCH-25-8-L110-H
APCH-16-7-L110-H	APCH-20-10-L110-H	APCH-22-10-L110-H	APCH-25-10-L110-H
APCH-20-4-L110-H	APCH-22-4-L110-H	APCH-25-4-L110-H	
APCH-20-5-L110-H	APCH-22-5-L110-H	APCH-25-5-L110-H	





ISO 26623-1 / POLİGONAL
SAFTLI YEKPARE TAKIMLAR
ISO 26623-1 / MONOBLOCK
TOOLS WITH POLYGONAL
SHANK



- new AC3 PCLNR/L 22040 12 H
- AC4 PCLNR/L 27050 12 H
- new AC4 PCLNR/L 27050 16 H
- AC5 PCLNR/L 35060 12 H
- new AC5 PCLNR/L 35060 16 H
- new AC5 PCLNR/L 35060 19 H
- new AC6 PCLNR/L 45065 12 H
- new AC6 PCLNR/L 45065 16 H
- new AC6 PCLNR/L 45065 19 H
- AC8 PCLNR/L 55080 12 H
- new AC8 PCLNR/L 55080 16 H
- new AC8 PCLNR/L 55080 19 H
- new AC8 PCLNR/L 55080 25C

95° **PCLNR/L**



ISO 26623-1 / POLİGONAL
SAFTLI YEKPARE TAKIMLAR
ISO 26623-1 / MONOBLOCK
TOOLS WITH POLYGONAL
SHANK



- new AC5 PDJNR/L 35060 11 H
- AC4 PDJNR/L 27060 15 H
- AC5 PDJNR/L 35060 15 H
- AC6 PDJNR/L 45065 15 H
- AC6 PDJNR/L 45165 15 H
- AC8 PDJNR/L 55080 15 H

93° **PDJNR/L**



ISO 26623-1 / POLİGONAL
SAFTLI YEKPARE TAKIMLAR
ISO 26623-1 / MONOBLOCK
TOOLS WITH POLYGONAL
SHANK



- AC6 PRSCR/L 45065 25
- AC8 PRSCR/L 55080 25
- AC8 PRSCR/L 55080 32

- **PRSCR/L**



ISO 26623-1 / POLİGONAL
SAFTLI YEKPARE TAKIMLAR
ISO 26623-1 / MONOBLOCK
TOOLS WITH POLYGONAL
SHANK



- AC4 00050 12 H
- AC5 PSDNN 00060 12 H
- AC6 PSDNN 00065 12 H
- AC4 PSDNN 00050 15 H
- AC5 PSDNN 00060 15 H
- AC6 PSDNN 00065 15 H
- AC5 PSDNN 00060 19 H
- AC6 PSDNN 00065 19 H
- AC6 PSDNN 00065 25C
- AC8 PSDNN 00080 25C

45° **PSDNN**



ISO 26623-1 / POLİGONAL
SAFTLI YEKPARE TAKIMLAR
ISO 26623-1 / MONOBLOCK
TOOLS WITH POLYGONAL
SHANK



- AC4 PSKNR/L 27050 12 H
- AC5 PSKNR/L 35060 12 H
- AC6 PSKNR/L 45065 12 H
- AC5 PSKNR/L 35060 15 H
- AC6 PSKNR/L 45065 15 H
- AC5 PSKNR/L 35060 19 H
- AC6 PSKNR/L 45065 19 H
- AC8 PSKNR/L 55080 19 H
- AC8 PSKNR/L 55080 25C

75° **PSKNR/L**



ISO 26623-1 / POLİGONAL
SAFTLI YEKPARE TAKIMLAR
ISO 26623-1 / MONOBLOCK
TOOLS WITH POLYGONAL
SHANK



- AC3 PSSNR/L 22032 12 H
- AC4 PSSNR/L 27042 12 H
- AC5 PSSNR/L 35052 12 H
- AC6 PSSNR/L 45056 12 H
- AC6 PSSNR/L 45054 15 H
- AC6 PSSNR/L 45052 19 H
- AC8 PSSNR/L 55070 25

45° **PSSNR/L**



ISO 26623-1 / POLİGONAL
SAFTLI YEKPARE TAKIMLAR
ISO 26623-1 / MONOBLOCK
TOOLS WITH POLYGONAL
SHANK



- new AC3 SCLCR/L 22040 09
- new AC4 SCLCR/L 27050 09
- new AC5 SCLCR/L 35060 09
- new AC6 SCLCR/L 45065 09
- new AC3 SCLCR/L 22040 12
- AC4 SCLCR/L 27050 12 H
- AC5 SCLCR/L 35060 12 H
- AC6 SCLCR/L 45065 12 H

95° **SCLCR/L**



ISO 26623-1 / POLİGONAL
SAFTLI YEKPARE TAKIMLAR
ISO 26623-1 / MONOBLOCK
TOOLS WITH POLYGONAL
SHANK



- new AC3 SDJCR/L 22040 07
- new AC4 SDJCR/L 27050 07
- new AC3 SDJCR/L 22040 11
- AC4 SDJCR/L 27050 11 H
- AC5 SDJCR/L 35060 11 H
- AC6 SDJCR/L 45065 11 H

93° **SDJCR/L**



ISO 26623-1 / POLİGONAL
SAFTLI YEKPARE TAKIMLAR
ISO 26623-1 / MONOBLOCK
TOOLS WITH POLYGONAL
SHANK



- AC3 SDNCN 00040 11
- AC4 SDNCN 00050 11
- AC5 SDNCN 00060 11

62.5° **SDNCN**

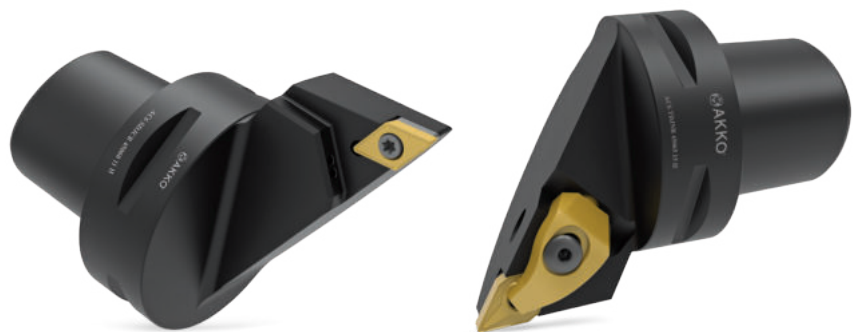



90° **STGCR/L**

ISO 26623-1 / POLİGONAL
ŞAFTLI YEKPAE TAKIMLAR
ISO 26623-1 / MONOBLOCK
TOOLS WITH POLYGONAL
SHANK

AC3 STGCR/L 22040 11
AC4 STGCR/L 27050 11
AC3 STGCR/L 22040 16
AC4 STGCR/L 27050 16
AC5 STGCR/L 35060 16
AC6 STGCR/L 45065 16



93° **SVJBR/L**

ISO 26623-1 / POLİGONAL
ŞAFTLI YEKPAE TAKIMLAR
ISO 26623-1 / MONOBLOCK
TOOLS WITH POLYGONAL
SHANK

AC4 SVJBR/L 27050 16
AC5 SVJBR/L 35060 16
AC6 SVJBR/L 45065 16



93° **SVJCR/L**

ISO 26623-1 / POLİGONAL
ŞAFTLI YEKPAE TAKIMLAR
ISO 26623-1 / MONOBLOCK
TOOLS WITH POLYGONAL
SHANK

AC3 SVJCR/L 22040 11
AC4 SVJCR/L 27050 11
AC4 SVJCR/L 27050 16
AC5 SVJCR/L 35060 11
AC5 SVJCR/L 35060 16
AC6 SVJCR/L 45065 16



72.5° **SVVBN**

ISO 26623-1 / POLİGONAL
ŞAFTLI YEKPAE TAKIMLAR
ISO 26623-1 / MONOBLOCK
TOOLS WITH POLYGONAL
SHANK

AC4 SVVBN 00050 16
AC5 SVVBN 00060 16
AC6 SVVBN 00065 16



72.5° **SVVCN**

ISO 26623-1 / POLİGONAL
ŞAFTLI YEKPAE TAKIMLAR
ISO 26623-1 / MONOBLOCK
TOOLS WITH POLYGONAL
SHANK

AC3 SVVCN 00040 11
AC4 SVVCN 00050 11
AC4 SVVCN 00050 16
AC5 SVVCN 00060 16
AC6 SVVCN 00065 16



107.5° **SVHCR/L**

ISO 26623-1 / POLİGONAL
ŞAFTLI YEKPAE TAKIMLAR
ISO 26623-1 / MONOBLOCK
TOOLS WITH POLYGONAL
SHANK

AC3 SVHCR/L 22040 11
AC4 SVHCR/L 27050 11
AC4 SVHCR/L 27050 16
AC5 SVHCR/L 35060 11
AC5 SVHCR/L 35060 16
AC6 SVHCR/L 45065 16



107.5° **SVHBR/L**

ISO 26623-1 / POLİGONAL
ŞAFTLI YEKPAE TAKIMLAR
ISO 26623-1 / MONOBLOCK
TOOLS WITH POLYGONAL
SHANK

AC4 SVHBR/L 27050 16
AC5 SVHBR/L 35060 16
AC6 SVHBR/L 45065 16



93° **STJCR/L**

ISO 26623-1 / POLİGONAL
ŞAFTLI YEKPAE TAKIMLAR
ISO 26623-1 / MONOBLOCK
TOOLS WITH POLYGONAL
SHANK

AC3 STJCR/L 22040 11
AC3 STJCR/L 22040 16
AC4 STJCR/L 27050 11
AC4 STJCR/L 27050 16
AC5 STJCR/L 35060 16



93° **TCKNR/L**

ISO 26623-1 / POLİGONAL
ŞAFTLI YEKPAE TAKIMLAR
ISO 26623-1 / MONOBLOCK
TOOLS WITH POLYGONAL
SHANK

AC4 TCKNR/L 27050 12 H
AC5 TCKNR/L 35060 12 H
AC6 TCKNR/L 45065 12 H
AC4 TCKNR/L 27050 16 H
AC5 TCKNR/L 35060 16 H
AC6 TCKNR/L 45065 16 H
AC6 TCKNR/L 45065 19 H
AC8 TCKNR/L 55080 19 H



95° **TCLNR/L**

ISO 26623-1 / POLİGONAL
ŞAFTLI YEKPAE TAKIMLAR
ISO 26623-1 / MONOBLOCK
TOOLS WITH POLYGONAL
SHANK

new AC3 TCLNR/L 22040 09 H
new AC4 TCLNR/L 27050 09 H
new AC3 TCLNR/L 22045 12 H
AC4 TCLNR/L 27060 12 H
AC5 TCLNR/L 35060 12 H
AC6 TCLNR/L 45065 12 H
AC8 TCLNR/L 55080 12 H
new AC4 TCLNR/L 27055 16 H
new AC5 TCLNR/L 35060 16 H
new AC6 TCLNR/L 45065 16 H
new AC8 TCLNR/L 55080 16 H
new AC5 TCLNR/L 35060 19 H
new AC6 TCLNR/L 45065 19 H
new AC8 TCLNR/L 55080 19 H



50° **TCMNN**

ISO 26623-1 / POLİGONAL
ŞAFTLI YEKPAE TAKIMLAR
ISO 26623-1 / MONOBLOCK
TOOLS WITH POLYGONAL
SHANK

AC6 TCMNN 00115 12
AC8 TCMNN 00150 16



50° **TDNNN**

ISO 26623-1 / POLİGONAL
ŞAFTLI YEKPAE TAKIMLAR
ISO 26623-1 / MONOBLOCK
TOOLS WITH POLYGONAL
SHANK

AC4 TDNNN 00050 11
AC4 TDNNN 00055 15
AC5 TDNNN 00060 15
AC6 TDNNN 00065 15
AC8 TDNNN 00080 15

Poligonal Şaftlı Yekpare Takımlar / Monoblock Tools With Polygonal Shank

 <p>93° TDHNR/L</p>	<p>ISO 26623-1 / POLİGONAL ŞAFTLI YEKPARE TAKIMLAR ISO 26623-1 / MONOBLOCK TOOLS WITH POLYGONAL SHANK</p> <p>AC4 TDHNR/L 27055 15 H AC5 TDHNR/L 35060 15 H AC6 TDHNR/L 45065 15 H AC8 TDHNR/L 55080 15 H</p>	 <p>93° TDJNR/L</p>	<p>ISO 26623-1 / POLİGONAL ŞAFTLI YEKPARE TAKIMLAR ISO 26623-1 / MONOBLOCK TOOLS WITH POLYGONAL SHANK</p> <p>AC3 TDJNR/L 22045 11 AC4 TDJNR/L 27050 11 H AC5 TDJNR/L 35060 11 H AC6 TDJNR/L 45065 11 H AC4 TDJNR/L 27060 15 H AC5 TDJNR/L 35060 15 H AC6 TDJNR/L 45065 15 H AC8 TDJNR/L 55080 15 H</p>	 <p>50° TSDNN</p>	<p>ISO 26623-1 / POLİGONAL ŞAFTLI YEKPARE TAKIMLAR ISO 26623-1 / MONOBLOCK TOOLS WITH POLYGONAL SHANK</p> <p>AC3 TSDNN 00048 12 AC4 TSDNN 00050 12 AC5 TSDNN 00060 12 AC6 TSDNN 00065 12 AC5 TSDNN 00060 15 AC6 TSDNN 00065 15 AC5 TSDNN 00065 19 AC6 TSDNN 00070 19</p>
 <p>75° TSKNR/L</p>	<p>ISO 26623-1 / POLİGONAL ŞAFTLI YEKPARE TAKIMLAR ISO 26623-1 / MONOBLOCK TOOLS WITH POLYGONAL SHANK</p> <p>AC3 TSKNR/L 22040 12 AC4 TSKNR/L 27050 12 H AC5 TSKNR/L 35060 12 H AC6 TSKNR/L 45065 12 H AC5 TSKNR/L 35060 15 H AC6 TSKNR/L 45065 15 H AC5 TSKNR/L 35060 19 H AC6 TSKNR/L 45065 19 H AC8 TSKNR/L 55080 19 H</p>	 <p>45° TSSNR/L</p>	<p>ISO 26623-1 / POLİGONAL ŞAFTLI YEKPARE TAKIMLAR ISO 26623-1 / MONOBLOCK TOOLS WITH POLYGONAL SHANK</p> <p>AC3 TSSNR/L 22040 12 AC4 TSSNR/L 27042 12 AC5 TSSNR/L 35052 12 H AC6 TSSNR/L 45056 12 H AC4 TSSNR/L 27045 15 AC5 TSSNR/L 35050 15 H AC6 TSSNR/L 45054 15 H AC5 TSSNR/L 35048 19 H AC6 TSSNR/L 45052 19 H</p>	 <p>90° TTGNR/L</p>	<p>ISO 26623-1 / POLİGONAL ŞAFTLI YEKPARE TAKIMLAR ISO 26623-1 / MONOBLOCK TOOLS WITH POLYGONAL SHANK</p> <p>AC4 TTGNR/L 27050 22 H AC5 TTGNR/L 35060 22 H AC6 TTGNR/L 45065 16 H AC6 TTGNR/L 45065 22 H</p>
 <p>93° TTJNR/L</p>	<p>ISO 26623-1 / POLİGONAL ŞAFTLI YEKPARE TAKIMLAR ISO 26623-1 / MONOBLOCK TOOLS WITH POLYGONAL SHANK</p> <p>AC5 TTJNR/L 35060 16 H</p>	 <p>93° TVJNR/L</p>	<p>ISO 26623-1 / POLİGONAL ŞAFTLI YEKPARE TAKIMLAR ISO 26623-1 / MONOBLOCK TOOLS WITH POLYGONAL SHANK</p> <p>AC4 TVJNR/L 27062 16 H AC5 TVJNR/L 35065 16 H AC6 TVJNR/L 45065 16 H AC8 TVJNR/L 55080 16 H</p>	 <p>50° TVVNN</p>	<p>ISO 26623-1 / POLİGONAL ŞAFTLI YEKPARE TAKIMLAR ISO 26623-1 / MONOBLOCK TOOLS WITH POLYGONAL SHANK</p> <p>AC4 TVVNN 00062 16 AC5 TVVNN 00065 16 AC6 TVVNN 00065 16 AC8 TVVNN 00080 16</p>
 <p>95° TWLNR/L</p>	<p>ISO 26623-1 / POLİGONAL ŞAFTLI YEKPARE TAKIMLAR ISO 26623-1 / MONOBLOCK TOOLS WITH POLYGONAL SHANK</p> <p>AC3 TWLNR/L 22040 06 H AC4 TWLNR/L 27050 06 H AC5 TWLNR/L 35060 06 H AC6 TWLNR/L 45065 06 H AC4 TWLNR/L 27060 08 H AC5 TWLNR/L 35060 08 H AC6 TWLNR/L 45065 08 H AC8 TWLNR/L 55080 08 H</p>				



ISO 26623-1 / POLİGONAL ŞAFTLI YEKPARE TAKIMLAR
ISO 26623-1 / MONOBLOCK TOOLS WITH POLYGONAL SHANK

- | | |
|-----------------------------------|------------------------------------|
| AC4 PCLNR/L 13080 09 H | AC5 PCLNR/L 22110 12 HC |
| AC5 PCLNR/L 13080 09 H | AC5 PCLNR/L 27140 12 HC |
| AC3 PCLNR/L 17090 12 HC | AC5 PCLNR/L 35100 12 HC |
| AC3 PCLNR/L 22064 12 HC | AC6 PCLNR/L 17100 12 HC |
| new AC3 PCLNR/L 22096 12 H | AC6 PCLNR/L 22110 12 HC |
| AC4 PCLNR/L 17090 12 HC | AC5 PCLNR/L 35150 16 HC |
| AC4 PCLNR/L 22110 12 HC | new AC6 PCLNR/L 35175 16 HC |
| AC4 PCLNR/L 27080 12 HC | AC6 PCLNR/L 27140 16 HC |
| AC4 PCLNR/L 27120 12 HC | AC6 PCLNR/L 35175 16 HC |
| AC5 PCLNR/L 17090 12 HC | |

95° **PCLNR/L**



ISO 26623-1 / POLİGONAL ŞAFTLI YEKPARE TAKIMLAR
ISO 26623-1 / MONOBLOCK TOOLS WITH POLYGONAL SHANK

- | | |
|-----------------------------------|-----------------------------------|
| new AC3 SDUCR/L 11065 07 H | AC4 SDUCR/L 17090 11 H |
| new AC4 SDUCR/L 11070 07 H | new AC4 SDUCR/L 22110 11 H |
| new AC5 SDUCR/L 11070 07 H | new AC4 SDUCR/L 27080 11 H |
| new AC3 SDUCR/L 13075 11 H | AC5 SDUCR/L 13080 11 H |
| new AC3 SDUCR/L 17090 11 H | AC5 SDUCR/L 17090 11 H |
| new AC3 SDUCR/L 22064 11 H | new AC5 SDUCR/L 35100 11 H |
| new AC3 SDUCR/L 22096 11 H | |
| AC4 SDUCR/L 13080 11 H | |

93° **SDUCR/L**



ISO 26623-1 / POLİGONAL ŞAFTLI YEKPARE TAKIMLAR
ISO 26623-1 / MONOBLOCK TOOLS WITH POLYGONAL SHANK

- | | |
|-------------------------|-------------------------|
| AC3 STFRCR/L 11065 11 H | AC4 STFRCR/L 22110 16 H |
| AC3 STFRCR/L 13075 11 H | AC5 STFRCR/L 11070 11 H |
| AC3 STFRCR/L 17090 16 H | AC5 STFRCR/L 13080 11 H |
| AC4 STFRCR/L 11070 11 H | AC5 STFRCR/L 17090 16 H |
| AC4 STFRCR/L 13080 11 H | AC5 STFRCR/L 22110 16 H |
| AC4 STFRCR/L 17090 16 H | |

90° **STFRCR/L**



ISO 26623-1 / POLİGONAL ŞAFTLI YEKPARE TAKIMLAR
ISO 26623-1 / MONOBLOCK TOOLS WITH POLYGONAL SHANK

- | |
|------------------------|
| AC4 TCLNR/L 13080 09 H |
| AC5 TCLNR/L 13080 09 H |
| AC4 TCLNR/L 17090 12 H |
| AC5 TCLNR/L 17090 12 H |
| AC6 TCLNR/L 17100 12 H |

95° **TCLNR/L**



ISO 26623-1 / POLİGONAL ŞAFTLI YEKPARE TAKIMLAR
ISO 26623-1 / MONOBLOCK TOOLS WITH POLYGONAL SHANK

- | |
|----------------------|
| AC3 TER/L 22040 16 |
| AC3 TER/L 22040 22 |
| AC4 TER/L 27050 16 H |
| AC4 TER/L 27050 22 |
| AC5 TER/L 35060 16 H |
| AC5 TER/L 35060 22 |
| AC6 TER/L 45065 16 H |
| AC6 TER/L 45065 22 |
| AC8 TER/L 55080 22 |

- **TER/L**



ISO 26623-1 / POLİGONAL ŞAFTLI YEKPARE TAKIMLAR
ISO 26623-1 / MONOBLOCK TOOLS WITH POLYGONAL SHANK

- | |
|----------------------|
| AC3 SIR/L 12050 16 H |
| AC4 SIR/L 12060 16 H |
| AC4 SIR/L 15065 22 H |
| AC5 SIR/L 12060 16 H |
| AC5 SIR/L 15065 22 H |

- **SIR/L**



ISO 26623-1 / POLİGONAL ŞAFTLI YEKPARE TAKIMLAR
ISO 26623-1 / MONOBLOCK TOOLS WITH POLYGONAL SHANK

- | | |
|---------------------------------|---------------------------------|
| new AC3 TIR/L 14060 16 H | AC5 TIR/L 22090 16 H |
| new AC3 TIR/L 22085 16 H | new AC5 TIR/L 22090 22 H |
| AC4 TIR/L 14060 16 H | AC5 TIR/L 27105 16 H |
| AC4 TIR/L 17070 16 H | new AC5 TIR/L 27105 22 H |
| new AC4 TIR/L 19070 22 H | new AC6 TIR/L 14070 16 H |
| AC4 TIR/L 22090 16 H | AC6 TIR/L 17075 16 H |
| new AC4 TIR/L 22090 22 H | new AC6 TIR/L 19075 22 H |
| new AC4 TIR/L 27080 16 H | AC6 TIR/L 22090 16 H |
| new AC4 TIR/L 27080 22 H | new AC6 TIR/L 22090 22 H |
| new AC5 TIR/L 14060 16 H | AC6 TIR/L 27105 16 H |
| AC5 TIR/L 17070 16 H | new AC6 TIR/L 27105 22 H |
| new AC5 TIR/L 19070 22 H | |

- **TIR/L**

Diş Çap Tornalama Katerleri / External Turning Toolholders

 <p>T Sistem/T System 2525 M16</p> <p>75° TCBNR / L</p>	 <p>T Sistem/T System 2020 K12 2525 M12 3232 P12 2525 M16 3232 P16</p> <p>75° TCKNR / L</p>	 <p>T Sistem/T System 2020 K12 2525 M12 3232 P12 4040 S12 5050 S12 2525 M16 3232 P16</p> <p>95° TCLNR / L</p>	
 <p>T Sistem/T System 1616 H12 2020 K12 2525 M12 3232 P12 2525 M16 3232 P16 4040 S16</p> <p>50° TCMNN</p>	 <p>T Sistem/T System 2020 K12 2525 M12 3232 P12 2525 M16 3232 P16</p> <p>40° TCZNN</p>	 <p>T Sistem/T System 2525 M11 2020 K15 2525 M15 3232 P15</p> <p>107.5° TDHNR / L</p>	
 <p>T Sistem/T System 1616 H11 2020 K11 2525 M11 3232 P15 4040 S15 5050 S15</p> <p>93° TDJNR / L</p>	 <p>T Sistem/T System 1616 H11 2020 K11 2525 M11 2020 K15 2525 M15 3232 P15 4040 S15 5050 S15</p> <p>62.5° TDNNS</p>	 <p>T Sistem/T System 1616 H12 2020 K12 2525 M12 3232 P12 2525 M15 3232 P15 4040 S15</p> <p>45° TSDNN</p>	
 <p>T Sistem/T System 2020 K12 2525 M12 3232 P12 3232 P15</p> <p>75° TSKNR / L</p>	 <p>T Sistem/T System 2020 K12 2525 M12 3232 P12 2525 M15 3232 P15</p> <p>45° TSSNR / L</p>	 <p>T Sistem/T System 2020 K16 2525 M16 3232 P16 2525 M22 3232 P22 4040 S22</p> <p>60° TTENN</p>	 <p>T Sistem/T System 2020 K16 2525 M16 3232 P16 2525 M22 3232 P22 4040 S22</p> <p>90° TTGNR / L</p>
 <p>T Sistem/T System 2020 K16 2525 M16 3232 P16 2525 M22 3232 P22 4040 S22</p> <p>93° TTJNR / L</p>	 <p>T Sistem/T System 2020 K16 2525 M16 3232 P16</p> <p>107.5° TVHNR / L</p>	 <p>T Sistem/T System 2020 K16 2525 M16 3232 P16</p> <p>93° TVJNR / L</p>	 <p>T Sistem/T System 2020 K16 2525 M16 3232 P16</p> <p>72.5° TVVNN</p>
 <p>T Sistem/T System 1616 H06 2020 K06 2525 M06 2020 K08 2525 M08 3232 P08 4040 S08</p> <p>95° TWLNR / L</p>	 <p>T Sistem/T System 2020 K12-H 2525 M12-H 3232 P12-H</p> <p>75° TCBNR / L</p>	 <p>T Sistem/T System 2020 K12-H 2525 M12-H 3232 P12-H</p> <p>75° TCKNR / L</p>	 <p>T Sistem/T System 2020 K12-H 2525 M12-H 3232 P12-H 3232 P19-H 2525 M16-H 2525 M19-H</p> <p>95° TCLNR / L <small>NEW</small></p>

 <p>93° TDJNR / L</p>	<p>T Sistem/T System</p> <p>2020 K15-H 2525 M11-H 2525 M15-H 3232 P15-H</p>	 <p>62.5° TDNNN</p>	<p>T Sistem/T System</p> <p>2525 M15-H 3232 P15-H</p>	 <p>75° TSBNR / L</p>	<p>T Sistem/T System</p> <p>TSBNR/L 2525 M12-H TSBNR/L 2525 M15-H TSBNR/L 3232 P12-H TSBNR/L 3232 P15-H</p>
 <p>45° TSDNN</p>	<p>T Sistem/T System</p> <p>2525 M12-H 3232 P12-H 2525 M15-H 3232 P15-H 4040 S15-H</p>	 <p>45° TSSNR / L</p>	<p>T Sistem/T System</p> <p>2525 M12-H 3232 P12-H 2525 M15-H 3232 P15-H 4040 S15-H</p>	 <p>93° TTJNR / L</p>	<p>T Sistem/T System</p> <p>2525 M16-H 3232 P16-H 2525 M22-H 3232 P22-H</p>
 <p>93° TVJNR / L</p>	<p>T Sistem/T System</p> <p>2020 K16-H 2525 M16-H 3232 P16-H</p>	 <p>72.5° TVVNN</p>	<p>T Sistem/T System</p> <p>2020 K16-H 2525 M16-H</p>	 <p>95° TWLNR/L</p>	<p>T Sistem/T System</p> <p>2020 K06-H 2525 M06-H 3232 P06-H 2020 K08-H 2525 M08-H 3232 P08-H</p>
 <p>60° MTENN</p>	<p>M Sistem/M System</p> <p>2020 K16 2525 M16 3232 P16 2525 M22 3232 P22 4040 S22</p>	 <p>93° MTJNR / L</p>	<p>M Sistem/M System</p> <p>2020 K16 2525 M16 3232 P16</p> <p>2525 M22 3232 P22 4040 S22</p>	 <p>95° MWLNR / L</p>	<p>M Sistem/M System</p> <p>1616 H06 2020 K06 2525 M06</p> <p>2020 K08 2525 M08 3232 P08</p>
 <p>50° MWMNN</p>	<p>M Sistem/M System</p> <p>1616 H06 2020 K06 2525 M06 2020 K08 2525 M08 3232 P08</p>	 <p>75° PCBNR / L</p>	<p>P Sistem/P System</p> <p>2020 K12C 2525 M12C 3232 P12C 2525 M16C 3232 P16C 2525 P19C 3232 P19C 4040 S19C 4040 S25C 5050 S25C</p>	 <p>95° PCLNR / L</p>	<p>P Sistem/P System</p> <p>1616 H09 2020 K09 2525 M09 1616 H12 2020 K12C 2525 M12C 3232 P12C 2525 M16C</p> <p>3232 P16C 2525 M19C 3232 P19C 4040 S19C 5050 S19C 4040 S25C 5050 S25C</p>
 <p>50° PCMNN</p>	<p>P Sistem/P System</p> <p>2020 K12C 2525 M12C 3232 P12C 2525 M16C 3232 P16C 3232 P19C 4040 S19C 5050 S19C 4040 S25C</p>	 <p>93° PDJNR / L</p>	<p>P Sistem/P System</p> <p>1616 H11 2020 K11 2525 M11 2020 K15C 2525 M15C 3232 P15C 4040 S15C</p>	 <p>62.5° PDNNN</p>	<p>P Sistem/P System</p> <p>1616 H11 2020 K11 2525 M11 2020 K15C 2525 M15C 3232 P15C</p>

Diş Çap Tornalama Katerleri / External Turning Toolholders

 <p>P Sistem/P System 4040 R25 5050 T32</p> <p>45° PRDCN</p>	 <p>P Sistem/P System 1616 H09 3232 P19C 2020 K09 4040 S19C 2020 K12C 5050 S19C 2525 M12C 4040 S25C 3232 P12C 5050 S25C 2525 M15 5050 S2507C 3232 P15C</p> <p>75° PSBNR / L</p>	 <p>P Sistem/P System 1616 H09 3232 P19C 2020 K12C 4040 S19C 2525 M12C 5050 S19C 3232 P12C 4040 S25C 2020 K15 5050 S25C 2525 M15C</p> <p>45° PSDNN</p>
 <p>P Sistem/P System 2020 K09 3232 P19C 2020 K12C 4040 S19C 2525 M12C 4040 S25C 3232 P12C 5050 S25C 2525 M15C 3232 P15C</p> <p>75° PSKNR / L</p>	 <p>P Sistem/P System 1616 H09 3232 P12C 2020 K09 3232 P15C 2020 K12C 3232 P19C 2525 M12C 4040 S19C 4040 S25C</p> <p>45° PSSNR / L</p>	
 <p>P Sistem/P System 1616 H16 2525 2020 K16 M22C 2525 M16 3232 P22C 3232 P16 4040 S27C</p> <p>90° PTFNR / L</p>	 <p>P Sistem/P System 1010 E11 2525 M22C 1212 F11 3232 P22C 1616 H11 4040 S27C 1616 H16 2020 K16 2525 M16 3232 P16</p> <p>90° PTGNR / L</p>	 <p>P Sistem/P System 1010 E11 1212 F11 1616 H11 1616 H16 2020 K16 2525 M16 3232 P16 2525 M22C 3232 P22C 4040 S27C</p> <p>93° PTJNR / L</p>
 <p>P Sistem/P System 1616 H16 2020 K16 2525 M16 3232 P16 2525 M22C 3232 P22C</p> <p>60° PTTNR / L</p>	 <p>P Sistem/P System 1616 H06 2020 K06 2525 M06 1616 H08 2020 K08C 2525 M08C 3232 P08C 3232 P06</p> <p>95° PWLNR / L</p>	 <p>P Sistem/P System 1010 K11-S 1212 K11-S 1616 K11-S</p> <p>93° PDJCR/L</p>
<p>P-Sistem İçten Soğutma Kanallı Diş Torna Katerleri / P-System External Turning Toolholders With Coolant Hole</p>		
 <p>P Sistem/P System 2020 K12-H 2525 M12-H 3232 P12-H 3232 P16-H 3232 P19-H</p> <p>95° PCLNR/L</p>	 <p>P Sistem/P System 2020 K15-H 2525 M15-H 3232 P15-H</p> <p>93° PDJNR/L</p>	 <p>P Sistem/P System 2525 M15-H</p> <p>93° PDNNN</p>
 <p>P Sistem/P System 2020 K08-H 2525 M08-H</p> <p>95° PWLNR/L</p>	 <p>C Sistem/C System 2020 K16 2525 M16 3232 P16 4040 S16</p> <p>93° CKJNR / L</p>	 <p>C Sistem Seramik C System Ceramic 2525 M1207C 3232 P1207C 2525 M1607C 2525 M1207TP 3232 P1207TP 2525 M1607TP 2525 M1207N 3232 P1207N 2525 M1607N</p> <p>95° CCLNR / L</p>

 <p>C Sistem Seramik C System Ceramic</p> <p>2525 M1107C 2525 M1507C 3232 P1507C 2525 M1507TP 3232 P1507TP 2525 M1507N 3232 P1507N</p> <p>93° CDJNR / L</p>	 <p>C Sistem Seramik C System Ceramic</p> <p>2525 M1107C</p> <p>62.5° CDNND</p>	 <p>C Sistem Seramik C System Ceramic</p> <p>2020 K06CV 2525 M06CV 3225 P06CV 4040 S06CV 2020 K09CV 2525 M09CV 3225 P09CV</p> <p>-° CRDCN</p>	<p>C Sistem Seramik C System Ceramic</p> <p>4040 S09CV 2525 M12CV 3225 P12CV 4040 S12CV</p>
 <p>C Sistem Seramik C System Ceramic</p> <p>3232 P06CVK 4040 R06CVK 3232 P09CVK 4040 R09CVK 3232 P12CVK 4040 R12CVK</p> <p>93° CRDCN</p>	 <p>C Sistem Seramik C System Ceramic</p> <p>3225 P06CV 3225 P09CV 3225 P12CV</p> <p>-° CRDCR / L</p>	 <p>new</p> <p>C Sistem Seramik C System Ceramic</p> <p>3232 P0604CVK 3232 P09CVK 3232 P12CVK</p> <p>-° CRDPR/L</p>	<p>C Sistem Seramik C System Ceramic</p>
 <p>C Sistem Seramik C System Ceramic</p> <p>2525 M1207C 3232 P1207C 2525 M1207TP 3232 P1207TP 2525 M1207N 3232 P1207N</p> <p>45° CSDNN</p>	 <p>C Sistem Seramik C System Ceramic</p> <p>2525 M1207C 3232 P1207C 2525 M1207TP 3232 P1207TP 2525 M1207N 3232 P1207N</p> <p>75° CSKNR / L</p>	 <p>C Sistem Seramik C System Ceramic</p> <p>2525 M1207C 3232 P1207C 2525 M1207TP 3232 P1207TP 2525 M1207N 3232 P1207N</p> <p>75° CSRNR / L</p>	<p>C Sistem Seramik C System Ceramic</p>
 <p>C Sistem Seramik C System Ceramic</p> <p>2525 M1207C 3232 P1207C 2525 M1207TP 3232 P1207TP 2525 M1207N 3232 P1207N</p> <p>45° CSSNR / L</p>	 <p>C Sistem Seramik C System Ceramic</p> <p>2525 M1607C 3232 P1607C</p> <p>93° CTJNR / L</p>	 <p>S Sistem/S System</p> <p>0808 E06 1010 E06 1212 F09 1616 H09 2020 K09 2020 K12 2525 M12</p> <p>90° SCACR / L</p>	<p>S Sistem/S System</p>
 <p>S Sistem/S System</p> <p>0808 E06 1010 E06 1212 F06 1010 E09 1212 F09 1212 M09</p> <p>1616 H09 2020 K09 2525 M09 1616 H12 2020 K12 2525 M12</p> <p>95° SCLCR / L</p>	 <p>S Sistem İsviçre Tipi / S System Swiss Type with internal coolant hole</p> <p>1212 K09-SHC 1616 K09-SHC</p> <p>95° SCLCR / L</p>	 <p>S Sistem/S System</p> <p>0808 E06 1010 E06 1212 F06 1212 F09 1616 H09 2020 K12 2525 M12</p> <p>50° SCMCN</p>	<p>S Sistem/S System</p>
 <p>S Sistem/S System</p> <p>0808 E07 1010 E07 1212 F07 1616 H07 1616 H11 2020 K11</p> <p>2525 M 11 3232 P11</p> <p>107.5° SDHCR / L</p>	 <p>S Sistem/S System</p> <p>0808 E07 1010 E07 1212 F07 1616 H07 1212 F11 1616 H11 2020 K11 2525 M 11 3232 P11</p> <p>93° SDJCR / L</p>	 <p>S Sistem İsviçre Tipi / S System Swiss Type with internal coolant hole</p> <p>0810 G07-SHC 1010 K07-SHC 1012 K11-SHC 1212 K11-SHC 1616 K11-SHC</p> <p>93° SDJCR / L</p>	<p>S Sistem İsviçre Tipi / S System Swiss Type with internal coolant hole</p>

Dış Çap Tornalama Katerleri / External Turning Toolholders

 <p>S Sistem/S System</p> <p>0808 E07 1010 E07 1212 F07 1616 H07 1616 H11 2020 K11 2525 M 11 3232 P11</p> <p>62.5° SDNCN</p>	 <p>S Sistem/S System</p> <p>1616 H06 2020 K06 2525 M06 1616 H08C 2020 K08C 2525 M08C</p> <p>1616 H10C 2020 K10C 2525 M10C 3232 P10C 2020 K12C 2525 M12C 3232 P12C</p> <p>2525 M16C 3232 P16C 2525 M20C 3232 P20C 3232 P25C 3232 P32C</p> <p>-° SRDCN</p>	 <p>S Sistem/S System</p> <p>SRDCR/L 3232 T06 new SRDCR/L 2020 M08 new SRDCR/L 2525 M08 SRDCR/L 3232 P12C SRDCR/L 3232 P16C</p> <p>-° SRDCR / L</p>	
 <p>S Sistem/S System</p> <p>1616 H06 2020 K06 1616 H08C 2020 K08C 2525 M08C</p> <p>1616 H10C 2020 K10C 2525 M10C 3232 P10C</p> <p>2020 K12C 2525 M12C 3232 P12C</p> <p>-° SRGCR / L</p>	 <p>S Sistem/S System</p> <p>2525 K06 2525 K08 2525 K10 2525 K12 2525 K16</p> <p>20° SRHCR / L</p>	 <p>S Sistem/S System</p> <p>3232 X08C 3232 X10C 3232 X12C</p> <p>-° SRXCR / L</p>	
 <p>S Sistem/S System</p> <p>1212 F09 1616 H09 2020 K09 1616 H12 2020 K12 2525 M12</p> <p>45° SSDCN</p>	 <p>new</p> <p>S Sistem/S System</p> <p>1212 F09 1616 H09 2020 K09</p> <p>90° SSFCR / L</p>	 <p>S Sistem/S System</p> <p>1212 F09 1616 H09 2020 K09 1616 H12 2020 K12 2525 M12</p> <p>45° SSSCR / L</p>	 <p>S Sistem/S System</p> <p>0808 E09 1010 E09 1212 F11 1616 H11 1616 H16 2020 K16 2525 M16 3232 P16</p> <p>90° STFCR / L</p>
 <p>S Sistem/S System</p> <p>0808 E09 1010 E09 1212 F11 1616 H11 1616 H16 2020 K16 2525 M16 3232 P16</p> <p>90° STGCR / L</p>	 <p>S Sistem/S System</p> <p>0808 E09 1010 E09 1212 F11 1616 H11 1616 H16 2020 K16 2525 M16 3232 P16</p> <p>93° STJCR / L</p>	 <p>S Sistem/S System</p> <p>2020 L11 1616 K16 2020 M16 2525 P16 3232 R16 2525 P22</p> <p>90° STCCN</p>	
 <p>S Sistem/S System</p> <p>0808 E09 1010 E09 1212 F11 1616 H11 1616 H16 2020 K16 2525 M16 3232 P16</p> <p>93° STUCR / L</p>	 <p>S Sistem/S System</p> <p>1212 K11 1616 K11 2020 K11</p> <p>-° SVACR / L</p>	 <p>S Sistem/S System</p> <p>1212 F11 1616 H11 2020 K11 2020 K16 2525 M16 3232 P16</p> <p>107.5° SVHBR / L</p>	
 <p>S Sistem/S System</p> <p>1212 F11 1616 H11 2020 K11 2020 K16 2525 M16 3232 P16</p> <p>107.5° SVHCR / L</p>	 <p>S Sistem/S System</p> <p>1212 F11 1616 H11 2020 K11 1616 H16 2020 K16 2525 M16 3232 P16</p> <p>93° SVJBR / L</p>	 <p>S Sistem/S System</p> <p>1212 F11 1616 H11 2020 K11 2525 M11 1212 F16 2020 K16 2525 M16 3232 P16</p> <p>93° SVJCR / L</p>	



S Sistem İsviçre Tipi / S System Swiss Type with internal coolant hole

1212 K11-SHC
1616 K11-SHC

93° **SVJCR / L**



S Sistem/S System

1212 F11
1616 H11
2020 K11
2020 K16
2525 M16
3232 P16

72.5° **SVVBN**



S Sistem/S System

1212 F11
1616 H11
2020 K11
2020 K16
2525 M16
3232 P16

72.5° **SVVCN**



S Sistem İsviçre Tipi / S System Swiss Type

0808 X06-S 1212 K09-S
1010 K06-S 1616 F09-S
1212 G06-S 1616 K09-S
1212 K06-S 2020 K09-S
1616 F06-S
1616 K06-S
1212 G09-S

90° **SCACR / L**



S Sistem İsviçre Tipi / S System Swiss Type

0808 X06-S 1212 G09-S
1010 X06-S 1212 X09-S
1212 G06-S 1616 F09-S
1212 X06-S 1616 G09-S
1212 K06-S 1616 X09-S
1616 F06-S 2020 X09-S
1616 X06-S

95° **SCLCR / L**



S Sistem İsviçre Tipi / S System Swiss Type

0808 X07-S 1212 K11-S
1010 K07-S 1616 F11-S
1212 G07-S 1616 K11-S
1212 K07-S 2020 K11-S
1616 F07-S
1616 K07-S
1212 G11-S

90° **SDACR / L**



S Sistem İsviçre Tipi / S System Swiss Type

0808 X07-S 1212 G11-S
1010 X07-S 1212 X11-S
1212 G07-S 1212 K11-S
1212 X07-S 1616 F11-S
1616 F07-S 1616 X11-S
1616 X07-S 1616 K11-S
2020 X07-S 2020 X11-S

93° **SDJCR / L**



S Sistem İsviçre Tipi / S System Swiss Type

1216 K11-S
1616 K11-S
1216 K16-S
1616 K16-S

91° **STGCR / L**



S Sistem İsviçre Tipi / S System Swiss Type with internal coolant hole

STGCR/L 1216 K16-SHC
STGCR/L 1616 K16-SHC

90° **STGCR / L**



S Sistem İsviçre Tipi / S System Swiss Type

1616 K11-S

93° **SVJBR / L**



S Sistem İsviçre Tipi / S System Swiss Type

0808 X11-S 2020 K11-S
1010 K11-S 1212 K16-S
1212 G11-S 1616 K16-S
1212 K11-S
1616 F11-S
1616 K11-S

90° **SVACR / L**



S Sistem İsviçre Tipi / S System Swiss Type

0808 X11-S
1010 K11-S
1212 G11-S
1212 K11-S
1616 F11-S
1616 K11-S
2020 K11-S
1616 K16-S
2020 K16-S

93° **SVJCR / L**



SEC Tools

1212-L84-H
1616-L90-H

- **ASTB**



SEC Tools

12X43.3-06-H
16X43.3-06-H
12X43.3-09-H
16X43.3-09-H

- **SCLCR / L**



SEC Tools

12X43.3-07
12X43.3-07-H
16X43.3-07
16X43.3-07-H
12X43.3-11
12X43.3-11-H
16X43.3-11
16X43.3-11-H

93° **SDJCR / L**



SEC Tools

12-43.3-11
12-43.3-11-H
16-43.3-11
16-43.3-11-H

93° **SVJCR / L**



SEC Tools

12x43.3-11
16x43.3-11
16x43.3-16

- **SER/L-**



DETAYLI BİLGİ İÇİN BARKODU OKUTUNUZ
SCAN ME FOR MORE DETAILS



Delik İçi Tornalama Katerleri / Boring Bars



T Sistem/T System

NEW S50V TCKNR/L 16
A32T TCKNR/L 16
A40U TCKNR/L 16

75° **TCKNR / L**



T Sistem/T System

S25S TCLNR/L 09
S25S TCLNR/L 12
S32T TCLNR/L 12
S40U TCLNR/L 12
S50V TCLNR/L 12

95° **TCLNR / L**

T Sistem/T System

S32T TCLNR/L 16
S40U TCLNR/L 16
S50V TCLNR/L 16
A25R TCLNR/L 12
A40T TCLNR/L 12
A50V TCLNR/L 12



T Sistem/T System

S32T TD-NR/L 15
S40U TD-NR/L 15
S50V TD-NR/L 15

62.5° **TD-NR / L**



T Sistem/T System

S25S TDQNR/L 11
S32T TDQNR/L 11
S25S TDQNR/L 15
S32T TDQNR/L 15
S40U TDQNR/L 15
S50V TDQNR/L 15

107.5° **TDQNR / L**



T Sistem/T System

S25S TDUNR/L 11
S32T TDUNR/L 11
S25S TDUNR/L 15
S32T TDUNR/L 15
S40U TDUNR/L 15
S50V TDUNR/L 15
A40T TDUNR/L 15

93° **TDUNR / L**



T Sistem/T System

S25S TSKNR/L 12
S32T TSKNR/L 12
S40U TSKNR/L 12

75° **TSKNR / L**



T Sistem/T System

S25S TT-NR/L 16
S32T TT-NR/L 16
NEW S40U TT-NR/L 16

60° **TT-NR / L**



T Sistem/T System

S25S TTUNR/L 16
S32T TTUNR/L 16
S25S TTUNR/L 22
S32T TTUNR/L 22
S40U TTUNR/L 22
S50V TTUNR/L 22

93° **TTUNR / L**



T Sistem/T System

S25S TVUNR/L 16
S32T TVUNR/L 16
S40U TVUNR/L 16

93° **TVUNR / L**



T Sistem/T System

S25S TWLNR/L 06
S32T TWLNR/L 06
S25S TWLNR/L 08
S32T TWLNR/L 08
S40U TWLNR/L 08
S50V TWLNR/L 08

95° **TWLNR / L**

T Sistem/T System

A32S TWLNR/L 08
A40T TWLNR/L 08
A50U TWLNR/L 08



C Sistem/C System

S25S CKUNR/L 16
S32T CKUNR/L 16
S40U CKUNR/L 16
S50V CKUNR/L 16

93° **CKUNR / L**



C Sistem/C System

S20S CTFPR/L 16
S25T CTFPR/L 16

-° **CTFPR / L**



M Sistem/M System

S20R MCLNR/L 12
S25S MCLNR/L 12
S32T MCLNR/L 12

95° **MCLNR / L**



M Sistem/M System

S20R MDUNR/L 11
S25S MDUNR/L 11
S32T MDUNR/L 11
S25S MDUNR/L 15
S32T MDUNR/L 15
S40U MDUNR/L 15
S50V MDUNR/L 15

93° **MDUNR / L**



M Sistem/M System

S20R MTFNR/L 16
S25S MTFNR/L 16
S32T MTFNR/L 16
S40U MTFNR/L 16
S32T MTFNR/L 22
S40U MTFNR/L 22
S50V MTFNR/L 22

90° **MTFNR / L**



M Sistem/M System

S20R MT-NR/L 16
S25S MT-NR/L 16
S32T MT-NR/L 16
S40U MT-NR/L 16
S32T MT-NR/L 22
S40U MT-NR/L 22
S50U MT-NR/L 22

60° **MT-NR / L**



M Sistem/M System

- S20R MTQNR/L 16
- S25S MTQNR/L 16
- S32T MTQNR/L 16
- S40U MTQNR/L 16
- S32T MTQNR/L 22
- S40U MTQNR/L 22
- S50V MTQNR/L 22

107.5° **MTQNR / L**



M Sistem/M System

- S20R MTUNR/L 16
- S25S MTUNR/L 16
- S32T MTUNR/L 16
- S40U MTUNR/L 16
- S50V MTUNR/L 16
- S32T MTUNR/L 22
- S40U MTUNR/L 22
- S50V MTUNR/L 22

93° **MTUNR / L**



M Sistem/M System

- S16P MWLNR/L 06
- S20R MWLNR/L 06
- S25S MWLNR/L 06
- S25S MWLNR/L 08
- S20R MWLNR/L 08
- S32T MWLNR/L 08
- S40U MWLNR/L 08

95° **MWLNR / L**



P Sistem/P System

- S16P PCLNR/L 09
- S20R PCLNR/L 09
- S25S PCLNR/L 09
- S25S PCLNR/L 12C
- S32T PCLNR/L 12C
- S32U PCLNR/L 12C
- S40U PCLNR/L 12C
- S50V PCLNR/L 12C
- S32T PCLNR/L 16C

- S40U PCLNR/L 16C
- S50V PCLNR/L 16C
- S40U PCLNR/L 19C
- S50V PCLNR/L 19C
- A16R PCLNR/L 09
- A20P PCLNR/L 09
- A25R PCLNR/L 12C
- A25S PCLNR/L 12C
- A32S PCLNR/L 12C

- A32T PCLNR/L 12C
- A40T PCLNR/L 12C
- A50U PCLNR/L 12C
- A32S PCLNR/L 16C
- A40T PCLNR/L 16C
- A50U PCLNR/L 16C
- A40T PCLNR/L 19C
- A50U PCLNR/L 19C

95° **PCLNR / L**



P Sistem/P System

- S32T PDXNR/L 15
- S40U PDXNR/L 15
- S50V PDXNR/L 15
- A32S PDXNR/L 15
- A40T PDXNR/L 15
- A50U PDXNR/L 15

93° **PDXNR / L**



P Sistem/P System

- S20R PDQNR/L 11
- S25S PDQNR/L 11
- S32T PDQNR/L 15
- S40U PDQNR/L 15
- S50V PDQNR/L 15

- S32T PDQNR/L 1504
- S40U PDQNR/L 1504
- S50V PDQNR/L 1504
- A20P PDQNR/L 11
- A25R PDQNR/L 11

- A32S PDQNR/L 15
- A40T PDQNR/L 15
- A50U PDQNR/L 15
- A32S PDQNR/L 1504
- A40T PDQNR/L 1504

107.5° **PDQNR / L**



P Sistem/P System

- S20R PDUNR/L 11
- S25S PDUNR/L 11
- S25S PDUNR/L 15
- S32T PDUNR/L 15
- S40U PDUNR/L 15
- S50V PDUNR/L 15

- A20P PDUNR/L 11
- A25R PDUNR/L 11
- A25S PDUNR/L 11
- A32S PDUNR/L 11
- A32S PDUNR/L 15
- A40T PDUNR/L 15
- A50U PDUNR/L 15

93° **PDUNR / L**



P Sistem/P System

- S25S PSKNR/L 12C
- S32T PSKNR/L 12C
- S40U PSKNR/L 12C
- S50V PSKNR/L 12C
- S32T PSKNR/L 15C
- S40U PSKNR/L 15C
- S50V PSKNR/L 15C
- A25R PSKNR/L 12C

- A32S PSKNR/L 12C
- A40T PSKNR/L 12C
- A50U PSKNR/L 12C
- A32S PSKNR/L 15C
- A40T PSKNR/L 15C
- A50U PSKNR/L 15C

75° **PSKNR / L**



P Sistem/P System

- S16P PTUNR/L 16
- S20R PTUNR/L 16
- S25S PTUNR/L 16C
- S32T PTUNR/L 16C
- S40U PTUNR/L 16C
- S32T PTUNR/L 22C
- S40U PTUNR/L 22C
- S50V PTUNR/L 22C

- A16M PTUNR/L 16
- A20P PTUNR/L 16
- A25R PTUNR/L 16C
- A32S PTUNR/L 16C
- A40T PTUNR/L 16C
- A32S PTUNR/L 22C
- A40T PTUNR/L 22C

93° **PTUNR / L**



P Sistem/P System

- A25R PTFNR/L 16C
- A32S PTFNR/L 16C

90° **PTFNR / L**



P Sistem/P System

- S20R PWLNR/L 06
- S25S PWLNR/L 06
- S32T PWLNR/L 06

- S25S PWLNR/L 08C
- S32T PWLNR/L 08C
- S40U PWLNR/L 08C
- S50V PWLNR/L 08C
- A16M PWLNR/L 06
- A20P PWLNR/L 06

- A25R PWLNR/L 06
- A32S PWLNR/L 06
- A40T PWLNR/L 06C
- A25R PWLNR/L 08C
- A32S PWLNR/L 08C
- A40T PWLNR/L 08C
- A50U PWLNR/L 08C

95° **PWLNR / L**



S Sistem/S System

- S0508H SCLCR/L 03
- S0608H SCLCR/L 06
- S08H SCLCR/L 06
- S08K SCLCR/L 06
- S08M SCLCR/L 06
- S10K SCLCR/L 06
- S12K SCLCR/L 06
- S1216P SCLCR/L 06
- S1620R SCLCR/L 09
- S16R SCLCR/L 09
- S20R SCLCR/L 09

- S16P SCLCR/L 06
- S12K SCLCR/L 09
- S12M SCLCR/L 09
- S1416P SCLCR/L 09
- S16P SCLCR/L 09
- S1620R SCLCR/L 09
- S16R SCLCR/L 09
- S20R SCLCR/L 09
- S20S SCLCR/L 09
- S25S SCLCR/L 09
- S32T SCLCR/L 09
- S25S SCLCR/L 12
- S32T SCLCR/L 12
- S40U SCLCR/L 12
- A08H SCLCR/L 06
- A10H SCLCR/L 06

- S20S SCLCR/L 09
- S25S SCLCR/L 09
- S32T SCLCR/L 09
- S25S SCLCR/L 12
- S32T SCLCR/L 12
- A32S SCLCR/L 12
- A25R SCLCR/L 12



S Sistem/S System

- S08H SCFCR/L 06
- S10K SCFCR/L 06
- S12K SCFCR/L 06
- S12K SCFCR/L 09
- S16P SCFCR/L 09
- S20R SCFCR/L 09
- S25S SCFCR/L 09
- S25S SCFCR/L 12

- S32T SCFCR/L 12
- S40U SCFCR/L 12
- A08H SCFCR/L 06

95° **SCLCR / L**

90° **SCFCR / L**

Delik İçi Tornalama Katerleri / Boring Bars



S Sistem/S System

S10K SD-CR/L 07
S12K SD-CR/L 07
S16P SD-CR/L 07
S20R SD-CR/L 07
S16P SD-CR/L 11
S20R SD-CR/L 11

S25S SD-CR/L 11
S32T SD-CR/L 11
S40U SD-CR/L 11

62.5° **SD-CR / L**



S Sistem/S System

S10K SDPCR/L 07
S12K SDPCR/L 07
S16P SDPCR/L 11
S20R SDPCR/L 11
S25S SDPCR/L 11

117.5° **SDPCR / L**



S Sistem/S System

S10K SDQCR/L 07
S12K SDQCR/L 07
S16P SDQCR/L 07
S20R SDQCR/L 07

S16P SDQCR/L 11
S20R SDQCR/L 11
S25S SDQCR/L 11
S32T SDQCR/L 11
S40U SDQCR/L 11

A10H SDQCR/L 07
A12H SDQCR/L 07
A16M SDQCR/L 07
A20P SDQCR/L 07
A16M SDQCR/L 11
A20P SDQCR/L 11
A25R SDQCR/L 11
A32S SDQCR/L 11

107.5° **SDQCR / L**



S Sistem/S System

S16P SRGCR/L 08
S20R SRGCR/L 08
S25S SRGCR/L 08C
S32T SRGCR/L 08C
S40U SRGCR/L 08C
A16M SRGCR/L 08
A20P SRGCR/L 08
A25R SRGCR/L 08C
A32S SRGCR/L 08C
A40T SRGCR/L 08C

-° **SRGCR / L**



S Sistem/S System

S0810K SDUCR/L 07
S0810M SDUCR/L 07
S10K SDUCR/L 07
S12K SDUCR/L 07
S1216P SDUCR/L 07
S1416P SDUCR/L 07
S16P SDUCR/L 07
S20R SDUCR/L 07

S1416P SDUCR/L 11
S16P SDUCR/L 11
S1620R SDUCR/L 11
S20R SDUCR/L 11
S25S SDUCR/L 11
S25T SDUCR/L 11
S32T SDUCR/L 11

S40U SDUCR/L 11
S50V SDUCR/L 11
A0810H SDUCR/L 07
A10H SDUCR/L 07
A12H SDUCR/L 07
A16M SDUCR/L 07
A20P SDUCR/L 07

A16M SDUCR/L 11
A20P SDUCR/L 11
A25R SDUCR/L 11
A25T SDUCR/L 11
new A40T SDUCR/L 11
A32S SDUCR/L 11
A50U SDUCR/L 11

93° **SDUCR / L**



S Sistem/S System

S12K SDXCR/L 07
S16P SDXCR/L 07
S20R SDXCR/L 07
S16P SDXCR/L 11
S20R SDXCR/L 11
S25S SDXCR/L 11
S32T SDXCR/L 11
S40U SDXCR/L 11

A12H SDXCR/L 07
A16M SDXCR/L 07
A20P SDXCR/L 07
A16M SDXCR/L 11
A20P SDXCR/L 11
A25R SDXCR/L 11
A32S SDXCR/L 11

93° **SDXCR / L**



S Sistem/S System

S16P SSSCR/L 09
S20R SSSCR/L 09
S25S SSSCR/L 09
S25S SSSCR/L 12
S32T SSSCR/L 12
S40U SSSCR/L 12

45° **SSSCR / L**



S Sistem/S System

S12K ST-CR/L 11
S16P ST-CR/L 11
S20R ST-CR/L 11
S16P ST-CR/L 16
S20R ST-CR/L 16
S25S ST-CR/L 16
S32T ST-CR/L 16
S40U ST-CR/L 16

60° **ST-CR / L**



S Sistem/S System

S0610F STFPCR/L 06
S08H STFPCR/L 06
S10K STFPCR/L 09
S12K STFPCR/L 09

S12K STFPCR/L 11
S16P STFPCR/L 11
S20R STFPCR/L 11

S16P STFPCR/L 16
S20R STFPCR/L 16
S25S STFPCR/L 16
S32T STFPCR/L 16
S40U STFPCR/L 16
A10H STFPCR/L 11
A12H STFPCR/L 11
A16M STFPCR/L 11
A20R STFPCR/L 16

90° **STFPCR / L**



S Sistem/S System

S10K STUCR/L 09
S12K STUCR/L 09
S12K STUCR/L 11
S16P STUCR/L 11
S20R STUCR/L 11

S16P STUCR/L 16
S20R STUCR/L 16
S25S STUCR/L 16
S32T STUCR/L 16
S40U STUCR/L 16
A10H STUCR/L 09
A12H STUCR/L 09

A12H STUCR/L 11
A16M STUCR/L 11
A20P STUCR/L 11
A16M STUCR/L 16
A20P STUCR/L 16
A25R STUCR/L 16
A32S STUCR/L 16

93° **STUCR / L**



S Sistem/S System

S08H STUPR/L 0802
S10K STUPR/L 1103
S12K STUPR/L 1103
S12M STUPR/L 1103
S16P STUPR/L 1103
S16R STUPR/L 1103
A20R STUPR/L 1103

93° **STUPR / L**



S Sistem/S System

S25S SVJBR/L 16
S32T SVJBR/L 16
S40U SVJBR/L 16

93° SVJBR / L



S Sistem/S System

S12K SVJCR/L 11
S16P SVJCR/L 11
S20R SVJCR/L 11
A12H SVJCR/L 11
A16M SVJCR/L 11
A20P SVJCR/L 11

93° SVJCR / L



S Sistem/S System

S16P SVQBR/L 11
S20R SVQBR/L 11
S25S SVQBR/L 16
S32T SVQBR/L 16
S40U SVQBR/L 16
A20Q SVQBR/L 11
A20Q SVQBR/L 16
A25S SVQBR/L 16
A32S SVQBR/L 16

107.5° SVQBR / L



S Sistem/S System

S16P SVQCR/L 11
S20R SVQCR/L 11
S25S SVQCR/L 16
S32T SVQCR/L 16
S40U SVQCR/L 16
A16M SVQCR/L 11
A20P SVQCR/L 11
A25R SVQCR/L 16
A32S SVQCR/L 16
A40T SVQCR/L 16

107.5° SVQCR / L



S Sistem/S System

S16P SVUBR/L 11
S20R SVUBR/L 11
S25S SVUBR/L 16
S32T SVUBR/L 16
S40U SVUBR/L 16
A20Q SVUBR/L 16
A32S SVUBR/L 16

93° SVUBR / L



S Sistem/S System

S16P SVUCR/L 11
S20R SVUCR/L 11
S25S SVUCR/L 16
S32T SVUCR/L 16
S40U SVUCR/L 16
A12K SVUCR/L 07
A20Q SVUCR/L 11
A25R SVUCR/L 16

93° SVUCR / L



S Sistem/S System

S16P SVXBR/L 1102
S20R SVXBR/L 1102
S16P SVXBR/L 11
S20R SVXBR/L 11
S25S SVXBR/L 16
S32T SVXBR/L 16
S40U SVXBR/L 16

93° SVXBR / L



S Sistem/S System

S0608H SWLCR/L 03
S0810K SWLCR/L 03

95° SWLCR / L



S Sistem/S System

S0610H SWUBR/L 06
S08H SWUBR/L 06-5.5
S08H SWUBR/L 06-7

93° SWUBR / L



S Sistem Carbür Şaftlı
S System Carbide Shank

C04G SCLCR/L 03 E08K SCLCR/L 06
C05H SCLCR/L 03 E10M SCLCR/L 06
C06J SCLCR/L 04 E12Q SCLCR/L 06
C07K SCLCR/L 04 E16R SCLCR/L 09
C06J SCLCR/L 06 E20S SCLCR/L 09

95° SCLCR / L



S Sistem Carbür Şaftlı
S System Carbide Shank

E10M SDUCR/L 07
E12Q SDUCR/L 07
E16R SDUCR/L 11
E20S SDUCR/L 11

93° SDUCR / L



S Sistem/S System

E08K STFCL/L 06
E10M STFCL/L 09
E12Q STFCL/L 09
E12Q STFCL/L 11

90° STFCL / L



S Sistem/S System

E12Q STUPR/L 1103
E16R STUPR/L 1103

93° STUPR / L

S-Sistem Delik İçi Tornalama Kater Setleri / S-System Boring Bars Sets



S Sistem/S System

A08H SCLCR/L 06
A10H SCLCR/L 06
A12H SCLCR/L 06
A16M SCLCR/L 09

95° SET-A/SCLCR / L



S Sistem/S System

E08K SCLCR/L 06
E10M SCLCR/L 06
E12Q SCLCR/L 06
E16R SCLCR/L 09

95° SET-E/SCLCR / L



S Sistem/S System

S08H SCLCR/L 06
S10K SCLCR/L 06
S12K SCLCR/L 06
S16P SCLCR/L 09

95° SET-S/SCLCR / L

S-Sistem Delik İçi Tornalama Kater Setleri / S-System Boring Bars Sets

	<p>S Sistem/S System</p> <p>A10H SDUCR/L 07 A12H SDUCR/L 07 A16M SDUCR/L 11</p>		<p>S Sistem/S System</p> <p>E10M SDUCR/L 07 E12Q SDUCR/L 07 E16R SDUCR/L 11</p>		<p>S Sistem/S System</p> <p>S10K SDUCR/L 07 S12K SDUCR/L 07 S16P SDUCR/L 11</p>
<p>93° SET-A/SDUCR/L</p>		<p>93° SET-E/SDUCR/L</p>		<p>93° SET-S/SDUCR/L</p>	

Kartuşlar / Cartridges

	<p>S Sistem/S System</p> <p>S10X SCACR/L 06 S10A SCACR/L 06 S1018 SCACR/L 06 S1065 SCACR/L 06 S10C SCACR/L 06 S12B SCACR/L 06 S12D SCACR/L 06 S12D SCACR/L 09</p> <p>S1265 SCACR/L 09 S12H SCACR/L 09 S15C SCACR/L 09 S1554 SCACR/L 09 S15E SCACR/L 09 S15D SCACR/L 09 S16A SCACR/L 09 S16B SCACR/L 09</p> <p>S16C SCACR/L 09 S16D SCACR/L 09 S16E SCACR/L 09 S16G SCACR/L 09 S16H SCACR/L 09 S1868 SCACR/L 09 S18E SCACR/L 09 S1888 SCACR/L 09</p> <p>S18105 SCACR/L 09 S18175 SCACR/L 09 S20E SCACR/L 09 S20E SCACR/L 12 S20H SCACR/L 12</p>				
<p>90° SCACR / L</p>					
	<p>S Sistem/S System</p> <p>S08A SCMCN 06 S10X SCMCN 06 S10A SCMCN 06 S10B SCMCN 06 S10C SCMCN 06 S10D SCMCN 06 S12D SCMCN 06 S16C SCMCN 09 S16D SCMCN 09</p>		<p>S Sistem/S System</p> <p>S12D SRSCN 10 S14D SRSCN 10 S16D SRSCN 10</p>		<p>S Sistem/S System</p> <p>STXCR/L 2020 B16 STXCR/L 2020 E16 STXCR/L 2020 B16-SA STXCR/L 2020 E16-SA STXCR/L 2020 B16-PL STXCR/L 2020 E16-PL STXCR/L 2020 H16-PL</p>
<p>50° SCMCN</p>		<p>-° SRSCN</p>		<p>-° STXCR / L</p>	
	<p>S Sistem/S System</p> <p>06CA 06 08CA 06 10CA 09 12CA 12 16CA 12</p>		<p>S Sistem/S System</p> <p>08CA 06 10CA 09 12CA 09 12CA 12</p>		<p>S Sistem/S System</p> <p>06CA 06 10CA 09 12CA 12</p>
<p>90° SCFCR / L</p>		<p>95° SCLCR / L</p>		<p>45° SCSCR / L</p>	
	<p>S Sistem/S System</p> <p>SDJCR/L 10CA 07 SDJCR/L 12CA 11</p>		<p>S Sistem/S System</p> <p>10CA 09 12CA 12</p>		<p>S Sistem/S System</p> <p>08CA 09 10CA 11 12CA 16 16CA 16</p>
<p>-° SDJCR / L</p>		<p>75° SSKCR / L</p>		<p>90° STFCR / L</p>	
	<p>S Sistem/S System</p> <p>08CA 09 10CA 11 12CA 16</p>		<p>S Sistem/S System</p> <p>08CA 09 10CA 11 12CA 16</p>		<p>P Sistem/P System</p> <p>16CA 12 20CA 15</p>
<p>45° STSCR / L</p>		<p>60° STTCR / L</p>		<p>75° PSKNR / L</p>	
					<p>75° PSRNR / L</p>



Kartuşlar / Cartridges

	P Sistem/P System 12CA 16 16CA 16 16CA 22 20CA 22		P Sistem/P System 16CA 22		P Sistem/P System S22D PSDNN 12C
90° PTFNR / L		90° PTGNR / L		45° PSDNN	



Tırlamaz Takımlar / Antivibration Tools

	Tırlamaz Takımların Gövdesi / Anti Vibration Tools Shank ATTB-D16-156-7D-H ATTB-D16-204-10D-H-E ATTB-D20-200-7D-H ATTB-D20-260-10D-H-E ATTB-D25-255-7D-H ATTB-D25-330-10D-H ATTB-D32-320-7D-H		Kartuşlar / Cartridges ATTC-A16 SDUCR/L 07 ATTC-A20 SDUCR/L 11 ATTC-A25 SDUCR/L 11 ATTC-A32 SDUCR/L 11 ATTC-A40 SDUCR/L 11
ATTB	ATTB-D32-416-10D-H ATTB-D40-408-7D-H ATTB-D40-528-10D-H ATTB-D50-519-7D-H ATTB-D50-669-10D-H ATTB-D60-628-7D-H ATTB-D60-808-10D-H	93° SDUCR / L	
	Kartuşlar / Cartridges ATTC-A16 SCLCR/L 06 ATTC-A20 SCLCR/L 09 ATTC-A25 SCLCR/L 09 ATTC-A32 SCLCR/L 09 ATTC-A40 SCLCR/L 09 ATTC-A40 SCLCR/L 12		Kartuşlar / Cartridges ATTC-A20 SVUCR/L 11 ATTC-A25 SVUCR/L 11 ATTC-A32 SVUCR/L 16 ATTC-A40 SVUCR/L 16
95° SCLCR / L		93° SVUCR / L	Kartuşlar / Cartridges ATTC-A20 STFCCR/L 11 ATTC-A40 STFCCR/L 11
	Kartuşlar / Cartridges ATTC-A32 TDUNR/L 11 ATTC-A40 TDUNR/L 15		Kartuşlar / Cartridges ATTC-A40 TTFNR/L 16
93° TDUNR / L		90° TTFNR / L	Kartuşlar / Cartridges ATTC-A32 TCLNR/L 12 ATTC-A40 TCLNR/L 12 new ATTC-A40 TCLNR/L 16
	Kartuşlar / Cartridges ATTC-A40 MVUNR/L 16		Merkezleme Aparatı / Centering Instrument ATTC-16-25 ATTC-32-60
new 93° MVUNR / L		93° ATTC	

Boru Pahlama Takımları / Pipe Beveling and Chamfering Tools

	<table border="1"> <thead> <tr> <th>Takım Kodu / Tool Code</th> <th colspan="2">Dmax</th> <th colspan="2">Dmin</th> <th>Max (Out-Din)</th> </tr> <tr> <th></th> <th>D in</th> <th>D out</th> <th>D in</th> <th>D out</th> <th></th> </tr> </thead> <tbody> <tr><td>ACPBT-1</td><td>27-52</td><td>52</td><td>18-36</td><td>36</td><td>27</td></tr> <tr><td>ACPBT-2</td><td>27-49</td><td>52</td><td>25-36</td><td>36</td><td>27</td></tr> <tr><td>ACPBT-3</td><td>48-75</td><td>75</td><td>41</td><td>42</td><td>27</td></tr> <tr><td>ACPBT-4</td><td>51-75</td><td>75</td><td>51</td><td>52</td><td>27</td></tr> <tr><td>ACPBT-5</td><td>22-35</td><td>35</td><td>22</td><td>23</td><td>27</td></tr> <tr><td>ACPBT-6</td><td>15-35</td><td>35</td><td>15</td><td>16</td><td>27</td></tr> <tr><td>ACPBT-7</td><td>49-53</td><td>75</td><td>32-36</td><td>36</td><td>27</td></tr> <tr><td>ACPBT-8</td><td>49</td><td>75</td><td>33-37</td><td>37</td><td>27</td></tr> </tbody> </table>	Takım Kodu / Tool Code	Dmax		Dmin		Max (Out-Din)		D in	D out	D in	D out		ACPBT-1	27-52	52	18-36	36	27	ACPBT-2	27-49	52	25-36	36	27	ACPBT-3	48-75	75	41	42	27	ACPBT-4	51-75	75	51	52	27	ACPBT-5	22-35	35	22	23	27	ACPBT-6	15-35	35	15	16	27	ACPBT-7	49-53	75	32-36	36	27	ACPBT-8	49	75	33-37	37	27		<table border="1"> <thead> <tr> <th>Takım Kodu / Tool Code</th> <th colspan="2">D1</th> <th colspan="2">D2</th> </tr> <tr> <th></th> <th>Dmax</th> <th>Dmin</th> <th></th> <th></th> </tr> </thead> <tbody> <tr><td>ACPBT-9</td><td>38</td><td>24</td><td>15</td><td>1</td></tr> <tr><td>ACPBT-10</td><td>78</td><td>64</td><td>43</td><td>29</td></tr> </tbody> </table>	Takım Kodu / Tool Code	D1		D2			Dmax	Dmin			ACPBT-9	38	24	15	1	ACPBT-10	78	64	43	29		Takım Adı/Tool Code ÖTG-TC11-4IL ÖTG-TC11-4IR ÖTG-TC16-1AL ÖTG-TC16-1AR ÖTG-TC16-2DL ÖTG-TC16-2DR ÖTG-TC16-3IL ÖTG-TC16-3IR
Takım Kodu / Tool Code	Dmax		Dmin		Max (Out-Din)																																																																																
	D in	D out	D in	D out																																																																																	
ACPBT-1	27-52	52	18-36	36	27																																																																																
ACPBT-2	27-49	52	25-36	36	27																																																																																
ACPBT-3	48-75	75	41	42	27																																																																																
ACPBT-4	51-75	75	51	52	27																																																																																
ACPBT-5	22-35	35	22	23	27																																																																																
ACPBT-6	15-35	35	15	16	27																																																																																
ACPBT-7	49-53	75	32-36	36	27																																																																																
ACPBT-8	49	75	33-37	37	27																																																																																
Takım Kodu / Tool Code	D1		D2																																																																																		
	Dmax	Dmin																																																																																			
ACPBT-9	38	24	15	1																																																																																	
ACPBT-10	78	64	43	29																																																																																	
				-° ÖTG-TC..																																																																																	

Dış Çap ve Delik İçi Diş Açma Takımları / External and Internal Threading Toolholders

Dış Çap Diş Açma/External Threading Toolholders		Dış Çap Diş Açma İsviçre Tipi Kayar Otomat Makina Katerleri / External Threading Toolholders For Swiss Type Sliding Automatic Lathes	
	0808 E11 1010 E11 1212 F 11 1616 H11 2020 H11 1616 H16C 2020 K16C	2525 M16C 3232 P16C 2525 M22C 3232 P22C 4040 S22C	2525 M16C-T 2525 M22C-T 2020 K16C-S 2525 M16C-S 3232 P16C-S
SER / L			SER / L
	Dış Çap Diş Açma/ External Threading Toolholders 1616 H16 2020 K16 2525 M16 3232 P16 2525 M22 3232 P22 4040 S22 2525 M27 3232 P27 4040 S27		Delik İçi Diş Açma Takımları/Internal Threading Toolholders S12X05H 06 S16X05H 06 S16X07M 08 S10H 11 A10H 11 S12K 11 A12K 11 S16X10M 11 S16X13M 11 S16M 11 A16X13M 16 S16X13M 16
TER / L		SIR / L	
			Delik İçi Diş Açma Takımları/ Internal Threading Toolholders A20P 16 A25R 16 A32S 16 A40T 16 S25R 16 S32S 16 S40T 16 S50U 16 S25R 22 S32S 22 S40T 22 S50U 22 S32S 27 S40T 27 S50U 27
			TIR / L

Kesme ve Kanal Açma Uçları / Parting and Grooving Inserts

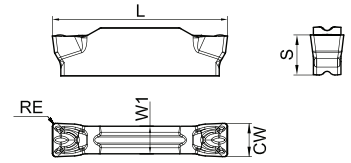

AGD-MT

AKKO Çift Taraflı Kesme Uçları
AKKO Grooving Double Side



Sipariş Kodu Ordering Code	Ölçü / Dimension (mm)					Kaplama Karbürleri/Coated Carbides		
	CW±0.05	RE±0.05	L	W1	S	AP1225	AK1115	AA4230
AGD2002-MT	2.0	0.2	16.0	1.2	3.5	●	●	●
AGD2502-MT	2.5	0.2	18.5	2.0	3.85	●	●	●
AGD3004-MT	3.0	0.4	21.2	2.35	4.8	●	●	●
AGD4004-MT	4.0	0.4	21.0	3.3	4.8	●	●	●
AGD5004-MT	5.0	0.4	26.0	4.1	5.8	●	●	●
AGD5008-MT	5.0	0.8	26.0	4.1	5.8	●	●	●
AGD6004-MT	6.0	0.4	26.0	5.0	5.8	●	●	●
AGD6008-MT	6.0	0.8	26.0	5.0	5.8	●	●	●
AGD8008-MT	8.0	0.8	31.0	6.0	6.5	●	●	●

● Stok Stock ○ Talep Edilmesi Halinde Üretililecek Available upon order

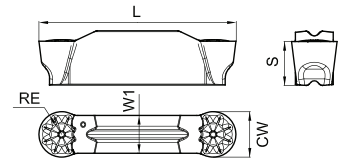

AGD-MR

AKKO Çift Taraflı Kesme Uçları
AKKO Grooving Double Side

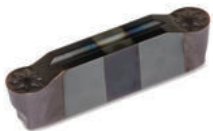

Sipariş Kodu Ordering Code	Ölçü / Dimension (mm)					Kaplama Karbürleri/Coated Carbides			
	CW±0.05	RE±0.05	L	W1	S	AP1105	AP1225	AK1115	AA4230
AGD2010-MR	2.0	1.0	16.0	1.2	3.5	●	●	●	●
AGD3015-MR	3.0	1.5	21.2	2.35	4.8	●	●	●	●
AGD4020-MR	4.0	2.0	21.0	3.3	4.8	●	●	●	●
AGD5025-MR	5.0	2.5	26.0	4.1	5.8	●	●	●	●
AGD6030-MR	6.0	3.0	26.0	5.0	5.8	●	●	●	●
AGD8040-MR	8.0	4.0	31.0	6.0	6.5	●	●	●	●

● Stok Stock ○ Talep Edilmesi Halinde Üretililecek Available upon order

ISO	İs Parçası Malzemesi Workpiece Material	Sertlik Hardness (HB)	Kesme Hızı / Cutting Speed Vc m/min						
			AP1105	AP1225	AK1115	AS3115	AS3125	AA4230	AS9125
P	Düşük Karbonlu Çelik Low Carbon Steel	80 - 170	120 (80-220)	120 (80-220)		70 (50-100)	70 (50-100)	110 (70-180)	
	Yüksek Karbonlu Çelik High Carbon Steel	170 - 250	120 (80-220)	120 (80-220)				110 (70-150)	
	Düşük Alaşımli Çelik Low-alloy Steel	140 - 260	110 (60-180)	110 (60-180)		70 (50-100)	70 (50-100)	(40-150)	
	Yüksek Alaşımli Çelik High-alloy Steel	180 - 300	110 (60-180)	110 (60-180)				110 (40-150)	
	Dökme Çelik Cast Steel	180 - 300	110 (60-180)	110 (60-180)				110 (40-150)	
M	Feritik / Martenzitik Ferritic / Martensitic	150 - 270				90 (50-150)	90 (30-180)	110 (40-180)	
	Östenitik Austenitic	150 - 270				90 (50-150)	90 (30-180)	(40-180)	
K	Dövülebilir Dökme Demir Malleable Cast Iron	150 - 230			130 (50-200)			(50-180)	
	Gri Dökme Demir Gray Cast Iron	150 - 230			130 (50-200)			110 (50-180)	
	Sferö Döküm Demir Nodular Cast Iron	160 - 260			100 (50-150)			100 (50-150)	
S	Isıya Dayanımlı Alaşımlar Heat-resistant Alloy	130 - 400				35 (15-60)	35 (15-70)		
	Titanyum Alaşımlar Titanium Alloys	130 - 400				35 (15-60)	35 (15-70)		35 (15-60)

Kanal Açma Takımları / Grooving Toolholders

Kesme ve Derin Kanal Açma Lama Bloğu
Blocks For Parting and Deep Grooving Blades



ALBU

ALBU-20-26
ALBU-20-32
ALBU-25-26
ALBU-25-32
ALBU-32-32



ALBU

ALBU-20-32-H
ALBU-25-32-H
ALBU-32-32-H

Kanal Açma Takımları / Grooving Toolholders



AKKO UCUNA UYGUNDUR.
COMPATIBLE WITH
AKKO INSERT.

ADKT-K-R/L-1212-1.5-T15
ADKT-K-R/L-2020-1.5-T15
ADKT-K-R/L-1212-2-T15
ADKT-K-R/L-1616-2-T10
ADKT-K-R/L-1616-2-T15
ADKT-K-R/L-2020-2-T15
ADKT-K-R/L-2525-2-T15
ADKT-K-R/L-3232-2-T15
ADKT-K-R/L-2020-3-T10
ADKT-K-R/L-1212-3-T15
ADKT-K-R/L-1616-3-T7
ADKT-K-R/L-1616-3-T15
ADKT-K-R/L-2020-3-T20
ADKT-K-R/L-2020-3-R28

ADKT-K-R/L-2525-3-T10
ADKT-K-R/L-2525-3-R15
ADKT-K-R/L-2525-3-T22
ADKT-K-R/L-2525-3-T30
ADKT-K-R/L-3232-3-T10
ADKT-K-R/L-3232-3-T22
ADKT-K-R/L-2020-4-T20
ADKT-K-R/L-2525-4-T22
ADKT-K-R/L-3232-4-T22
ADKT-K-R/L-2020-4-T10
ADKT-K-R/L-2020-5-T20
ADKT-K-R/L-2525-5-T18
ADKT-K-R/L-2525-5-T25
ADKT-K-R/L-3232-5-T25

ADKT-K-R/L-2525-6-T25
ADKT-K-R/L-3232-6-T25
ADKT-K-R/L-3232-8-T32
ADKT-K-R/L-2020-4-R25
ADKT-K-R/L-2525-4-T10
ADKT-K-R/L-2525-4-T18
ADKT-K-R/L-3232-4-T10
ADKT-K-R/L-2525-5-T15
ADKT-K-R/L-3232-5-T15
ADKT-K-R/L-2525-6-T15
ADKT-K-R/L-2525-6-T25



AKKO UCUNA UYGUNDUR.
COMPATIBLE WITH AKKO INSERT.

ADKT-K-R/L-1616-2-T10-H
ADKT-K-R/L-1616-3-T15-H
ADKT-K-R/L-2020-3-R22-H
ADKT-K-R/L-2020-3-T20-H
ADKT-K-R/L-2525-3-T22-H
ADKT-K-R/L-2020-4-T20-H
ADKT-K-R/L-2525-4-T22-H
ADKT-K-R/L-2525-5-T25-H



AKKO UCUNA UYGUNDUR.
COMPATIBLE WITH AKKO INSERT.

AAKT-K-R/L-2525-34-45-3-T17
AAKT-K-R/L-2525-39-55-3-T17
AAKT-K-R/L-2525-49-80-3-T17
AAKT-K-R/L-2525-70-110-3-T17
AAKT-K-R/L-2525-100-150-3-T17
AAKT-K-R/L-2525-80-180-3-T32
AAKT-K-R/L-2525-175-215-3-T22
AAKT-K-R/L-2525-700-800-3-T17
AAKT-K-R/L-3232-140-450-3-T17

AAKT-K-R/L-2525-50-85-4-T22
AAKT-K-R/L-2525-70-110-4-T22
AAKT-K-R/L-2525-100-150-4-T22
AAKT-K-R/L-2525-80-180-4-T32
AAKT-K-R/L-2525-180-800-4-T32
AAKT-K-R/L-2525-70-110-5-T25
AAKT-K-R/L-2525-100-150-5-T25
AAKT-K-R/L-2525-100-200-5-T45
AAKT-K-R/L-2525-80-180-5-T32

AAKT-K-R/L-2525-140-200-5-T25
AAKT-K-R/L-2525-180-800-5-T32
AAKT-K-R/L-2525-180-800-5-T40
AAKT-K-R/L-3232-300-400-5-T25
AAKT-K-R/L-2525-60-100-6-T25
AAKT-K-R/L-2525-60-100-6-T35
AAKT-K-R/L-2525-100-200-6-T25
AAKT-K-R/L-2525-100-200-6-T35
AAKT-K-R/L-2525-100-200-6-T45

AAKT-K-R/L-2525-140-300-6-T35
AAKT-K-R/L-2525-180-360-6-T40
AAKT-K-R/L-3232-140-800-6-T25
AAKT-K-R/L-3232-180-800-6-T41
AAKT-K-R/L-3232-400-500-6-T25
AAKT-K-R/L-2525-140-300-8-T35
AAKT-K-R/L-3232-140-350-8-T35

Kanal Açma Takımları / Grooving Toolholders



ADKT-K-R/L-1212-2-R12-K-S
ADKT-K-R/L-1616-2-R16-K-S
ADKT-K-R/L-1212-3-R12-K-S
ADKT-K-R/L-1616-3-R16-K-S

AKKO UCUNA UYGUNDUR.
COMPATIBLE WITH AKKO INSERT.



AIKT-K-R/L-16-2-T4
AIKT-K-R/L-20-2-T4
AIKT-K-R/L-25-2-T6
new AIKT-K-R/L-16-3-T7
AIKT-K-R/L-20-3-T6
AIKT-K-R/L-20-3-T7
AIKT-K-R/L-25-3-T6
AIKT-K-R/L-25-3-T10

AKKO UCUNA UYGUNDUR.
COMPATIBLE WITH AKKO INSERT.

AIKT-K-R/L-32-3-T6
AIKT-K-R/L-32-3-T12
AIKT-K-R/L-40-3-T6
AIKT-K-R/L-40-3-T12
AIKT-K-R/L-20-4-T6
AIKT-K-R/L-20-4-T7
AIKT-K-R/L-25-4-T6
AIKT-K-R/L-25-4-T10

AIKT-K-R/L-32-4-T6
AIKT-K-R/L-32-4-T12
AIKT-K-R/L-40-4-T6
AIKT-K-R/L-40-4-T12
AIKT-K-R/L-25-5-T7
AIKT-K-R/L-32-5-T7
AIKT-K-R/L-40-5-T7
AIKT-K-R/L-40-5-T12



AKL-K-32-2
AKL-K-32-3
AKL-K-32-4

AKKO UCUNA UYGUNDUR.
COMPATIBLE WITH AKKO INSERT.



ADKT-ARN-R/L-2020-2-T15
ADKT-ARN-R/L-2525-2-T15
ADKT-ARN-R/L-2020-3-T20
ADKT-ARN-R/L-2525-3-T22

ARN UCUNA UYGUNDUR.
COMPATIBLE WITH ARN INSERT.



ADKT-SA24-R/L-1212-2-R10-S
ADKT-SA24-R/L-1616-2-R16-S

ARN UCUNA UYGUNDUR.
COMPATIBLE WITH ARN INSERT.



ADKT-CD-R/L-2020-3-R20
ADKT-CD-R/L-2525-3-R23

CRTZT UCUNA UYGUNDUR.
COMPATIBLE WITH CRTZT INSERT.



ADKT-GX09-R/L-1212-2-R7-K-S
ADKT-GX16-R/L-2020-2-T13
ADKT-GX16-R/L-2020-3-T13
ADKT-GX16-R/L-2020-4-T13
ADKT-GX24-R/L-2525-3-T21
ADKT-GX24-R/L-2525-4-T21

CRTZT UCUNA UYGUNDUR.
COMPATIBLE WITH CRTZT INSERT.



ADKT-H-R/L-2020-3-T20
ADKT-H-R/L-2525-3-T22
ADKT-H-R/L-2525-3-T26
ADKT-H-R/L-2020-4-T20
ADKT-H-R/L-2525-4-T22
ADKT-H-R/L-3232-4-T22
ADKT-H-R/L-2020-5-T20
ADKT-H-R/L-2525-5-T25
ADKT-H-R/L-2525-6-T25

HRN UCUNA UYGUNDUR.
COMPATIBLE WITH HRN INSERT.



AIKT-H-R/L-25-3-T8
AIKT-H-R/L-32-3-T7
AIKT-H-R/L-40-3-T7
AIKT-H-R/L-25-4-T8
AIKT-H-R/L-32-4-T7
AIKT-H-R/L-40-4-T7
AIKT-H-R/L-25-5-T8
AIKT-H-R/L-32-5-T7
AIKT-H-R/L-40-5-T7

HRN UCUNA UYGUNDUR.
COMPATIBLE WITH HRN INSERT.



ADKT-HK-R/L-1616-2-T15
ADKT-HK-R/L-2020-2-T15
ADKT-HK-R/L-2525-2-T15
ADKT-HK-R/L-1616-3-T15
ADKT-HK-R/L-2020-3-T20
ADKT-HK-R/L-2525-3-T22
ADKT-HK-R/L-2020-4-T20
ADKT-HK-R/L-2525-4-T22
ADKT-HS223-R/L-2020-2-T15
ADKT-HS223-R/L-2020-3-T17

HRN UCUNA UYGUNDUR.
COMPATIBLE WITH HRN INSERT.



AIKT-HK-R/L-20-2-T6
AIKT-HK-R/L-25-2-T6
AIKT-HK-R/L-20-3-T6
AIKT-HK-R/L-25-3-T6
AIKT-HK-R/L-32-3-T6
AIKT-HK-R/L-20-4-T6
AIKT-HK-R/L-25-4-T6
AIKT-HK-R/L-32-4-T6
AIKT-HS223-R/L-20-2-T5
AIKT-HS223-R/L-25-2-T5
AIKT-HS223-R/L-20-3-T6
AIKT-HS223-R/L-25-3-T6

HRN UCUNA UYGUNDUR.
COMPATIBLE WITH HRN INSERT.



ADKT-H22-R/L-1616-(0.5-2)-T4
ADKT-H22-R/L-2020-(0.5-2)-T4
ADKT-H22-R/L-2020-(0.5-2)-T6x20
ADKT-H22-R/L-2525-(0.5-2)-T4
ADKT-H22-R/L-2525-(0.5-2)-T6x20

HRN UCUNA UYGUNDUR.
COMPATIBLE WITH HRN INSERT.



ADKT-I-R/L-1212-2-T15
ADKT-I-R/L-1616-2-T15
ADKT-I-R/L-2020-2-T15
ADKT-I-R/L-2525-2-T15
ADKT-I-R/L-3232-2-T15
ADKT-I-R/L-1212-3-T15
ADKT-I-R/L-1616-3-T15
ADKT-I-R/L-2020-3-T12
ADKT-I-R/L-2020-3-T20
ADKT-I-R/L-2525-3-T12
ADKT-I-R/L-2525-3-T22
ADKT-I-R/L-3232-3-T22
ADKT-I-R/L-2020-4-T20
ADKT-I-R/L-2525-4-T12

ISCR UCUNA UYGUNDUR.
COMPATIBLE WITH ISCR INSERT.

ADKT-I-R/L-2525-4-T22
new ADKT-I-R/L-2525-4-T25
ADKT-I-R/L-3232-4-T25
ADKT-I-R/L-2020-5-T20
ADKT-I-R/L-2525-5-T12
ADKT-I-R/L-2525-5-T25
ADKT-IG-R/L-1616-3-T18
ADKT-IG-R/L-2020-3-T12
ADKT-IG-R/L-2020-3-R20
ADKT-IG-R/L-2525-3-T12
ADKT-IG-R/L-2525-3-T22
ADKT-IGI-R/L-2020-2-T15
ADKT-IGI-R/L-2525-2-T15
ADKT-IGI-R/L-1616-3-T15

ADKT-IGI-R/L-2020-3-T20
ADKT-IGI-R/L-2525-3-T9
ADKT-IGI-R/L-2525-3-T22
ADKT-IGI-R/L-2525-4-T22
ADKT-IGI-R/L-2525-5-T25
ADKT-IGI-R/L-2525-8-T25
ADKT-IGI-R/L-2525-8-T30
ADKT-IDC-R/L-1616-2-D35
ADKT-IDC-R/L-2020-2-R23
ADKT-IDC-R/L-2525-2-R23
ADKT-IDC-R/L-1616-3-D35
ADKT-IDC-R/L-2525-3-T21



ADKT-I-R/L-0808-2-R10-S
ADKT-I-R/L-1010-2-R10-K-S
ADKT-I-R/L-1212-2-R12-K-S
ADKT-I-R/L-1616-2-R16-K-S
ADKT-I-R/L-1616-3-R16-K-S

ISCR UCUNA UYGUNDUR.
COMPATIBLE WITH ISCR INSERT.



AAKT-IG-R/L-2525-40-60-4-T25
AAKT-IG-R/L-2525-52-80-4-T25
AAKT-IG-R/L-2525-70-110-4-T28
AAKT-IG-R/L-2525-72-110-4-T25
AAKT-IG-R/L-2525-100-150-4-T25
AAKT-IG-R/L-2525-110-200-4-T28
AAKT-IG-R/L-2525-110-200-4-T32
AAKT-IG-R/L-2525-140-200-4-T25
AAKT-IG-R/L-2525-180-800-4-T28
AAKT-IG-R/L-2525-200-800-4-T25
AAKT-IG-R/L-2525-70-110-5-T32
AAKT-IG-R/L-2525-110-200-5-T9
AAKT-IG-R/L-2525-110-200-5-T32
AAKT-IG-R/L-2525-180-800-5-T32
AAKT-IG-R/L-2525-58-100-6-T32
AAKT-IG-R/L-2525-88-180-6-T32

ISCR UCUNA UYGUNDUR.
COMPATIBLE WITH ISCR INSERT.



AKL-I-26-2
AKL-I-32-2
AKL-I-26-3
AKL-I-32-3
AKL-I-26-4
AKL-I-32-4

ISCR UCUNA UYGUNDUR.
COMPATIBLE WITH ISCR INSERT.



AIKT-I-R/L-20-3-T5
AIKT-I-R/L-25-3-T6

ISCR UCUNA UYGUNDUR.
COMPATIBLE WITH ISCR INSERT.



AIKT-IG-R/L-25-4-T10-H
AIKT-IG-R/L-32-4-T10-H
AIKT-IG-R/L-40-4-T12-H
AIKT-IG-R/L-25-5-T10-H
AIKT-IG-R/L-32-5-T10-H
AIKT-IG-R/L-40-5-T12-H
AIKT-IG-R/L-50-5-T12-H

ISCR UCUNA UYGUNDUR.
COMPATIBLE WITH ISCR INSERT.



ADKT-ITG-R/L-2020-3-T8
ADKT-ITG-R/L-2525-3-T8
ADKT-ITG-R/L-3232-3-T8
ADKT-ITG-R/L-2020-4-T9
ADKT-ITG-R/L-2525-4-T17
ADKT-ITG-R/L-3232-4-T17
ADKT-ITG-R/L-3232-5-T25

ISCR UCUNA UYGUNDUR.
COMPATIBLE WITH ISCR INSERT.



ADKT-ITI-R/L-2020-2-T15
ADKT-ITI-R/L-2525-2-T15

ISCR UCUNA UYGUNDUR.
COMPATIBLE WITH ISCR INSERT.



AIKT-ITG-R/L-16-3-T6-H
AIKT-ITG-R/L-20-3-T6-H
AIKT-ITG-R/L-25-3-T8-H
AIKT-ITG-R/L-32-3-T8-H
AIKT-ITG-R/L-20-4-T6-H
AIKT-ITG-R/L-25-4-T7-H
AIKT-ITG-R/L-25-4-T9-H
AIKT-ITG-R/L-32-4-T11-H
AIKT-ITG-R/L-40-4-T11-H
AIKT-ITG-R/L-32-6.35-T17.5-H

ISCR UCUNA UYGUNDUR.
COMPATIBLE WITH ISCR INSERT.



AIKT-IGE-R/L-10-2-T3-H
AIKT-IGE-R/L-16-2-T3-D11.5
AIKT-IGE-R/L-16-2-T3-D11.5-H
AIKT-IGE-R/L-16-2-T2.5-H
AIKT-IGE-R/L-20-2-T4-H
AIKT-IGE-R/L-16-3-T2.5-H
AIKT-IGE-R/L-16-3-T2.5-D20

ISCR UCUNA UYGUNDUR.
COMPATIBLE WITH ISCR INSERT.



AIKT-IGI-R/L-20-3-T4
AIKT-IGI-R/L-25-3-T5
AIKT-IGI-R/L-32-3-T5
AIKT-IGI-R/L-40-3-T5
AIKT-IGI-R/L-20-4-T4
AIKT-IGI-R/L-25-5-T10
AIKT-IGI-R/L-25-5-T10-H
AIKT-IGI-R/L-25-5-T15
AIKT-IGI-R/L-25-5-T15-H

ISCR UCUNA UYGUNDUR.
COMPATIBLE WITH ISCR INSERT.



ADKT-KM-R/L-2020-2-T15
ADKT-KM-R/L-2525-2-T15
ADKT-KM-R/L-2020-3-T20
ADKT-KM-R/L-2525-3-T22
ADKT-KM-R/L-2525-4-T22

KNMTL UCUNA UYGUNDUR.
COMPATIBLE WITH KNMTL INSERT.



AIKT-KM-R/L-20-2-T7
AIKT-KM-R/L-20-3-T7
AIKT-KM-R/L-25-3-T10
AIKT-KM-R/L-32-3-T12
AIKT-KM-R/L-40-3-T12
AIKT-KM-R/L-20-4-T7
AIKT-KM-R/L-32-4-T12.2-H

KNMTL UCUNA UYGUNDUR.
COMPATIBLE WITH KNMTL INSERT.



ADKT-K-R/L-1212-1.5-T15
ADKT-K-R/L-2020-1.5-T15
ADKT-K-R/L-1212-2-T15
ADKT-K-R/L-1616-2-T10
ADKT-K-R/L-1616-2-T15
ADKT-K-R/L-2020-2-T15
ADKT-K-R/L-2525-2-T15
ADKT-K-R/L-3232-2-T15
ADKT-K-R/L-2020-3-T10
ADKT-K-R/L-1212-3-T15
ADKT-K-R/L-1616-3-T7
ADKT-K-R/L-1616-3-T15
ADKT-K-R/L-2020-3-T20

KRLY UCUNA UYGUNDUR.
COMPATIBLE WITH KRLY INSERT.

ADKT-K-R/L-2020-3-R28
ADKT-K-R/L-2525-3-T10
ADKT-K-R/L-2525-3-R15
ADKT-K-R/L-2525-3-T22
ADKT-K-R/L-2525-3-T30
ADKT-K-R/L-3232-3-T10
ADKT-K-R/L-3232-3-T22
ADKT-K-R/L-2020-4-T20
ADKT-K-R/L-2525-4-T22
ADKT-K-R/L-3232-4-T22
ADKT-K-R/L-2020-4-T10
ADKT-K-R/L-2020-5-T20
ADKT-K-R/L-2525-5-T18

ADKT-K-R/L-2525-5-T25
ADKT-K-R/L-3232-5-T25
ADKT-K-R/L-2525-6-T25
ADKT-K-R/L-3232-6-T25
ADKT-K-R/L-3232-8-T32
ADKT-K-R/L-2020-4-R25
ADKT-K-R/L-2525-4-T10
ADKT-K-R/L-2525-4-T18
ADKT-K-R/L-3232-4-T10
ADKT-K-R/L-2525-5-T15
ADKT-K-R/L-3232-5-T15
ADKT-K-R/L-2525-6-T15
ADKT-K-R/L-2525-6-T25



ADKT-K-R/L-1616-2-T10-H
ADKT-K-R/L-1616-3-T15-H
ADKT-K-R/L-2020-3-R22-H
ADKT-K-R/L-2020-3-T20-H
ADKT-K-R/L-2525-3-T22-H
ADKT-K-R/L-2020-4-T20-H
ADKT-K-R/L-2525-4-T22-H
ADKT-K-R/L-2525-5-T25-H

KRLY UCUNA UYGUNDUR.
COMPATIBLE WITH KRLY INSERT.



ADKT-K-R/L-1212-2-R12-K-S
ADKT-K-R/L-1616-2-R16-K-S
ADKT-K-R/L-1212-3-R12-K-S
ADKT-K-R/L-1616-3-R16-K-S

KRLY UCUNA UYGUNDUR.
COMPATIBLE WITH KRLY INSERT.



AAKT-K-R/L-2525-34-45-3-T17
AAKT-K-R/L-2525-39-55-3-T17
AAKT-K-R/L-2525-49-80-3-T17
AAKT-K-R/L-2525-70-110-3-T17
AAKT-K-R/L-2525-100-150-3-T17
AAKT-K-R/L-2525-80-180-3-T32
AAKT-K-R/L-2525-175-215-3-T22
AAKT-K-R/L-2525-700-800-3-T17
AAKT-K-R/L-3232-140-450-3-T17
AAKT-K-R/L-2525-50-85-4-T22
AAKT-K-R/L-2525-70-110-4-T22
AAKT-K-R/L-2525-100-150-4-T22
AAKT-K-R/L-2525-80-180-4-T32
AAKT-K-R/L-2525-180-800-4-T32
AAKT-K-R/L-2525-70-110-5-T25
AAKT-K-R/L-2525-100-150-5-T25
AAKT-K-R/L-2525-100-200-5-T45

KRLY UCUNA UYGUNDUR.
COMPATIBLE WITH KRLY INSERT.

AAKT-K-R/L-2525-80-180-5-T32
AAKT-K-R/L-2525-140-200-5-T25
AAKT-K-R/L-2525-180-800-5-T32
AAKT-K-R/L-2525-180-800-5-T40
AAKT-K-R/L-2525-60-100-6-T25
AAKT-K-R/L-2525-60-100-6-T35
AAKT-K-R/L-2525-100-200-6-T25
AAKT-K-R/L-2525-100-200-6-T35
AAKT-K-R/L-2525-100-200-6-T45
AAKT-K-R/L-2525-140-300-6-T35
AAKT-K-R/L-2525-180-360-6-T40
AAKT-K-R/L-2525-100-200-6-T25
AAKT-K-R/L-3232-140-800-6-T25
AAKT-K-R/L-3232-180-800-6-T41
AAKT-K-R/L-3232-400-500-6-T25
AAKT-K-R/L-2525-140-300-8-T35
AAKT-K-R/L-3232-140-350-8-T35



ALKT-K-R/L-2525-35-..-3-T4
ALKT-K-R/L-2525-35-45-3-T15
ALKT-K-R/L-2525-40-..-4-T4
ALKT-K-R/L-2525-40-60-4-T15

KRLY UCUNA UYGUNDUR.
COMPATIBLE WITH KRLY INSERT.



AIKT-K-R/L-16-2-T4
AIKT-K-R/L-20-2-T4
AIKT-K-R/L-25-2-T6
AIKT-K-R/L-16-3-T7
AIKT-K-R/L-20-3-T6
AIKT-K-R/L-20-3-T7
AIKT-K-R/L-25-3-T6
AIKT-K-R/L-25-3-T10

KRLY UCUNA UYGUNDUR.
COMPATIBLE WITH KRLY INSERT.

AIKT-K-R/L-32-3-T6
AIKT-K-R/L-32-3-T12
AIKT-K-R/L-40-3-T6
AIKT-K-R/L-40-3-T12
AIKT-K-R/L-20-4-T6
AIKT-K-R/L-20-4-T7
AIKT-K-R/L-25-4-T6
AIKT-K-R/L-25-4-T10

AIKT-K-R/L-32-4-T6
AIKT-K-R/L-32-4-T12
AIKT-K-R/L-40-4-T6
AIKT-K-R/L-40-4-T12
AIKT-K-R/L-25-5-T7
AIKT-K-R/L-32-5-T7
AIKT-K-R/L-40-5-T7
AIKT-K-R/L-40-5-T12

Kanal Açma Takımları / Grooving Toolholders

 <p>AKL-K-32-2 AKL-K-32-3 AKL-K-32-4</p> <p>KRLY UCUNA UYGUNDUR. COMPATIBLE WITH KRLY INSERT.</p>	 <p>ADKT-KG-R/L-1010-2-R10-K-S ADKT-KG-R/L-1212-2-R12-K-S ADKT-KG-R/L-1616-2-R16-K-S ADKT-KG-R/L-1212-3-R12-K-S ADKT-KG-R/L-1616-3-R16-K-S</p> <p>KRLY UCUNA UYGUNDUR. COMPATIBLE WITH KRLY INSERT.</p>	 <p>ADKT-KG-R/L-2020-2-T15 ADKT-KG-R/L-2525-2-T8 ADKT-KG-R/L-2525-2-T15 ADKT-KG-R/L-2525-2-T17 ADKT-KG-R/L-1616-3-T20 ADKT-KG-R/L-2020-3-T20 ADKT-KG-R/L-2525-3-T10 ADKT-KG-R/L-2525-3-T13 ADKT-KG-R/L-2525-3-T22</p> <p>KRLY UCUNA UYGUNDUR. COMPATIBLE WITH KRLY INSERT.</p>	<p>ADKT-KG-R/L-2020-4-T20 ADKT-KG-R/L-2525-4-T10 ADKT-KG-R/L-2525-4-T16 ADKT-KG-R/L-2525-4-T22 ADKT-KG-R/L-2525-5-T12 ADKT-KG-R/L-2525-5-T15 ADKT-KG-R/L-2525-5-T25 ADKT-KG-R/L-2525-6-T25</p>
 <p>AAKT-KG-R/L-2525-44-70-4-T22 AAKT-KG-R/L-2525-60-120-4-T22 AAKT-KG-R/L-2525-112-200-4-T22</p> <p>KRLY UCUNA UYGUNDUR. COMPATIBLE WITH KRLY INSERT.</p>	 <p>AIKT-KG-R/L-25-2-T7 AIKT-KG-R/L-20-3-T6.5-H AIKT-KG-R/L-25-3-T7 AIKT-KG-R/L-40-3-T8 AIKT-KG-R/L-25-4-T8</p> <p>KRLY UCUNA UYGUNDUR. COMPATIBLE WITH KRLY INSERT.</p>	 <p>AKL-SP-26-2 AKL-SP-26-3 AKL-SP-32-3 AKL-SP-32-4</p> <p>KRLY UCUNA UYGUNDUR. COMPATIBLE WITH KRLY INSERT.</p>	
 <p>ADKT-LGC-R/L-1616-2-D40 ADKT-LGC-R/L-2020-2-D40 ADKT-LGC-R/L-2525-2-D40 ADKT-LGC-R/L-1616-3-T20 ADKT-LGC-R/L-2020-3-T20 ADKT-LGC-R/L-2525-3-T20</p> <p>LMN UCUNA UYGUNDUR. COMPATIBLE WITH LMN INSERT.</p>	 <p>ADKT-GY2-R/L-2525-2-R20 ADKT-GY2-R/L-2525-2.5-R6 ADKT-GY2-R/L-2525-3-R20 ADKT-GY2-R/L-2525-4-T25 ADKT-GY2-R/L-2525-5-T25</p> <p>MTSBH UCUNA UYGUNDUR. COMPATIBLE WITH MTSBH INSERT.</p>	 <p>AKL-GW1-32-2 AKL-GW1-32-3 AKL-GW1-32-4</p> <p>MTSBH UCUNA UYGUNDUR. COMPATIBLE WITH MTSBH INSERT.</p>	
 <p>ADKT-TGF-R/L-1616-3 ADKT-TGF-R/L-2020-3 ADKT-TGF-R/L-2525-3</p> <p>NTK UCUNA UYGUNDUR. COMPATIBLE WITH NTK INSERT.</p>	 <p>ADKT-GP-R/L-2020-2-T15 ADKT-GP-R/L-2525-2-T15 ADKT-GP-R/L-2020-3-T20 ADKT-GP-R/L-2525-3-T22 ADKT-GP-R/L-2525-4-T22 ADKT-GP-R/L-2525-5-T25</p> <p>PLBT UCUNA UYGUNDUR. COMPATIBLE WITH PLBT INSERT.</p>	 <p>AIKT-GP-R/L-20-2-T4 AIKT-GP-R/L-25-2-T6 AIKT-GP-R/L-20-3-T6 AIKT-GP-R/L-25-3-T6 AIKT-GP-R/L-32-3-T6 AIKT-GP-R/L-20-4-T6 AIKT-GP-R/L-25-4-T6 AIKT-GP-R/L-32-4-T6</p> <p>PLBT UCUNA UYGUNDUR. COMPATIBLE WITH PLBT INSERT.</p>	
 <p>AIKT-LC13-R/L-16-3-T4 AIKT-LC13-R/L-16-4-T6</p> <p>SC UCUNA UYGUNDUR. COMPATIBLE WITH SC INSERT.</p>	 <p>ADKT-SGC-R/L-1212-2-R15 ADKT-SGC-R/L-1616-2-R15 ADKT-SGC-R/L-2020-2-R20 ADKT-SGC-R/L-2525-2-R20 ADKT-SGC-R/L-1212-3-R15 ADKT-SGC-R/L-1616-3-T12 ADKT-SGC-R/L-1616-3-R15 ADKT-SGC-R/L-2020-3-R22 ADKT-SGC-R/L-2525-3-T10</p> <p>SMTM UCUNA UYGUNDUR. COMPATIBLE WITH SMTM INSERT.</p>	<p>ADKT-SGC-R/L-2525-3-R15 ADKT-SGC-R/L-2525-3-R22 ADKT-SGC-R/L-2525-4-T10 ADKT-SGC-R/L-2525-4-T15 ADKT-SGC-R/L-2525-4-T20 ADKT-SGC-R/L-2525-4-R25</p>	
 <p>ADKT-SGC-R/L-2525-3-R25-H</p> <p>SMTM UCUNA UYGUNDUR. COMPATIBLE WITH SMTM INSERT.</p>	 <p>ADKT-SWC-R/L-2020-2-T25 ADKT-SWC-R/L-2020-3-T25</p> <p>SMTM UCUNA UYGUNDUR. COMPATIBLE WITH SMTM INSERT.</p>	 <p>AAKT-SGC-R/L-2020-22-53-3-T13 AAKT-SGC-R/L-2525-80-100-3-T8 AAKT-SGC-R/L-2525-40-65-4-T12 AAKT-SGC-R/L-2525-80-140-4-T8</p> <p>SMTM UCUNA UYGUNDUR. COMPATIBLE WITH SMTM INSERT.</p>	



AIKT-SGC-R/L-25-3-T6
AIKT-SGC-R/L-25-3-T12
AIKT-SGC-R/L-32-3-T6
AIKT-SGC-R/L-32-3-T12
AIKT-SGC-R/L-40-3-T6
AIKT-SGC-R/L-40-3-T12
AIKT-SGC-R/L-25-4-T6
AIKT-SGC-R/L-25-4-T12

AIKT-SGC-R/L-32-4-T6
AIKT-SGC-R/L-32-4-T12
AIKT-SGC-R/L-40-4-T6
AIKT-SGC-R/L-40-4-T12

SMTM UCUNA UYGUNDUR.
COMPATIBLE WITH SMTM INSERT.

SMTM UCUNA UYGUNDUR.
COMPATIBLE WITH SMTM INSERT.

SMTM UCUNA UYGUNDUR.
COMPATIBLE WITH SMTM INSERT.



ADKT-123-R/L-1212-1.5-R15
ADKT-123-R/L-1616-1.5-R15
ADKT-123-R/L-2012-1.5-R15
ADKT-123-R/L-1212-2-T12
ADKT-123-R/L-1616-2-T15
ADKT-123-R/L-2020-2-T8
ADKT-123-R/L-2020-2-T15
ADKT-123-R/L-2525-2-T8
ADKT-123-R/L-2525-2-T15

ADKT-123-R/L-3232-2-T15
ADKT-123-R/L-1616-2.5-R17
ADKT-123-R-1616-3-T10
ADKT-123-R/L-1616-3-T15
ADKT-123-R-2020-3-T10
ADKT-123-R-2020-3-T15
ADKT-123-R/L-2020-3-T20
ADKT-123-R-2525-3-T10
ADKT-123-R-2525-3-T15

ADKT-123-R/L-2525-3-T22
ADKT-123-R/L-2020-4-T20
ADKT-123-R-2525-4-T13
ADKT-123-R/L-2525-4-T22
ADKT-123-R/L-3232-4-T25
ADKT-123-R/L-2020-5-T20
ADKT-123-R/L-2525-5-T25
ADKT-123-R/L-3232-6-T15

SNDVK UCUNA UYGUNDUR.
COMPATIBLE WITH SNDVK INSERT.



ADKT-123-R/L-1212-2-T12-K-S
ADKT-123-R/L-1212-3-T12-K-S



AKL-123-32-2
AKL-123-32-3
AKL-123-32-4
AKL-123-32-6



AIKT-123-R/L-20-2-T6
AIKT-123-R/L-25-2-T6
AIKT-123-R/L-32-2-T7
AIKT-123-R/L-20-3-T6
AIKT-123-R/L-25-3-T7
AIKT-123-R/L-32-3-T9
AIKT-123-R/L-20-4-T8
AIKT-123-R/L-25-4-T7
AIKT-123-R/L-32-4-T7
AIKT-123-R/L-32-4-T10
AIKT-123-R/L-25-5-T8
AIKT-123-R/L-32-5-T11

SNDVK UCUNA UYGUNDUR.
COMPATIBLE WITH SNDVK INSERT.

SNDVK UCUNA UYGUNDUR.
COMPATIBLE WITH SNDVK INSERT.

SNDVK UCUNA UYGUNDUR.
COMPATIBLE WITH SNDVK INSERT.



ADKT-154-91-R/L-2020-3-T4
ADKT-154-91-R/L 2525-3-T4
ADKT-154-91-R/L 2020-5-T5
ADKT-154-91-R/L 2525-5-T5



AIKT-154.91-R/L-16-3-T3
AIKT-154.91-R/L-20-3-T4
AIKT-154.91-R/L-25-3-T4
AIKT-154.91-R/L-25-5-T5
AIKT-154.91-R/L-32-5-T5



AIKT-151.23-R/L-20-2-T6
AIKT-151.23-R/L-20-2.5-T6
AIKT-151.22-R/L-25-3-T6
AIKT-151.22-R/L-25-3-T6-H

SMTM UCUNA UYGUNDUR.
COMPATIBLE WITH SMTM INSERT.

SNDVK UCUNA UYGUNDUR.
COMPATIBLE WITH SNDVK INSERT.

SNDVK UCUNA UYGUNDUR.
COMPATIBLE WITH SNDVK INSERT.



ADKT-151.22-R/L-1616-2-T15
ADKT-151.22-R/L-2020-2-T15
ADKT-151.22-R/L-2525-2-T15
ADKT-151.22-R/L-1616-3-T15
ADKT-151.22-R/L-2020-3-T20
ADKT-151.22-R/L-2525-3-T22
ADKT-151.22-R/L-1616-4-T15
ADKT-151.22-R/L-2020-4-T20
ADKT-151.22-R/L-2525-4-T22

ADKT-151.22-R/L-2020-5-T20
ADKT-151.22-R/L-2525-5-T25
ADKT-151.23-R/L-1616-2-T15
ADKT-151.23-R/L-2020-2-T15
ADKT-151.23-R/L-2525-2-T15
ADKT-151.23-R/L-1616-2.5-T15
ADKT-151.23-R/L-2020-2.5-T15
ADKT-151.23-R/L-2525-2.5-T15
ADKT-151.23-R/L-1212-3-T15

ADKT-151.23-R/L-1616-3-T15
ADKT-151.23-R/L-2020-3-T20
ADKT-151.23-R/L-2525-3-T20
ADKT-151.23-R/L-2525-3-T22
ADKT-151.23-R/L-1616-4-T15
ADKT-151.23-R/L-2020-4-T20
ADKT-151.23-R/L-2525-4-T22
ADKT-151.23-R/L-2020-5-T20
ADKT-151.23-R/L-2525-5-T25

SNDVK UCUNA UYGUNDUR.
COMPATIBLE WITH SNDVK INSERT.



AIKT-MB07-A16-090-15
AIKT-MB07-A16-090-22
AIKT-MB09-A16-090-19
AIKT-MB09-A16-095-28
AIKT-MB09-A16-110-40



ADKT-RD-R/L-1616-2-T17
ADKT-RD-R/L-2020-2-T17
ADKT-RD-R/L-2525-2-T17
ADKT-RD-R/L-1616-3-T20
ADKT-RD-R/L-2020-3-T25
ADKT-RD-R/L-2525-3-T25
ADKT-RD-R/L-2020-4-T30
ADKT-RD-R/L-2525-4-T30



ADKT-RD-R/L-1212-2-T12-K-S
ADKT-RD-R/L-1616-2-T17-K-S
ADKT-RD-R/L-1212-3-T12-K-S
ADKT-RD-R/L-1616-3-T13-K-S

SNDVK UCUNA UYGUNDUR.
COMPATIBLE WITH SNDVK INSERT.

TGTC UCUNA UYGUNDUR.
COMPATIBLE WITH TGTC INSERT.

TGTC UCUNA UYGUNDUR.
COMPATIBLE WITH TGTC INSERT.

Kanal Açma Takımları / Grooving Toolholders



TGTC UCUNA UYGUNDUR.
COMPATIBLE WITH TGTC INSERT.

ADKT-TD-R/L-1212-2-T15
ADKT-TD-R/L-1616-2-T8
ADKT-TD-R/L-1616-2-T15
ADKT-TD-R/L-2020-2-T9
ADKT-TD-R/L-2020-2-T15
ADKT-TD-R/L-2020-2-T17
ADKT-TD-R/L-2020-2-T20
ADKT-TD-R/L-2525-2-T8

ADKT-TD-R/L-2525-2-T17
ADKT-TD-R/L-1212-3-T15
ADKT-TD-R/L-1616-3-T15
ADKT-TD-R/L-2020-3-T12
ADKT-TD-R/L-2020-3-T20
ADKT-TD-R/L-2020-3-T25
ADKT-TD-R/L-2020-3-T30
ADKT-TD-R/L-2525-3-T9

ADKT-TD-R/L-2525-3-T12
ADKT-TD-R/L-2525-3-T22
ADKT-TD-R/L-2525-3-T25
ADKT-TD-R/L-2525-3-T30
ADKT-TD-R/L-3232-3-T25
ADKT-TD-R/L-2525-4-T10
ADKT-TD-R/L-2525-4-T15
ADKT-TD-R/L-2525-4-T22

ADKT-TD-R/L-2525-4-T25
ADKT-TD-R/L-2525-4-T30
ADKT-TD-R/L-2525-5-T25



TGTC UCUNA UYGUNDUR.
COMPATIBLE WITH TGTC INSERT.

AIKT-RD-R/L-16-2-T6
AIKT-RD-R/L-20-2-T6
AIKT-RD-R/L-25-2-T6
AIKT-RD-R/L-16-3-T6
AIKT-RD-R/L-20-3-T6
AIKT-RD-R/L-25-3-T6
AIKT-RD-R/L-32-3-T6
AIKT-RD-R/L-20-4-T6

AIKT-RD-R/L-25-4-T6
AIKT-RD-R/L-32-4-T6



TGTC UCUNA UYGUNDUR.
COMPATIBLE WITH TGTC INSERT.

ADKT-TD-R/L-2020-3-T30-H



TGTC UCUNA UYGUNDUR.
COMPATIBLE WITH TGTC INSERT.

ADKT-TD-R/L-1010-2-R10-K-S
ADKT-TD-R/L-1212-2-T12-K-S
ADKT-TD-R/L-1616-2-T16-K-S
ADKT-TD-R/L-1212-3-T12-K-S
ADKT-TD-R/L-1616-3-T16-K-S



TGTC UCUNA UYGUNDUR.
COMPATIBLE WITH TGTC INSERT.

AKL-TD-32-2
AKL-TD-26-3
AKL-TD-32-3
AKL-TD-26-4
AKL-TD-32-5



TGTC UCUNA UYGUNDUR.
COMPATIBLE WITH TGTC INSERT.

AIKT-TD-R-16-2-T8.5-H
AIKT-TD-R-20-3-T6-H
AIKT-TD-R-25-3-T6-H
AIKT-TD-R-32-3-T5-H
AIKT-TD-R/L-32-3-T10-H
AIKT-TD-R/L-40-3-T12-H
AIKT-TD-R/L-20-4-T10-H
AIKT-TD-R/L-25-4-T10-H
AIKT-TD-R/L-32-4-T10-H



TNGLY UCUNA UYGUNDUR.
COMPATIBLE WITH TNGLY INSERT.

ADKT-TG-R/L-1212-2-R12-K-S
ADKT-TG-R/L-1212-3-R12-K-S



TNGLY UCUNA UYGUNDUR.
COMPATIBLE WITH TNGLY INSERT.

ADKT-TG-R/L-1616-2-R17
ADKT-TG-R/L-2020-2-T8
ADKT-TG-R/L-2020-2-R12
ADKT-TG-R/L-2020-2-R17
ADKT-TG-R/L-2525-2-R12
ADKT-TG-R/L-2525-2-R17
ADKT-TG-R/L-1616-3-T20
ADKT-TG-R/L-2020-3-T12
ADKT-TG-R/L-2020-3-T20

ADKT-TG-R/L-2525-3-T9
ADKT-TG-R/L-2525-3-T20
ADKT-TG-R/L-2525-3-R25
ADKT-TG-R/L-2525-4-T15
ADKT-TG-R/L-2525-4-T20
ADKT-TG-R/L-2525-4-T25
ADKT-TG-R/L-2525-5-T12
ADKT-TG-R/L-2525-5-T25
ADKT-TG-R/L-2525-5-T32



TNGLY UCUNA UYGUNDUR.
COMPATIBLE WITH TNGLY INSERT.

AIKT-TG-R/L-20-2-T6
AIKT-TG-R/L-20-3-T6
AIKT-TG-R/L-25-3-T8
AIKT-TG-R/L-32-3-T10
AIKT-TG-R/L-32-3-T12
AIKT-TG-R/L-32-4-T10
AIKT-TG-R/L-32-5-T10



TNGLY UCUNA UYGUNDUR.
COMPATIBLE WITH TNGLY INSERT.

AIKT-6G-R/L-08H
AIKT-7G-R/L-10K
AIKT-7G-R/L-12M
AIKT-8G-R/L-10K
AIKT-8G-R/L-12M
AIKT-9G-R/L-16R



WLTR UCUNA UYGUNDUR.
COMPATIBLE WITH WLTR INSERT.

ADKT-WGX16-R/L-2020-2-R16
ADKT-WGX16-R/L-2525-2-R16
ADKT-WGX24-R/L-2020-3-T20
ADKT-WGX24-R/L-2525-3-T12
ADKT-WGX24-R/L-2525-3-T22
ADKT-WGX24-R/L-3232-3-T22
ADKT-WGX24-R/L-2525-4-T22
ADKT-WGX24-R/L-2525-4-T25
ADKT-WGX24-R/L-2525-5-T25
ADKT-WGX24-R/L-3232-5-T25



WLTR UCUNA UYGUNDUR.
COMPATIBLE WITH WLTR INSERT.

ADKT-WGX16-R/L-1212-2-R12-K-S
ADKT-WGX16-R/L-1616-2-R16-K-S
ADKT-WGX24-R/L-1616-3-R16-K-S

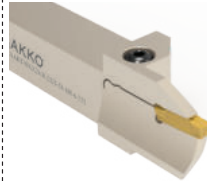

WLTR UCUNA UYGUNDUR.
COMPATIBLE WITH WLTR INSERT.

AAKT-WGX24-R-L-2525-58-100-6-T32
AAKT-WGX24-R-L-2525-88-180-6-T32



WLTR UCUNA UYGUNDUR.
COMPATIBLE WITH WLTR INSERT.

AKL-SX-32-3
AKL-SX-32-4
AKL-SX-32-5
AKL-SX-32-6



ADKT-GB-R/L-1212-3
ADKT-GB-R/L-1616-3
ADKT-GB-R/L-2020-3

XTC-GSC UCUNA UYGUNDUR.
COMPATIBLE WITH
XTC-GSC INSERT.



ADKT-ZCC2-R/L-1616-2-T15
ADKT-ZCC2-R/L-2020-2-T7
ADKT-ZCC2-R/L-2020-2-T15
ADKT-ZCC2-R/L-2525-2-T15
ADKT-ZCC2-R/L-1616-2.5-T15
ADKT-ZCC2-R/L-2020-2.5-T17
ADKT-ZCC2-R/L-2525-2.5-T15
ADKT-ZCC2-R/L-1616-3-T15
ADKT-ZCC2-R/L-1616-3-T17
ADKT-ZCC2-R/L-1616-3-T20
ADKT-ZCC2-R/L-2020-3-T12
ADKT-ZCC2-R/L-2020-3-T20
ADKT-ZCC2-R/L-2020-3-R21
ADKT-ZCC2-R/L-2020-3-R25
ADKT-ZCC2-R/L-2525-3-T12
ADKT-ZCC2-R/L-2525-3-T22
ADKT-ZCC2-R/L-2525-3-R30
ADKT-ZCC2-R/L-2020-4-T12
ADKT-ZCC2-R/L-2020-4-T20
ADKT-ZCC2-R/L-2525-4-T12
ADKT-ZCC2-R/L-2525-4-T22
ADKT-ZCC2-R/L-2525-4-T25
ADKT-ZCC2-R/L-2020-5-T12
ADKT-ZCC2-R/L-2020-5-T20
ADKT-ZCC2-R/L-2525-5-T12
ADKT-ZCC2-R/L-2525-5-T25
ADKT-ZCC2-R/L-3232-5-T25
ADKT-ZCC2-R/L-2020-6-T20
ADKT-ZCC2-R/L-2525-6-T25
ADKT-ZCC2-R/L-3232-6-T25
ADKT-ZCC2-R/L-3232-6-T30

ZCC UCUNA UYGUNDUR.
COMPATIBLE WITH ZCC INSERT.



AAKT-ZCC2-R/L-2525-140-180-2-T4
AAKT-ZCC2-R/L-2525-35-45-3-T17
AAKT-ZCC2-R/L-2525-39-55-3-T17
AAKT-ZCC2-R/L-2525-49-80-3-T17
AAKT-ZCC2-R/L-2525-70-110-3-T15
AAKT-ZCC2-R/L-2525-70-110-3-T17
AAKT-ZCC2-R/L-2525-100-150-3-T17
AAKT-ZCC2-R/L-2525-100-150-3-T22
AAKT-ZCC2-R/L-3232-135-175-3-T5
AAKT-ZCC2-R/L-3232-145-175-3-T15

ZCC UCUNA UYGUNDUR.
COMPATIBLE WITH ZCC INSERT.

AAKT-ZCC2-R/L-3232-155-185-3-T7
AAKT-ZCC2-R/L-3232-180-215-3-T5
AAKT-ZCC2-R/L-2525-40-60-4-T22
AAKT-ZCC2-R/L-2525-52-80-4-T22
AAKT-ZCC2-R/L-2525-72-110-4-T22
AAKT-ZCC2-R/L-2525-100-150-4-T22
AAKT-ZCC2-R/L-2525-140-200-4-T22
AAKT-ZCC2-R/L-3232-130-195-4-T10
AAKT-ZCC2-R/L-2525-55-95-5-T25
AAKT-ZCC2-R/L-2525-85-140-5-T25

AAKT-ZCC2-R/L-2525-100-200-5-T45
AAKT-ZCC2-R/L-2525-130-200-5-T25
AAKT-ZCC2-R/L-2525-190-400-5-T25
AAKT-ZCC2-R/L-2525-190-400-5-T35
AAKT-ZCC2-R/L-3232-150-215-5-T10
AAKT-ZCC2-R/L-2525-200-500-5-T17
AAKT-ZCC2-R/L-2525-60-110-6-T15
AAKT-ZCC2-R/L-3232-160-400-6-T25



ADKT-ZCC1-R/L-2020-3-T20
ADKT-ZCC1-R/L-2525-3-T22
ADKT-ZCC1-R/L-2020-4-T20
ADKT-ZCC1-R/L-2525-4-T22

ZCC UCUNA UYGUNDUR.
COMPATIBLE WITH ZCC INSERT.



ADKT-ZCC2-R/L-1010-2-T12-K-S
ADKT-ZCC2-R/L-1212-2-T12-K-S
ADKT-ZCC2-R/L-1616-2-R16-K-S
ADKT-ZCC2-R/L-1212-3-T12-K-S

ZCC UCUNA UYGUNDUR.
COMPATIBLE WITH ZCC INSERT.



ALKT-ZCC2-R/L-2525-35-45-3-T10
ALKT-ZCC2-R/L-2525-39-55-3-T10
ALKT-ZCC2-R/L-2525-35- \varnothing -3-T4
ALKT-ZCC2-R/L-2525-40-60-4-T14
ALKT-ZCC2-R/L-2525-52-80-4-T14
ALKT-ZCC2-R/L-2525-72-110-4-T14
ALKT-ZCC2-R/L-2525-100-230-4-T14
ALKT-ZCC2-R/L-2525-40- \varnothing -4-T4

ZCC UCUNA UYGUNDUR.
COMPATIBLE WITH ZCC INSERT.



AIKT-ZCC2-R/L-16-2-T4
AIKT-ZCC2-R/L-20-3-T5
AIKT-ZCC2-R/L-20-3-T8
AIKT-ZCC2-R/L-25-3-T5
AIKT-ZCC2-R/L-25-3-T10
AIKT-ZCC2-R/L-32-3-T6
AIKT-ZCC2-R/L-32-3-T8
AIKT-ZCC2-R/L-32-3-T13
AIKT-ZCC2-R/L-40-3-T12
AIKT-ZCC2-R/L-25-4-T6
AIKT-ZCC2-R/L-32-4-T7
AIKT-ZCC2-R/L-32-4-T8
AIKT-ZCC2-R/L-32-4-T10
new AIKT-ZCC2-R/L-25-5-T7
AIKT-ZCC2-R/L-32-5-T17
AIKT-ZCC2-R/L-32-5-T8
AIKT-ZCC2-R/L-40-5-T8
AIKT-ZCC2-R/L-40-5-T10

ZCC UCUNA UYGUNDUR.
COMPATIBLE WITH ZCC INSERT.



AKL-ZCC2-32-3
AKL-ZCC2-32-4
AKL-ZCC2-32-5

ZCC UCUNA UYGUNDUR.
COMPATIBLE WITH ZCC INSERT.



AIKT-QC11-R/L-20-(0.5-1.8)
AIKT-QC16-R/L-20-(0.5-1.8)
AIKT-QC16-R/L-20-(0.5-2.5)
AIKT-QC22-R/L-25-(1-2.3)
AIKT-QC22-R/L-25-(2.5-3.3)
AIKT-QC22-R/L-25-(3.3-4.8)
AIKT-QC22-R/L-32-(1-2.3)

ZCC UCUNA UYGUNDUR.
COMPATIBLE WITH ZCC INSERT.



Delik Delme Uçları (SPMX - WCMX) / Drilling Inserts (SPMX - WCMX)

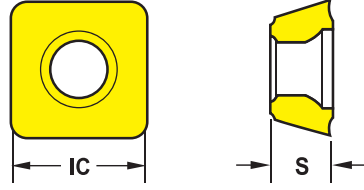

	IC	S
Metric	5	2.38
Inch	0.197	0.094
Metric	6	2.41
Inch	0.236	0.094
Metric	7.94	3.97
Inch	0.313	0.156
Metric	9.8	4.3
Inch	0.386	0.169
Metric	11.5	4.8
Inch	0.453	0.189
Metric	14.3	5.2
Inch	0.563	0.205

ISO 4 Corner / 4 Köşeli
SPMX Series / Serileri
00, 01, 02, 03, 04, 05



EDP	DESCRIPTION / AÇIKLAMA	FEED RATE / İLERLEME	
T.01.07.02.00	SPMX050204-VG3002	mm/rev.	0.07~0.14
		Inch/rev.	.003~.006
T.01.07.02.01	SPMX060204-VG3002	mm/rev.	0.08~0.14
		Inch/rev.	.003~.006
T.01.07.02.02	SPMX07T308-VG3002	mm/rev.	0.08~0.16
		Inch/rev.	.003~.006
T.01.07.02.03	SPMX090408-VG3002	mm/rev.	0.08~0.16
		Inch/rev.	.003~.006
T.01.07.02.04	SPMX110408-VG3002	mm/rev.	0.10~0.18
		Inch/rev.	.004~.007
T.01.07.02.05	SPMX140512-VG3002	mm/rev.	0.10~0.20
		Inch/rev.	.004~.008

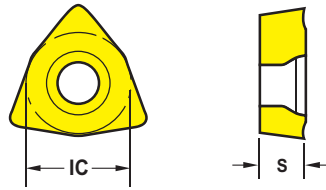

	IC	S
Metric	5.56	2.38
Inch	0.219	0.094
Metric	6.35	2.38
Inch	0.236	0.094
Metric	7.94	3.18
Inch	0.313	0.125
Metric	9.53	3.97
Inch	0.375	0.156
Metric	12.7	4.76
Inch	0.500	0.187

ISO 3 Corner / 3 Köşeli
WCMX Series / Serileri
01, 02, 03, 04, 05



EDP	DESCRIPTION / AÇIKLAMA	FEED RATE / İLERLEME	
T.01.07.01.01	WCMX030208-VG3002	mm/rev.	0.05~0.12
		Inch/rev.	.002~.005
T.01.07.01.02	WCMX040208-VG3002	mm/rev.	0.05~0.12
		Inch/rev.	.002~.005
T.01.07.01.03	WCMX050308-VG3002	mm/rev.	0.06~0.14
		Inch/rev.	.002~.006
T.01.07.01.04	WCMX06T308-VG3002	mm/rev.	0.08~0.14
		Inch/rev.	.003~.006
T.01.07.01.05	WCMX080412-VG3002	mm/rev.	0.08~0.14
		Inch/rev.	.003~.006

Cutting Speed / Kesme Hızı			Vc (ft/min)	
ISO	VDI	Sub Group / Alt Grup	VG3002	
			Min	Max
P	1~5	Non-Alloyed Steel / Alaşimsız Çelik	460	1250
	6~9	Low-Alloyed Steel / Düşük Alaşımli Çelik	390	980
	10~11	High-Alloyed Steel / Yüksek Alaşımli Çelik	230	490
M	12~13	Ferritic & Martensitic / Ferritik Ve Martenzitik	390	660
	14	Austenitic Stainless Steel / Östenitik Paslanmaz Çelik	430	820
K	15~16	Grey Cast Iron / Gri Dökme Demir	390	820
	17~18	Nodular Cast Iron / Sferö Döküm Demir	430	720

Delik Pahlama Bileziği / Drill Chamfering Ring Tools

ADCR

Takım Kodu / Tool Code

ADCR-120-VB1103
ADCR-125-VB1103
ADCR-130-VB1103
ADCR-135-VB1103
ADCR-140-VB1103
ADCR-145-VB1103
ADCR-150-VB1103
ADCR-155-VB1103
ADCR-160-VB1103
ADCR-165-VB1103
ADCR-170-VB1103
ADCR-175-VB1103
ADCR-180-VB1103
ADCR-185-VB1103
ADCR-190-VB1103
ADCR-195-VB1103
ADCR-200-VB1103
ADCR-205-VB1103
ADCR-210-VB1103
ADCR-215-VB1103
ADCR-220-VB1103
ADCR-225-VB1103
ADCR-230-VB1103
ADCR-235-VB1103
ADCR-240-VB1103
ADCR-245-VB1103
ADCR-250-VB1103
ADCR-255-VB1103
ADCR-260-VB1103
ADCR-265-VB1103
ADCR-270-VB1103
ADCR-275-VB1103
ADCR-280-VB1103
ADCR-285-VB1103
ADCR-290-VB1103
ADCR-295-VB1103
ADCR-300-VB1103



ISO UCUNA UYGUNDUR.
COMPATIBLE WITH ISO INSERT.

Takma Uçlu Matkaplar / U-Drill System

D2

WCMX - (AKKO)
WCM - (ISO)



ATUM 16XD2 WCM. 030208
ATUM 16.5XD2 WCM. 030208
ATUM 17XD2 WCM. 030208
ATUM 17.5XD2 WCM. 030208
ATUM 18XD2 WCM. 030208
ATUM 18.5XD2 WCM. 030208
ATUM 19XD2 WCM. 030208
ATUM 19.5XD2 WCM. 030208
ATUM 20XD2 WCM. 040208
ATUM 20.5XD2 WCM. 040208
ATUM 21XD2 WCM. 040208
ATUM 21.5XD2 WCM. 040208
ATUM 22XD2 WCM. 040208
ATUM 22.5XD2 WCM. 040208
ATUM 23XD2 WCM. 040208
ATUM 23.5XD2 WCM. 040208
ATUM 24XD2 WCM. 050308
ATUM 24.5XD2 WCM. 050308
ATUM 25XD2 WCM. 050308
ATUM 25.5XD2 WCM. 050308
ATUM 26XD2 WCM. 050308
ATUM 26.5XD2 WCM. 050308
ATUM 27XD2 WCM. 050308
ATUM 27.5XD2 WCM. 050308
ATUM 28XD2 WCM. 050308
ATUM 28.5XD2 WCM. 050308
ATUM 29XD2 WCM. 050308
ATUM 29.5XD2 WCM. 050308
ATUM 30XD2 WCM. 06T308
ATUM 30.5XD2 WCM. 06T308
ATUM 31XD2 WCM. 06T308
ATUM 32XD2 WCM. 06T308
ATUM 33XD2 WCM. 06T308
ATUM 34XD2 WCM. 06T308
ATUM 35XD2 WCM. 06T308
ATUM 36XD2 WCM. 06T308
ATUM 37XD2 WCM. 06T308
ATUM 38XD2 WCM. 06T308
ATUM 39XD2 WCM. 06T308
ATUM 40XD2 WCM. 06T308
ATUM 41XD2 WCM. 06T308
ATUM 42XD2 WCM. 06T308
ATUM 43XD2 WCM. 06T308
ATUM 44XD2 WCM. 06T308
ATUM 45XD2 WCM. 080412
ATUM 46XD2 WCM. 080412
ATUM 47XD2 WCM. 080412
ATUM 48XD2 WCM. 080412
ATUM 49XD2 WCM. 080412
ATUM 50XD2 WCM. 080412
ATUM 51XD2 WCM. 080412
ATUM 52XD2 WCM. 080412
ATUM 53XD2 WCM. 080412
ATUM 54XD2 WCM. 080412
ATUM 55XD2 WCM. 080412
ATUM 56XD2 WCM. 080412
ATUM 57XD2 WCM. 080412
ATUM 58XD2 WCM. 080412
ATUM 59XD2 WCM. 080412
ATUM 60XD2 WCM. 080412

Eksantrik U-Drill Adaptörü / Excentric Adaptor For U-Drills



AET-2025
AET-2532
AET-3240

Ø+0.4 - Ø-0.2 ARASINDA
ONDALIKLI OLARAK AYARLANABİLİR
ÖR: Ø25 TAKIM = 24.8 ≈ 25.4 ARASI AYARLANABİLİR.

CAN BE ADJUSTABLE BETWEEN
Ø+0.4 - Ø-0.2 AS DECIMAL.
FOR EXAMPLE: Ø25 TOOL;
CAN BE ADJUSTABLE BETWEEN 24,8 ≈ 25,4

AET

HELİSEL İÇTEN SU VERME KANALLI MATKAPLAR
INDEXABLE DRILLS WITH HELICAL COOLANT HOLE

Farklı çaplarda ve ALFA KAPLAMA teknolojisi ile siparişe hazır.
They are ready to order in different diameters and with ALPHA COATING technology.

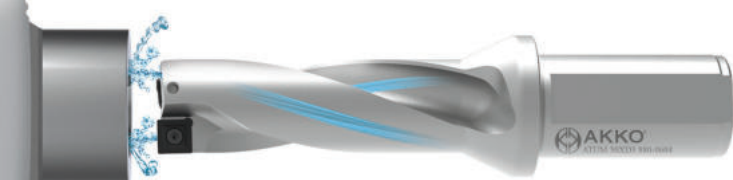

- Helisel içten su verme kanallı
- Üstün Alpha Kaplama Teknolojisi
- 1000 Vickers'e dayanan yüksek yüzey sertliği
- Aşınmaya karşı yüksek direnç
- Dengeli ve hassas kesim
- Helical Internal Coolant Holes
- Superior Alpha Coating Technology
- High surface hardness up to 1000 Vickers
- High resistance to abrasion
- Balanced and precise cutting

ISO UCUNA UYGUNDUR.
COMPATIBLE WITH ISO INSERT.

Delik Delme ve İşleme Takımları / Drilling and Holemaking Tools

Takma Uçlu Matkaplar / U-Drill System

D3 WCMX - (AKKO)
WCM - (ISO)



ATUM 16XD3 WCM. 030208
ATUM 16.5XD3 WCM. 030208
ATUM 17XD3 WCM. 030208
ATUM 17.5XD3 WCM. 030208
ATUM 18XD3 WCM. 030208
ATUM 18.5XD3 WCM. 030208
ATUM 19XD3 WCM. 030208
ATUM 19.5XD3 WCM. 030208
ATUM 20XD3 WCM. 040208
ATUM 20.5XD3 WCM. 040208
ATUM 21XD3 WCM. 040208
ATUM 21.5XD3 WCM. 040208
ATUM 22XD3 WCM. 040208
ATUM 22.5XD3 WCM. 040208
ATUM 23XD3 WCM. 040208
ATUM 23.5XD3 WCM. 040208
ATUM 24XD3 WCM. 050308
ATUM 24.5XD3 WCM. 050308
ATUM 25XD3 WCM. 050308
ATUM 25.5XD3 WCM. 050308
ATUM 26XD3 WCM. 050308
ATUM 26.5XD3 WCM. 050308
ATUM 27XD3 WCM. 050308
ATUM 27.5XD3 WCM. 050308
ATUM 28XD3 WCM. 050308
ATUM 28.5XD3 WCM. 050308
ATUM 29XD3 WCM. 050308

ATUM 29.5XD3 WCM. 050308
ATUM 30XD3 WCM. 06T308
ATUM 30.5XD3 WCM. 06T308
ATUM 31XD3 WCM. 06T308
ATUM 31.5XD3 WCM. 06T308
ATUM 32XD3 WCM. 06T308
ATUM 32.5XD3 WCM. 06T308
ATUM 33XD3 WCM. 06T308
ATUM 33.5XD3 WCM. 06T308
ATUM 34XD3 WCM. 06T308
ATUM 34.5XD3 WCM. 06T308
ATUM 35XD3 WCM. 06T308
ATUM 35.5XD3 WCM. 06T308
ATUM 36XD3 WCM. 06T308
ATUM 36.5XD3 WCM. 06T308
ATUM 37XD3 WCM. 06T308
ATUM 37.5XD3 WCM. 06T308
ATUM 38XD3 WCM. 06T308
ATUM 38.5XD3 WCM. 06T308
ATUM 39XD3 WCM. 06T308
ATUM 39.5XD3 WCM. 06T308
ATUM 40XD3 WCM. 06T308
ATUM 40.5XD3 WCM. 06T308
ATUM 41XD3 WCM. 06T308
ATUM 41.5XD3 WCM. 06T308
ATUM 42XD3 WCM. 06T308
ATUM 42.5XD3 WCM. 06T308
ATUM 43XD3 WCM. 06T308
ATUM 43.5XD3 WCM. 06T308
ATUM 44XD3 WCM. 06T308
ATUM 44.5XD3 WCM. 06T308
ATUM 45XD3 WCM. 080412
ATUM 45.5XD3 WCM. 080412
ATUM 46XD3 WCM. 080412
ATUM 47XD3 WCM. 080412
ATUM 48XD3 WCM. 080412
ATUM 49XD3 WCM. 080412
ATUM 50XD3 WCM. 080412
ATUM 51XD3 WCM. 080412
ATUM 52XD3 WCM. 080412
ATUM 53XD3 WCM. 080412
ATUM 54XD3 WCM. 080412
ATUM 55XD3 WCM. 080412
ATUM 56XD3 WCM. 080412
ATUM 57XD3 WCM. 080412
ATUM 58XD3 WCM. 080412
ATUM 59XD3 WCM. 080412
ATUM 60XD3 WCM. 080412

ISO UCUNA UYGUNDUR.
COMPATIBLE WITH ISO INSERT.

D4 WCMX - (AKKO)
WCM - (ISO)



ATUM 16XD4 WCM. 030208
ATUM 16.5XD4 WCM. 030208
ATUM 17XD4 WCM. 030208
ATUM 17.5XD4 WCM. 030208
ATUM 18XD4 WCM. 030208
ATUM 18.5XD4 WCM. 030208
ATUM 19XD4 WCM. 030208
ATUM 19.5XD4 WCM. 030208
ATUM 20XD4 WCM. 040208
ATUM 20.5XD4 WCM. 040208
ATUM 21XD4 WCM. 040208
ATUM 21.5XD4 WCM. 040208
ATUM 22XD4 WCM. 040208
ATUM 22.5XD4 WCM. 040208
ATUM 23XD4 WCM. 040208
ATUM 23.5XD4 WCM. 040208
ATUM 24XD4 WCM. 050308
ATUM 24.5XD4 WCM. 050308
ATUM 25XD4 WCM. 050308
ATUM 25.5XD4 WCM. 050308
ATUM 26XD4 WCM. 050308
ATUM 26.5XD4 WCM. 050308
ATUM 27XD4 WCM. 050308
ATUM 27.5XD4 WCM. 050308
ATUM 28XD4 WCM. 050308
ATUM 28.5XD4 WCM. 050308
ATUM 29XD4 WCM. 050308
ATUM 29.5XD4 WCM. 050308
ATUM 30XD4 WCM. 06T308
ATUM 31XD4 WCM. 06T308
ATUM 32XD4 WCM. 06T308
ATUM 33XD4 WCM. 06T308
ATUM 33.5XD4 WCM. 06T308
ATUM 34XD4 WCM. 06T308
ATUM 35XD4 WCM. 06T308
ATUM 36XD4 WCM. 06T308
ATUM 37XD4 WCM. 06T308
ATUM 38XD4 WCM. 06T308
ATUM 38.5XD4 WCM. 06T308
ATUM 39XD4 WCM. 06T308
ATUM 40XD4 WCM. 06T308
ATUM 41XD4 WCM. 06T308
ATUM 42XD4 WCM. 06T308
ATUM 43XD4 WCM. 06T308
ATUM 44XD4 WCM. 06T308
ATUM 45XD4 WCM. 080412
ATUM 46XD4 WCM. 080412
ATUM 47XD4 WCM. 080412
ATUM 48XD4 WCM. 080412
ATUM 49XD4 WCM. 080412
ATUM 50XD4 WCM. 080412

ISO UCUNA UYGUNDUR.
COMPATIBLE WITH ISO INSERT.

Takma Uçlu Matkaplar / U-Drill System

D5 WCMX - (AKKO)
WCM - (ISO)



ATUM 20XD5 WCM. 040208
ATUM 21XD5 WCM. 040208
ATUM 22XD5 WCM. 040208
ATUM 23XD5 WCM. 040208
ATUM 24XD5 WCM. 050308
ATUM 25XD5 WCM. 050308
ATUM 26XD5 WCM. 050308
ATUM 27XD5 WCM. 050308
ATUM 28XD5 WCM. 050308
ATUM 29XD5 WCM. 050308
ATUM 30XD5 WCM. 06T308
new ATUM 30.5XD5 WCM. 06T308
ATUM 31XD5 WCM. 06T308
ATUM 32XD5 WCM. 06T308
ATUM 33XD5 WCM. 06T308
ATUM 34XD5 WCM. 06T308
ATUM 35XD5 WCM. 06T308
ATUM 37XD5 WCM. 06T308
ATUM 38XD5 WCM. 06T308
ATUM 46XD5 WCM. 080412
ATUM 49XD5 WCM. 080412

ISO UCUNA UYGUNDUR.
COMPATIBLE WITH ISO INSERT.

D3 SO..
SOMX-SOMT
(ISCR)



ATUM 14XD3 SO.. 050204
ATUM 15XD3 SO.. 050204
ATUM 16XD3 SO.. 050204
ATUM 16.5XD3 SO.. 050204
ATUM 17XD3 SO.. 050204
ATUM 17.5XD3 SO.. 050204
ATUM 18XD3 SO.. 060304
ATUM 19XD3 SO.. 060304
ATUM 20XD3 SO.. 060304
ATUM 21XD3 SO.. 070305
ATUM 22XD3 SO.. 070305
ATUM 22.5XD3 SO.. 070305
ATUM 23XD3 SO.. 070305
ATUM 24XD3 SO.. 070305
ATUM 25XD3 SO.. 09T306
ATUM 26XD3 SO.. 09T306
ATUM 27XD3 SO.. 09T306
ATUM 29XD3 SO.. 09T306
ATUM 30XD3 SO.. 09T306
ATUM 31XD3 SO.. 09T306
ATUM 33XD3 SO.. 09T306
ATUM 35XD3 SO.. 120408
ATUM 36XD3 SO.. 120408
ATUM 37XD3 SO.. 120408
ATUM 38XD3 SO.. 120408
ATUM 39XD3 SO.. 120408
ATUM 40XD3 SO.. 120408
ATUM 43XD3 SO.. 120408

ISCR UCUNA UYGUNDUR.
COMPATIBLE WITH ISCR INSERT.

D4 SO.. - SOMX-SOMT (ISCR)



ATUM 14XD4 SO.. 050204
ATUM 14.5XD4 SO.. 050204
ATUM 15XD4 SO.. 050204
ATUM 15.5XD4 SO.. 050204
ATUM 17XD4 SO.. 050204
ATUM 19XD4 SO.. 060304
ATUM 19.5XD4 SO.. 060304
ATUM 20XD4 SO.. 060304
ATUM 21XD4 SO.. 070305
ATUM 22XD4 SO.. 070305
ATUM 23XD4 SO.. 070305
ATUM 24XD4 SO.. 070305
ATUM 25XD4 SO.. 09T306
ATUM 27XD4 SO.. 09T306
ATUM 28XD4 SO.. 09T306
ATUM 29XD4 SO.. 09T306
ATUM 30XD4 SO.. 09T306
ATUM 31XD4 SO.. 09T306
ATUM 33XD4 SO.. 09T306
ATUM 34XD4 SO.. 09T306
ATUM 35XD4 SO.. 120408

ISCR UCUNA UYGUNDUR.
COMPATIBLE WITH ISCR INSERT.

D2 KDR - SPMT-XOMT (KRLY)



ATUM 14XD2 KDR 0502..
ATUM 18XD2 KDR 0602..
ATUM 20XD2 KDR 07T2..
ATUM 22XD2 KDR 07T2..
ATUM 24XD2 KDR 0903..
ATUM 25XD2 KDR 0903..
ATUM 26XD2 KDR 0903..
ATUM 28XD2 KDR 0903..
ATUM 30XD2 KDR 11T3..
ATUM 32XD2 KDR 11T3..
ATUM 34XD2 KDR 11T3..
ATUM 36XD2 KDR 1304..
ATUM 37XD2 KDR 1304..
ATUM 38XD2 KDR 1304..

KRLY UCUNA UYGUNDUR.
COMPATIBLE WITH KRLY INSERT.

D4 KDR - SPMT-XOMT (KRLY)



ATUM 14XD4 KDR 0502..
ATUM 14.5XD4 KDR 0502..
ATUM 15XD4 KDR 0502..
ATUM 15.5XD4 KDR 0502..
ATUM 16XD4 KDR 0502..
ATUM 17XD4 KDR 0602..
ATUM 17.5XD4 KDR 0602..
ATUM 18XD4 KDR 0602..
ATUM 18.5XD4 KDR 0602..
ATUM 19XD4 KDR 0602..
ATUM 20XD4 KDR 07T2..
ATUM 21XD4 KDR 07T2..
ATUM 22XD4 KDR 07T2..
ATUM 24XD4 KDR 0903..
ATUM 25XD4 KDR 0903..

KRLY UCUNA UYGUNDUR.
COMPATIBLE WITH
KRLY INSERT.

D3 KDR - SPMT-
XOMT (KRLY)



ATUM 12.5XD3 KDR 0402..
ATUM 13XD3 KDR 0402..
ATUM 14XD3 KDR 0502..
ATUM 14.5XD3 KDR 0502..
ATUM 15XD3 KDR 0502..
ATUM 15.5XD3 KDR 0502..
ATUM 16XD3 KDR 0502..
ATUM 16.5XD3 KDR 0602..
ATUM 17XD3 KDR 0602..
ATUM 17.5XD3 KDR 0602..
ATUM 18XD3 KDR 0602..
ATUM 18.5XD3 KDR 0602..
ATUM 19XD3 KDR 0602..
ATUM 19.5XD3 KDR 0602..
ATUM 20XD3 KDR 07T2..
ATUM 21XD3 KDR 07T2..
ATUM 22XD3 KDR 07T2..
ATUM 22.5XD3 KDR 07T2..
ATUM 23XD3 KDR 07T2..
ATUM 23.5XD3 KDR 07T2..
ATUM 24XD3 KDR 0903..
ATUM 24.5XD3 KDR 0903..
ATUM 25XD3 KDR 0903..
ATUM 26XD3 KDR 0903..
ATUM 27XD3 KDR 0903..
ATUM 28XD3 KDR 0903..
ATUM 29XD3 KDR 0903..
ATUM 30XD3 KDR 11T3..
ATUM 32XD3 KDR 11T3..
ATUM 33XD3 KDR 11T3..
ATUM 34XD3 KDR 11T3..
ATUM 35XD3 KDR 11T3..
ATUM 37XD3 KDR 1304..
ATUM 38XD3 KDR 1304..
ATUM 39XD3 KDR 1304..
ATUM 40XD3 KDR 1304..

KRLY UCUNA UYGUNDUR.
COMPATIBLE WITH KRLY INSERT.

Delik Delme ve İşleme Takımları / Drilling and Holemaking Tools

Takma Uçlu Matkaplar / U-Drill System

D5 KDR.. - KRLY



ATUM 17XD5 KDR 0602..
ATUM 17.5XD5 KDR 0602..
ATUM 22XD5 KDR 07T2..
ATUM 30XD5 KDR 11T3..

KRLY UCUNA UYGUNDUR.
COMPATIBLE WITH KRLY INSERT.

D2 SO.. - MTSBH



ATUM 14XD2 SO.. 052704
ATUM 15XD2 SO.. 052704
ATUM 16XD2 SO.. 052704
ATUM 17XD2 SO.. 063005
ATUM 18XD2 SO.. 063005
ATUM 19XD2 SO.. 063005
ATUM 20XD2 SO.. 073505
ATUM 21XD2 SO.. 073505
ATUM 22XD2 SO.. 073505
ATUM 23XD2 SO.. 084005

ATUM 24XD2 SO.. 084005
ATUM 25XD2 SO.. 084005
ATUM 26XD2 SO.. 084005
ATUM 28XD2 SO.. 094506
ATUM 30XD2 SO.. 094506
ATUM 48XD2 SO.. 166508
ATUM 55XD2 SO.. 166508

MTSBH UCUNA UYGUNDUR.
COMPATIBLE WITH MTSBH INSERT.

D3 SO.. - MTSBH



ATUM 14XD3 SO.. 052704	ATUM 24XD3 SO.. 084005
ATUM 14.5XD3 SO.. 052704	ATUM 24.5XD3 SO.. 084005
ATUM 15XD3 SO.. 052704	ATUM 25XD3 SO.. 084005
ATUM 15.5XD3 SO.. 052704	ATUM 26XD3 SO.. 084005
ATUM 16XD3 SO.. 052704	ATUM 27XD3 SO.. 084005
ATUM 16.5XD3 SO.. 052704	ATUM 28XD3 SO.. 094506
ATUM 17XD3 SO.. 063005	ATUM 29XD3 SO.. 094506
ATUM 17.5XD3 SO.. 063005	ATUM 30XD3 SO.. 094506
ATUM 18XD3 SO.. 063005	ATUM 32XD3 SO.. 094506
ATUM 18.5XD3 SO.. 063005	
ATUM 19XD3 SO.. 063005	
ATUM 19.5XD3 SO.. 063005	
ATUM 20XD3 SO.. 073505	
ATUM 20.5XD3 SO.. 073505	
ATUM 21XD3 SO.. 073505	
ATUM 21.5XD3 SO.. 073505	
ATUM 22XD3 SO.. 073505	
ATUM 22.5XD3 SO.. 073505	
ATUM 23XD3 SO.. 084005	
ATUM 23.5XD3 SO.. 084005	

MTSBH UCUNA UYGUNDUR.
COMPATIBLE WITH MTSBH INSERT.

D3 880.. - (SNDVK)



ATUM 14XD3 880-0202..	ATUM 25XD3 880-0503..
ATUM 14.5XD3 880-0202..	ATUM 26XD3 880-0503..
ATUM 15XD3 880-0202..	ATUM 27XD3 880-0503..
ATUM 15.5XD3 880-0202..	ATUM 28XD3 880-0503..
ATUM 16XD3 880-0202..	ATUM 29XD3 880-0503..
ATUM 16.5XD3 880-0303..	ATUM 30XD3 880-0604..
ATUM 17XD3 880-0303..	ATUM 31XD3 880-0604..
ATUM 17.5XD3 880-0303..	ATUM 32XD3 880-0604..
ATUM 18XD3 880-0303..	ATUM 33XD3 880-0604..
ATUM 18.5XD3 880-0303..	ATUM 34XD3 880-0604..
ATUM 19XD3 880-0303..	ATUM 35XD3 880-0604..
ATUM 19.5XD3 880-0303..	ATUM 36XD3 880-0704..
ATUM 20XD3 880-0403..	ATUM 38XD3 880-0704..
ATUM 20.5XD3 880-0403..	ATUM 39XD3 880-0704..
ATUM 21XD3 880-0403..	ATUM 40XD3 880-0704..
ATUM 21.5XD3 880-0403..	ATUM 41XD3 880-0704..
ATUM 22XD3 880-0403..	ATUM 42XD3 880-0704..
ATUM 22.5XD3 880-0403..	ATUM 45XD3 880-0805..
ATUM 23XD3 880-0403..	ATUM 46XD3 880-0805..
ATUM 23.5XD3 880-0403..	ATUM 48XD3 880-0805..
ATUM 24XD3 880-0503..	ATUM 50XD3 880-0805..

SNDVK UCUNA UYGUNDUR.
COMPATIBLE WITH SNDVK INSERT.

D4 SO.. - MTSBH



ATUM 14XD4 SO.. 052704
ATUM 15XD4 SO.. 052704
ATUM 16XD4 SO.. 052704
ATUM 17XD4 SO.. 063005
ATUM 18XD4 SO.. 063005
ATUM 19XD4 SO.. 063005
ATUM 20XD4 SO.. 073505
ATUM 21XD4 SO.. 073505
ATUM 22XD4 SO.. 073505
ATUM 23XD4 SO.. 084005
ATUM 24XD4 SO.. 084005
ATUM 25XD4 SO.. 084005
ATUM 26XD4 SO.. 084005
ATUM 28XD4 SO.. 094506
ATUM 30XD4 SO.. 094506

MTSBH UCUNA UYGUNDUR.
COMPATIBLE WITH MTSBH INSERT.

D4 C6 880.. - SNDVK



ATUM 41XD4 C6 880-0704

SNDVK UCUNA UYGUNDUR.
COMPATIBLE WITH SNDVK INSERT.

D4 880.. - SNDVK



new ATUM 16XD2 880-0202..
new ATUM 22.5XD2 880-0403..
ATUM 25.5XD2 880-0503..
ATUM 28.5XD2 880-0503..
ATUM 32XD2 880-0604..
ATUM 35XD2 880-0604..

SNDVK UCUNA UYGUNDUR.
COMPATIBLE WITH SNDVK INSERT.

D5 880.. - SNDVK



ATUM 17.5XD5 880-0303..

SNDVK UCUNA UYGUNDUR.
COMPATIBLE WITH SNDVK INSERT.

Takma Uçlu Matkaplar / U-Drill System

D2

SP.. - SPMX (AKKO)
- SPMG (TGTC)



ATUM 12.5XD2 SP.. 050204
ATUM 13XD2 SP.. 050204
ATUM 13.5XD2 SP.. 050204
ATUM 14XD2 SP.. 050204
ATUM 14.5XD2 SP.. 050204
ATUM 15XD2 SP.. 050204
ATUM 15.5XD2 SP.. 060204
ATUM 16XD2 SP.. 060204
ATUM 16.5XD2 SP.. 060204
ATUM 17XD2 SP.. 060204
ATUM 17.5XD2 SP.. 060204
ATUM 18XD2 SP.. 060204
ATUM 18.5XD2 SP.. 060204
ATUM 19XD2 SP.. 060204
ATUM 19.5XD2 SP.. 060204
ATUM 20XD2 SP.. 060204
ATUM 20.5XD2 SP.. 060204
ATUM 21XD2 SP.. 060204
ATUM 21.5XD2 SP.. 060204
ATUM 22XD2 SP.. 07T308
ATUM 22XD2 SP.. 07T308-32
ATUM 22.5XD2 SP.. 07T308
ATUM 23XD2 SP.. 07T308
ATUM 23XD2 SP.. 07T308-32
ATUM 23.5XD2 SP.. 07T308
ATUM 24XD2 SP.. 07T308
ATUM 24XD2 SP.. 07T308-32
ATUM 24.5XD2 SP.. 07T308
ATUM 25XD2 SP.. 07T308
ATUM 25XD2 SP.. 07T308-32
ATUM 25.5XD2 SP.. 07T308
ATUM 26XD2 SP.. 07T308
ATUM 26XD2 SP.. 07T308-32
ATUM 26.5XD2 SP.. 07T308
ATUM 27XD2 SP.. 07T308
ATUM 27XD2 SP.. 07T308-32
ATUM 27.5XD2 SP.. 07T308
ATUM 28XD2 SP.. 090408
ATUM 28XD2 SP.. 090408-32
ATUM 28.5XD2 SP.. 090408
ATUM 29XD2 SP.. 090408
ATUM 29XD2 SP.. 090408-32
ATUM 29.5XD2 SP.. 090408
ATUM 30XD2 SP.. 090408
ATUM 30.5XD2 SP.. 090408
ATUM 31XD2 SP.. 090408
ATUM 32XD2 SP.. 090408
ATUM 33XD2 SP.. 090408
ATUM 34XD2 SP.. 110408
ATUM 35XD2 SP.. 110408
ATUM 36XD2 SP.. 110408
ATUM 37XD2 SP.. 110408
ATUM 38XD2 SP.. 110408
ATUM 39XD2 SP.. 110408
ATUM 40XD2 SP.. 110408
ATUM 41XD2 SP.. 110408
ATUM 42XD2 SP.. 140512
ATUM 43XD2 SP.. 140512
ATUM 44XD2 SP.. 140512
ATUM 45XD2 SP.. 140512
ATUM 46XD2 SP.. 140512
ATUM 47XD2 SP.. 140512
ATUM 48XD2 SP.. 140512
ATUM 49XD2 SP.. 140512
ATUM 50XD2 SP.. 140512

TGTC UCUNA UYGUNDUR.
COMPATIBLE WITH TGTC INSERT.

D3

SP.. - SPMX (AKKO)
- SPMG (TGTC)



ATUM 12.5XD3 SP.. 050204
ATUM 13XD3 SP.. 050204
ATUM 13.5XD3 SP.. 050204
ATUM 14XD3 SP.. 050204
ATUM 14.5XD3 SP.. 050204
ATUM 15XD3 SP.. 050204
ATUM 15.5XD3 SP.. 060204
ATUM 16XD3 SP.. 060204
ATUM 16.5XD3 SP.. 060204
ATUM 17XD3 SP.. 060204
ATUM 17.5XD3 SP.. 060204
ATUM 18XD3 SP.. 060204
ATUM 18.5XD3 SP.. 060204
ATUM 19XD3 SP.. 060204
ATUM 19.5XD3 SP.. 060204
ATUM 20XD3 SP.. 060204
ATUM 20.5XD3 SP.. 060204
ATUM 21XD3 SP.. 060204
ATUM 21.5XD3 SP.. 060204
ATUM 22XD3 SP.. 07T308
ATUM 22XD3 SP.. 07T308-32
ATUM 22.5XD3 SP.. 07T308
ATUM 23XD3 SP.. 07T308
ATUM 23XD3 SP.. 07T308-32
ATUM 23.5XD3 SP.. 07T308
ATUM 24XD3 SP.. 07T308
ATUM 24XD3 SP.. 07T308-32
ATUM 24.5XD3 SP.. 07T308
ATUM 25XD3 SP.. 07T308
ATUM 25XD3 SP.. 07T308-32
ATUM 25.5XD3 SP.. 07T308
ATUM 26XD3 SP.. 07T308
ATUM 26XD3 SP.. 07T308-32
ATUM 26.5XD3 SP.. 07T308
ATUM 27XD3 SP.. 07T308
ATUM 27XD3 SP.. 07T308-32
ATUM 27.5XD3 SP.. 07T308
ATUM 28XD3 SP.. 090408
ATUM 28XD3 SP.. 090408-32
ATUM 28.5XD3 SP.. 090408
ATUM 29XD3 SP.. 090408
ATUM 29XD3 SP.. 090408-32
ATUM 29.5XD3 SP.. 090408
ATUM 30XD3 SP.. 090408
ATUM 30.5XD3 SP.. 090408
ATUM 31XD3 SP.. 090408
ATUM 31.5XD3 SP.. 090408
ATUM 32XD3 SP.. 090408
ATUM 32.5XD3 SP.. 090408
ATUM 33XD3 SP.. 090408
ATUM 33.5XD3 SP.. 090408
ATUM 34XD3 SP.. 110408
ATUM 34.5XD3 SP.. 110408
ATUM 35XD3 SP.. 110408
ATUM 35.5XD3 SP.. 110408
ATUM 36XD3 SP.. 110408
ATUM 36.5XD3 SP.. 110408
ATUM 37XD3 SP.. 110408
ATUM 37.5XD3 SP.. 110408
ATUM 38XD3 SP.. 110408
ATUM 38.5XD3 SP.. 110408
ATUM 39XD3 SP.. 110408
ATUM 39.5XD3 SP.. 110408
ATUM 40XD3 SP.. 110408
ATUM 40.5XD3 SP.. 110408
ATUM 41XD3 SP.. 110408
ATUM 41.5XD3 SP.. 110408
ATUM 42XD3 SP.. 140512
ATUM 42.5XD3 SP.. 140512
ATUM 43XD3 SP.. 140512
ATUM 43.5XD3 SP.. 140512
ATUM 44XD3 SP.. 140512
ATUM 44.5XD3 SP.. 140512
ATUM 45XD3 SP.. 140512
ATUM 45.5XD3 SP.. 140512
ATUM 46XD3 SP.. 140512
ATUM 47XD3 SP.. 140512
ATUM 48XD3 SP.. 140512
ATUM 48.5XD3 SP.. 140512
ATUM 49XD3 SP.. 140512
ATUM 50XD3 SP.. 140512
ATUM 51XD3 SP.. 140512
ATUM 52XD3 SP.. 140512

TGTC UCUNA UYGUNDUR.
COMPATIBLE WITH TGTC INSERT.

Delik Delme ve İşleme Takımları / Drilling and Holemaking Tools

Takma Uçlu Matkaplar / U-Drill System

D4 SP.. - SPMX (AKKO) - SPMG (TGTC)



ATUM 13XD4 SP.. 050204
ATUM 14XD4 SP.. 050204
ATUM 14.5XD4 SP.. 050204
ATUM 15XD4 SP.. 050204
ATUM 15.5XD4 SP.. 060204
ATUM 16XD4 SP.. 060204
ATUM 16.5XD4 SP.. 060204
ATUM 17XD4 SP.. 060204
ATUM 17.5XD4 SP.. 060204
ATUM 18XD4 SP.. 060204
ATUM 19XD4 SP.. 060204
ATUM 19.5XD4 SP.. 060204
ATUM 20XD4 SP.. 060204
ATUM 20.5XD4 SP.. 060204
ATUM 21XD4 SP.. 060204
ATUM 21.5XD4 SP.. 060204
ATUM 22XD4 SP.. 07T308
ATUM 22.5XD4 SP.. 07T308
ATUM 23XD4 SP.. 07T308
ATUM 23.5XD4 SP.. 07T308
ATUM 24XD4 SP.. 07T308
ATUM 24.5XD4 SP.. 07T308
ATUM 25XD4 SP.. 07T308
ATUM 25.5XD4 SP.. 07T308
ATUM 26XD4 SP.. 07T308
ATUM 26.5XD4 SP.. 07T308
ATUM 27XD4 SP.. 07T308
ATUM 27.5XD4 SP.. 07T308
ATUM 28XD4 SP.. 090408
ATUM 29XD4 SP.. 090408
ATUM 30XD4 SP.. 090408
ATUM 31XD4 SP.. 090408
ATUM 32XD4 SP.. 090408
ATUM 33XD4 SP.. 090408
ATUM 33.5XD4 SP.. 090408
ATUM 34XD4 SP.. 110408
ATUM 35XD4 SP.. 110408
ATUM 36XD4 SP.. 110408
ATUM 37XD4 SP.. 110408
ATUM 38XD4 SP.. 110408
ATUM 39XD4 SP.. 110408
ATUM 40XD4 SP.. 110408
ATUM 41XD4 SP.. 110408
ATUM 42XD4 SP.. 140512
ATUM 43XD4 SP.. 140512
ATUM 44XD4 SP.. 140512
ATUM 45XD4 SP.. 140512
ATUM 46XD4 SP.. 140512

TGTC UCUNA UYGUNDUR.
COMPATIBLE WITH TGTC INSERT.

D5 SP.. - SPMX (AKKO) - SPMG (TGTC)



ATUM 13XD5 SP.. 050204
ATUM 14XD5 SP.. 050204
ATUM 14.5XD5 SP.. 050204
ATUM 15XD5 SP.. 050204
ATUM 16XD5 SP.. 060204
ATUM 16.5XD5 SP.. 060204
ATUM 17XD5 SP.. 060204
ATUM 17.5XD5 SP.. 060204
ATUM 18XD5 SP.. 060204-32
ATUM 19XD5 SP.. 060204
ATUM 20XD5 SP.. 060204
ATUM 21XD5 SP.. 060204
ATUM 22XD5 SP.. 07T308
ATUM 22.5XD5 SP.. 07T308-32
ATUM 23XD5 SP.. 07T308
ATUM 23.5XD5 SP.. 07T308-32
ATUM 24XD5 SP.. 07T308-32
ATUM 25XD5 SP.. 07T308
ATUM 25.5XD5 SP.. 07T308-32
ATUM 26XD5 SP.. 07T308
ATUM 26.5XD5 SP.. 07T308-32
ATUM 27XD5 SP.. 07T308
ATUM 27.5XD5 SP.. 07T308-32
ATUM 28XD5 SP.. 090408
ATUM 28.5XD5 SP.. 090408-32
ATUM 29XD5 SP.. 090408-32
ATUM 30XD5 SP.. 090408
ATUM 31XD5 SP.. 090408
ATUM 32XD5 SP.. 090408
ATUM 33XD5 SP.. 090408
-new ATUM 37XD5 SP.. 110408
-new ATUM 40XD5 SP.. 110408
-new ATUM 42XD5 SP.. 140512
-new ATUM 48XD5 SP.. 140512
-new ATUM 50XD5 SP.. 140512

TGTC UCUNA UYGUNDUR.
COMPATIBLE WITH TGTC INSERT.

D2 SOMT - (TGTC)



ATUM 14XD2 SOMT 050204
ATUM 16XD2 SOMT 050204
ATUM 17XD2 SOMT 060204
ATUM 18XD2 SOMT 060204
ATUM 20XD2 SOMT 070306
ATUM 22XD2 SOMT 070306
ATUM 23XD2 SOMT 08T306
ATUM 24XD2 SOMT 08T306
ATUM 25XD2 SOMT 08T306
ATUM 26XD2 SOMT 08T306
ATUM 27XD2 SOMT 09T308
ATUM 28XD2 SOMT 09T308
ATUM 29XD2 SOMT 09T308
ATUM 30XD2 SOMT 09T308
ATUM 32XD2 SOMT 11T308
ATUM 33XD2 SOMT 11T308
ATUM 34XD2 SOMT 11T308
ATUM 35XD2 SOMT 11T308
ATUM 37XD2 SOMT 130408
ATUM 38XD2 SOMT 130408
ATUM 40XD2 SOMT 130408
ATUM 45XD2 SOMT 150510
ATUM 47XD2 SOMT 150510

TGTC UCUNA UYGUNDUR.
COMPATIBLE WITH TGTC INSERT.

D3 SOMT - (TGTC)



ATUM 14XD3 SOMT 050204
ATUM 14.5XD3 SOMT 050204
ATUM 15XD3 SOMT 050204
ATUM 15.5XD3 SOMT 050204
ATUM 16XD3 SOMT 050204
ATUM 16.5XD3 SOMT 060204
ATUM 17XD3 SOMT 060204
ATUM 17.5XD3 SOMT 060204
ATUM 18XD3 SOMT 060204
ATUM 18.5XD3 SOMT 060204
ATUM 19XD3 SOMT 060204
ATUM 19.5XD3 SOMT 070306
ATUM 20XD3 SOMT 070306
ATUM 20.5XD3 SOMT 070306

ATUM 21XD3 SOMT 070306
ATUM 22XD3 SOMT 070305
ATUM 22.5XD3 SOMT 08T306
ATUM 23XD3 SOMT 08T306
ATUM 23.5XD3 SOMT 08T306
ATUM 24XD3 SOMT 08T306
ATUM 24.5XD3 SOMT 08T306
ATUM 25XD3 SOMT 08T306
ATUM 26XD3 SOMT 08T306
ATUM 27XD3 SOMT 09T308
ATUM 27.5XD3 SOMT 09T308
ATUM 28XD3 SOMT 09T308
ATUM 29XD3 SOMT 09T308
ATUM 30XD3 SOMT 09T308

ATUM 32XD3 SOMT 11T308
ATUM 33XD3 SOMT 11T308
ATUM 34XD3 SOMT 11T308
ATUM 35XD3 SOMT 11T308
ATUM 36XD3 SOMT 11T308
ATUM 37XD3 SOMT 130408
ATUM 38XD3 SOMT 130408
ATUM 39XD3 SOMT 130408
ATUM 40XD3 SOMT 130408
ATUM 45XD3 SOMT 150510
ATUM 49XD3 SOMT 150510
ATUM 50XD3 SOMT 150510

TGTC UCUNA UYGUNDUR.
COMPATIBLE WITH TGTC INSERT.

Takma Uçlu Matkaplar / U-Drill System

D4 SOMT - (TGTC)



ATUM 14XD4 SOMT 050204
ATUM 14.5XD4 SOMT 050204
ATUM 16XD4 SOMT 050204
ATUM 17XD4 SOMT 060204
ATUM 17.5XD4 SOMT 060204
ATUM 18XD4 SOMT 060204
ATUM 19XD4 SOMT 060204
ATUM 20XD4 SOMT 070306
ATUM 21XD4 SOMT 070306
ATUM 22XD4 SOMT 070306
ATUM 24XD4 SOMT 08T306
ATUM 25XD4 SOMT 08T306

TGTC UCUNA UYGUNDUR.
COMPATIBLE WITH TGTC INSERT.

D5 SOMT - (TGTC)



ATUM 14XD5 SOMT 050204
ATUM 15XD5 SOMT 050204
ATUM 15.5XD5 SOMT 050204
ATUM 16XD5 SOMT 050204
ATUM 16.5XD5 SOMT 050204
ATUM 17XD5 SOMT 060204
ATUM 18XD5 SOMT 060204
ATUM 18.5XD5 SOMT 060204
ATUM 19XD5 SOMT 060204
ATUM 19.5XD5 SOMT 070306
ATUM 20XD5 SOMT 070306
ATUM 21XD5 SOMT 070306
ATUM 22XD5 SOMT 070306
ATUM 23XD5 SOMT 08T306
ATUM 24XD5 SOMT 08T306
ATUM 25XD5 SOMT 08T306
ATUM 26XD5 SOMT 08T306
ATUM 27XD5 SOMT 09T308
ATUM 28XD5 SOMT 09T308
ATUM 29XD5 SOMT 09T308
ATUM 30XD5 SOMT 09T308
ATUM 33XD5 SOMT 11T308
ATUM 34XD5 SOMT 11T308
ATUM 35XD5 SOMT 11T308
ATUM 36XD5 SOMT 11T308

TGTC UCUNA UYGUNDUR.
COMPATIBLE WITH TGTC INSERT.

D2 SPGT - (ZCC)



ATUM 12.5XD2 SPGT 050204
ATUM 13XD2 SPGT 050204
ATUM 13.5XD2 SPGT 050204
ATUM 14XD2 SPGT 050204
ATUM 15XD2 SPGT 050204
ATUM 16XD2 SPGT 060204
ATUM 16.5XD2 SPGT 060204
ATUM 17XD2 SPGT 060204
ATUM 17.5XD2 SPGT 060204
ATUM 18XD2 SPGT 060204
ATUM 19XD2 SPGT 060204
ATUM 20XD2 SPGT 060204
ATUM 21XD2 SPGT 060204
ATUM 22XD2 SPGT 07T308
ATUM 22.5XD2 SPGT 07T308
ATUM 23XD2 SPGT 07T308
ATUM 23.5XD2 SPGT 07T308
ATUM 24XD2 SPGT 07T308
ATUM 24.5XD2 SPGT 07T308
ATUM 25XD2 SPGT 07T308
ATUM 26XD2 SPGT 07T308
ATUM 28XD2 SPGT 090408
ATUM 29XD2 SPGT 090408
ATUM 30XD2 SPGT 090408
ATUM 31XD2 SPGT 090408
ATUM 32XD2 SPGT 090408
ATUM 35XD2 SPGT 110408
ATUM 36XD2 SPGT 110408
ATUM 40XD2 SPGT 110408

ZCC UCUNA UYGUNDUR.
COMPATIBLE WITH ZCC INSERT.

D3 SPGT - (ZCC)



ATUM 12.5XD3 SPGT 050204
ATUM 13XD3 SPGT 050204
ATUM 13.5XD3 SPGT 050204
ATUM 14XD3 SPGT 050204
ATUM 14.5XD3 SPGT 050204
ATUM 15XD3 SPGT 050204
ATUM 15.5XD3 SPGT 060204
ATUM 16XD3 SPGT 060204
ATUM 16.5XD3 SPGT 060204
ATUM 17XD3 SPGT 060204
ATUM 17.5XD3 SPGT 060204
ATUM 18XD3 SPGT 060204
ATUM 18.5XD3 SPGT 060204
ATUM 19XD3 SPGT 060204
ATUM 19.5XD3 SPGT 060204
ATUM 20XD3 SPGT 060204
ATUM 20.5XD3 SPGT 060204
ATUM 21XD3 SPGT 060204
ATUM 21.5XD3 SPGT 060204
ATUM 22XD3 SPGT 07T308
ATUM 22.5XD3 SPGT 07T308
ATUM 23XD3 SPGT 07T308
ATUM 23.5XD3 SPGT 07T308
ATUM 24XD3 SPGT 07T308
ATUM 24.5XD3 SPGT 07T308
ATUM 25XD3 SPGT 07T308
ATUM 25.5XD3 SPGT 07T308
ATUM 26XD3 SPGT 07T308
ATUM 26.5XD3 SPGT 07T308
ATUM 27XD3 SPGT 07T308
ATUM 27.5XD3 SPGT 07T308
ATUM 28XD3 SPGT 090408
ATUM 28.5XD3 SPGT 090408
ATUM 29XD3 SPGT 090408
ATUM 29.5XD3 SPGT 090408

ZCC UCUNA UYGUNDUR.
COMPATIBLE WITH ZCC INSERT.

Delik Delme ve İşleme Takımları / Drilling and Holemaking Tools

Takma Uçlu Matkaplar / U-Drill System

D3 SPGT - (ZCC)



ATUM 30XD3 SPGT 090408
 ATUM 31XD3 SPGT 090408
 ATUM 32XD3 SPGT 090408
 ATUM 33XD3 SPGT 090408
 ATUM 34XD3 SPGT 110408
 ATUM 35XD3 SPGT 110408
 ATUM 36XD3 SPGT 110408
 ATUM 36.5XD3 SPGT 110408
 ATUM 37XD3 SPGT 110408
 ATUM 38XD3 SPGT 110408
 ATUM 39XD3 SPGT 110408
 ATUM 40XD3 SPGT 110408
 ATUM 42XD3 SPGT 140512
 ATUM 43XD3 SPGT 140512
 ATUM 44XD3 SPGT 140512
 ATUM 49XD3 SPGT 140512
 ATUM 50XD3 SPGT 140512

ZCC UCUNA UYGUNDUR.
 COMPATIBLE WITH ZCC INSERT.

D4 SPGT - (ZCC)



ATUM 13XD4 SPGT 050204
 ATUM 14XD4 SPGT 050204
 ATUM 14.5XD4 SPGT 050204
 ATUM 15XD4 SPGT 050204
 ATUM 16XD4 SPGT 060204
 ATUM 17XD4 SPGT 060204
 ATUM 17.5XD4 SPGT 060204
 ATUM 18XD4 SPGT 060204
 ATUM 19XD4 SPGT 060204
 ATUM 19.5XD4 SPGT 060204
 ATUM 20XD4 SPGT 060204
 ATUM 21XD4 SPGT 060204
 ATUM 22XD4 SPGT 07T308
 ATUM 23XD4 SPGT 07T308
 ATUM 23.5XD4 SPGT 07T308
 ATUM 24XD4 SPGT 07T308
 ATUM 25XD4 SPGT 07T308
 ATUM 26XD4 SPGT 07T308
 ATUM 27.5XD4 SPGT 07T308
 ATUM 28XD4 SPGT 090408
 ATUM 29XD4 SPGT 090408
 ATUM 30XD4 SPGT 090408
 ATUM 31XD4 SPGT 090408
 ATUM 32XD4 SPGT 090408
 ATUM 33.5XD4 SPGT 090408
 ATUM 38XD4 SPGT 110408

ZCC UCUNA UYGUNDUR.
 COMPATIBLE WITH ZCC INSERT.

D5 SPGT - (ZCC)



ATUM 22XD5 SPGT 07T308
 ATUM 26XD5 SPGT 07T308-32
 -new ATUM 30XD5 SPGT 090408
 -new ATUM 31XD5 SPGT 090408
 -new ATUM 32XD5 SPGT 090408
 -new ATUM 33XD5 SPGT 090408
 -new ATUM 35XD5 SPGT 110408

ZCC UCUNA UYGUNDUR.
 COMPATIBLE WITH ZCC INSERT.

Ekokes-Delik Delme, Delik İçi ve Dış Çap Tornalama Ekokes-Drilling, Boring and External Turning



AEKR/L-D2.25X8 XC.. 040104
 AEKR/L-D2.25X10 XC.. 050204
 AEKR/L-D2.25X12 XC.. 060204
 AEKR/L-D2.25X14 XC.. 070304
 AEKR/L-D2.25X16 XC.. 080304
 AEKR/L-D2.25X18 XC.. 09T304
 AEKR/L-D2.25X20 XC.. 10T304
 AEKR/L-D2.25X25 XC.. 130404
 AEKR/L-D2.25X32 XC.. 170504

CRTZT UCUNA UYGUNDUR.
 COMPATIBLE WITH CRTZT INSERT.

Ekokes-Delik Delme, Delik İçi ve Dış Çap Tornalama Ekokes-Drilling, Boring and External Turning



AEKR/L-D2.25X8 XC.. 040104
 AEKR/L-D2.25X10 XC.. 050204
 AEKR/L-D2.25X12 XC.. 060204
 AEKR/L-D2.25X14 XC.. 070304
 AEKR/L-D2.25X16 XC.. 080304
 AEKR/L-D2.25X18 XC.. 09T304
 AEKR/L-D2.25X20 XC.. 10T304
 AEKR/L-D2.25X25 XC.. 130404
 AEKR/L-D2.25X32 XC.. 170504

ISCR UCUNA UYGUNDUR.
 COMPATIBLE WITH
 ISCR INSERT.



AEKR/L-D2.25X8 XC.. 040104
 AEKR/L-D2.25X10 XC.. 050204
 AEKR/L-D2.25X12 XC.. 060204
 AEKR/L-D2.25X14 XC.. 070304
 AEKR/L-D2.25X16 XC.. 080304
 AEKR/L-D2.25X18 XC.. 09T304
 AEKR/L-D2.25X20 XC.. 10T304
 AEKR/L-D2.25X25 XC.. 130404
 AEKR/L-D2.25X32 XC.. 170504

KRLY UCUNA UYGUNDUR.
 COMPATIBLE WITH
 KRLY INSERT.



AEKR/L-D2.25X8 XC.. 040104
 AEKR/L-D2.25X10 XC.. 050204
 AEKR/L-D2.25X12 XC.. 060204
 AEKR/L-D2.25X14 XC.. 070304
 AEKR/L-D2.25X16 XC.. 080304
 AEKR/L-D2.25X18 XC.. 09T304
 AEKR/L-D2.25X20 XC.. 10T304
 AEKR/L-D2.25X25 XC.. 130404
 AEKR/L-D2.25X32 XC.. 170504

TGTC UCUNA UYGUNDUR.
 COMPATIBLE WITH
 TGTC INSERT.

Ayarlı Hassas Delik İşleme Bara Setleri / Adjustable Finish Boring Sets



Takım Kodu / Tool Code	Ölçü Aralığı / Boring Range	Bara Gövde Takım Kodu / Boring Head Body Code
SET-I-ABHF-D06X30-WA25	06-30	ABHF-D06X30-WA25

Hassas bara setlerimiz 0,2 veya 0,4 radiuslü uçlardan oluşmaktadır. Siparişinizle birlikte uç detayını satış temsilcisi ile paylaşmanızı rica ederiz.
Sipariş örneği: WCGT020102L/WCGT020104L

Our fine boring sets consist of inserts with 0.2 or 0.4 radius. We kindly ask you to share the insert radius details with the sales representative with your order.
Ordering Example:WCGT020102L/WCGT020104L

Unsere Einstellbare Bohr Set bestehen aus Wendeschneidplatten mit einem Radius von 0,2 oder 0,4. Wir bitten Sie, die Angaben zum Wendeschneidplattenradius bei Ihrer Bestellung dem Vertriebsmitarbeiter mitzuteilen. *Bestellbeispiel:WCGT020102L/WCGT020104L



Takım Kodu / Tool Code	Ölçü Aralığı / Boring Range	Bara Gövde Takım Kodu / Boring Head Body Code
SET-I-ABHF-D29X40-WA16	29-40	ABHF-D29X40-WA16
SET-I-ABHF-D39X54-WA20	39-54	ABHF-D39X54-WA20
SET-I-ABHF-D52X80-WA25	52-80	ABHF-D52X80-WA25
SET-I-ABHF-D78X170-WA32	78-170	ABHF-D78X170-WA32

SET-I-ABHF-D78X170-WA32 takım uzatma adaptörü kullanılarak 117-170 ölçü aralığında operasyon yapmaktadır.

SET-I-ABHF-D78X170-WA32 operates in the 117-170 size range by using the extension adapter.

SET-I-ABHF-D78X170-WA32 funktioniert im Größenbereich 117-170 durch Verwendung des Verlängerungsadapters.

Hassas bara setlerimiz 0,2 veya 0,4 radiuslü uçlardan oluşmaktadır. Siparişinizle birlikte uç detayını satış temsilcisi ile paylaşmanızı rica ederiz.
Sipariş örneği: WCGT020102L/WCGT020104L

Our fine boring sets consist of inserts with 0.2 or 0.4 radius. We kindly ask you to share the insert radius details with the sales representative with your order
Ordering Example:WCGT020102L/WCGT020104L

Unsere Einstellbare Bohr Set bestehen aus Wendeschneidplatten mit einem Radius von 0,2 oder 0,4. Wir bitten Sie, die Angaben zum Wendeschneidplattenradius bei Ihrer Bestellung dem Vertriebsmitarbeiter mitzuteilen. Bestellbeispiel:WCGT020102L/WCGT020104L



Takım Kodu / Tool Code	Ölçü Aralığı / Boring Range	Bara Gövde Takım Kodu / Boring Head Body Code
SET-ABHF-D06X30-WA25	06-30	ABHF-D06X30-WA25



Takım Kodu / Tool Code	Ölçü Aralığı / Boring Range	Bara Gövde Takım Kodu / Boring Head Body Code
SET-ABHF-D29X40-WA16	29-40	ABHF-D29X40-WA16
SET-ABHF-D39X54-WA20	39-54	ABHF-D39X54-WA20
SET-ABHF-D52X80-WA25	52-80	ABHF-D52X80-WA25
SET-ABHF-D78X170-WA32	78-170	ABHF-D78X170-WA32

SET-ABHF-D78X170-WA32 takım uzatma adaptörü kullanılarak 117-170 ölçü aralığında operasyon yapmaktadır.

SET-ABHF-D78X170-WA32 operates in the 117-170 size range by using the extension adapter.

SET-ABHF-D78X170-WA32 funktioniert im Größenbereich 117-170 durch Verwendung des Verlängerungsadapters.

Delik Delme ve İşleme Takımları / Drilling and Holemaking Tools

Ayarlı Hassas Delik İşleme Baraları / Adjustable Finish Boring Heads

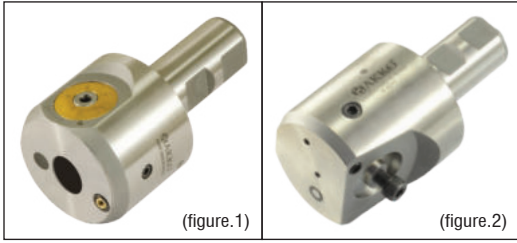

Takım Kodu / Tool Code	Ölçü Aralığı / Boring Range
ABHF-D06X30-WA25 (figure.1)	06-30
ABHF-D29X40-WA16 (figure.2)	29-40
ABHF-D39X54-WA20 (figure.2)	39-54
ABHF-D52X80-WA25 (figure.2)	52-80
ABHF-D78X170-WA32 (figure.2)	78-170

Hassas Bara Uzatma Adaptörü Extension For Fine Boring Tools



Takım Kodu / Tool Code
AEA-114x134
AEA-132x152

Hassas Delik İşleme Bara Kartuşları / Finish Boring Heads Cartridge

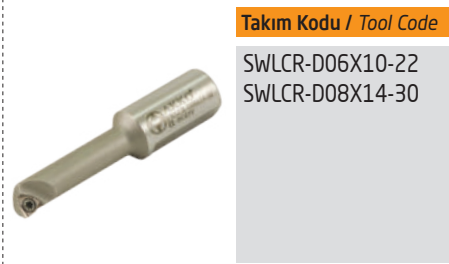

Takım Kodu / Tool Code
SWLCR-D06X10-22
SWLCR-D08X14-30



Takım Kodu / Tool Code
STUPR-D12X18-40
STUPR-D16X22-40
STUPR-D20X26-40
STUPR-D24X30-50



Takım Kodu / Tool Code
STFPR-D29x35
STFPR-D34x40
STFPR-D39x47
STFPR-D46x54
STFPR-D52x68
STFPR-D64x80
STFPR-D78x98
STFPR-D96x116

Ayarlı Kaba Delik İşleme Baraları / Adjustable Rough Boring Heads



Takım Kodu / Tool Code	Dmin-Dmax
ABHR-D18x22-W16-L90-CC06	18-22
ABHR-D18x22-W16-L150-CC06	18-22
ABHR-D18x22-W16-L200-CC06	18-22
ABHR-D22x28-W20-L100-CC06	22-28
ABHR-D22x28-W20-L150-CC06	22-28
ABHR-D22x28-W20-L200-CC06	22-28
ABHR-D28x38-W20-L110-CC06	28-38
ABHR-D28x38-W20-L160-CC06	28-38
ABHR-D28x38-W20-L230-CC06	28-38
ABHR-D36x50-W25-L120-CC06	36-50
ABHR-D36x50-W25-L170-CC06	36-50
ABHR-D36x50-W25-L250-CC06	36-50
ABHR-D36x50-W25-L120-CC09	36-50
ABHR-D36x50-W25-L170-CC09	36-50
ABHR-D36x50-W25-L250-CC09	36-50
ABHR-D50x68-W32-L140-CC09	50-68
ABHR-D50x68-W32-L200-CC09	50-68
ABHR-D50x68-W32-L280-CC09	50-68
ABHR-D50x68-W32-L140-CC12	50-68
ABHR-D50x68-W32-L200-CC12	50-68
ABHR-D50x68-W32-L280-CC12	50-68
ABHR-D68x90-W32-L160-CC12	68-90
ABHR-D68x90-W32-L210-CC12	68-90
ABHR-D68x90-W32-L280-CC12	68-90
ABHR-D90x120-W32-L140-CC12	90-120
ABHR-D90x120-W40-L200-CC12	90-120
ABHR-D90x120-W40-L300-CC12	90-120
ABHR-D120x160-W40-L210-CC12	120-160
ABHR-D120x160-W40-L300-CC12	120-160
ABHR-D160x200-W40-L210-B-CC12	160-200
ABHR-D160x200-W40-L300-B-CC12	160-200

Ayarlı Kaba Delik İşleme Bara Gövdesi / Adjustable Rough Boring Heads Body



Takım Kodu / Tool Code	Kartuş / Cartridge
ABHRS-D16x42-W16-L90	AK.. 18-22
ABHRS-D16x102-W16-L150	AK.. 18-22
ABHRS-D16x152-W16-L200	AK.. 18-22
ABHRS-D20x50-W20-L100	AK.. 22-28
ABHRS-D20x100-W20-L150	AK.. 22-28
ABHRS-D20x150-W20-L200	AK.. 22-28
ABHRS-D25x60-W20-L110	AK.. 28-38
ABHRS-D25x110-W20-L160	AK.. 28-38
ABHRS-D25x180-W20-L230	AK.. 28-38
ABHRS-D32X64-W25-L120	AK.. 36-50
ABHRS-D32X114-W25-L170	AK.. 36-50
ABHRS-D32X194-W25-L250	AK.. 36-50
ABHRS-D32X64-W25-L120	AK.. 36-50-09
ABHRS-D32X114-W25-L170	AK.. 36-50-09
ABHRS-D32X194-W25-L250	AK.. 36-50-09
ABHRS-D40x80-W32-L140	AK.. 50-68
ABHRS-D40x140-W32-L200	AK.. 50-68
ABHRS-D40x220-W32-L280	AK.. 50-68
ABHRS-D40x80-W32-L140	AK.. 50-68-12
ABHRS-D40x140-W32-L200	AK.. 50-68-12
ABHRS-D40x220-W32-L280	AK.. 50-68-12
ABHRS-D50x100-W32-L160	AK.. 68-90
ABHRS-D50x150-W32-L210	AK.. 68-90
ABHRS-D50x220-W32-L280	AK.. 68-90
ABHRS-D63x80-W32-L140	AK.. 90-120
ABHRS-D63x130-W40-L200	AK.. 90-120
ABHRS-D63x230-W40-L300	AK.. 90-120
ABHRS-D80x140-W40-L210	AK.. 120-160
ABHRS-D80x230-W40-L300	AK.. 120-160
ABHRS-D80x140-W40-L210	AK.. 160-200
ABHRS-D80x230-W40-L300	AK.. 160-200

Ayarlı Kaba Delik İşleme Bara Kartuşları / Adjustable Rough Boring Heads Cartridge



Takım Kodu / Tool Code	Ölçü Aralığı-Boring Range
AKSR 18-22	18-22
AKSR 22-28	22-28
AKSR 28-38	28-38
AKSR 36-50	36-50
AKSR 36-50-09	36-50
AKSR 50-68	50-68
AKSR 50-68-12	50-68
AKSR 68-90	68-90
AKSR 90-120	90-120
AKSR 120-160	120-160
AKSR 160-200	160-200

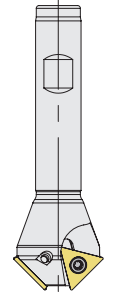
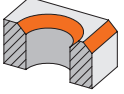

Takım Kodu / Tool Code	Ölçü Aralığı-Boring Range
AKCR 28-38	28-38
AKCR 36-50	36-50
AKCR 36-50-09	36-50
AKCR 50-68	50-68
AKCR 50-68-12	50-68
AKCR 68-90	68-90
AKCR 90-120	90-120
AKCR 120-160	120-160
AKCR 160-200	160-200

-°	ACM...-TC..	Uç / Insert	Takım Kodu / Tool Code	
  		T.C.T 16T304	ACM10-TC16-D17X22-W16-L90-Z01	
			ACM15-TC16-D17X24-W16-L90-Z01	
			ACM15-TC16-D22X29-W16-L100-Z01	
			ACM15-TC16-D30X37-W20-L100-Z02	
			ACM15-TC16-D35X42-W20-L100-Z03	
			ACM15-TC16-D52X59-W25-L110-Z03	
			ACM17.5-TC16-D17X25-W16-L90-Z01	
			ACM18.5-TC16-D21.3X30-W20-L100-Z02	
			ACM19.5-TC16-D17X27-W16-L100-Z01	
			ACM20-TC16-D12X22-W16-L100-Z01	
			ACM20-TC16-D17X27-W16-L100-Z01	
			ACM20-TC16-D23X33-W20-L100-Z02	
			ACM20-TC16-D28X38-W20-L100-Z02	
			ACM20-TC16-D35X45-W20-L100-Z03	
			ACM20-TC16-D39X49-W20-L100-Z03	
			ACM20-TC16-D45X55-W25-L110-Z03	
			ACM20-TC16-D51X61-W25-L110-Z03	
			ACM22.5-TC16-D17X28-W16-L100-Z01	
			ACM25-TC16-D17X29-W16-L100-Z01	
			ACM30-TC16-D6X20-W16-L100-Z01	
			ACM30-TC16-D15X30-W16-L100-Z01	
			ACM30-TC16-D17.5X32.5-W20-L100-Z02	
			ACM30-TC16-D20X35-W16-L100-Z02	
			ACM30-TC16-D30X45-W20-L100-Z02	
			ACM30-TC16-D35X50-W20-L100-Z03	
			ACM30-TC16-D45X60-W25-L110-Z03	
			ACM40-TC16-D18X37-W20-L100-Z02	
			T.C.T 090204	ACM45-TC09-D7X18-W16-L100-Z02
			T.C.T 110204	ACM45-TC11-D8X21.5-W16-L90-Z02
				ACM45-TC11-D11X24-W16-L100-Z02
	ACM45-TC16-D5X26-W16-L100-Z01			
	ACM45-TC16-D10X31-W16-L100-Z02			
	ACM45-TC16-D10X31-W20-L100-Z02			
	ACM45-TC16-D14X35-W20-L100-Z02			
	ACM45-TC16-D18X39-W16-L100-Z02			
	ACM45-TC16-D18X39-W20-L100-Z02			
	ACM45-TC16-D20X41-W20-L100-Z02			
	ACM45-TC16-D30X51-W20-L100-Z02			
	ACM50-TC16-D16X39-W20-L100-Z03			
	ACM55-TC16-D16X40-W20-L100-Z03			
	ACM62-TC16-D14X40-W20-L100-Z03			
	ACM72-TC16-D14X42-W20-L100-Z03			

ISO UCUNA UYGUNDUR.
COMPATIBLE WITH ISO INSERT.

60°	ATM60..	Uç / Insert	Takım Kodu / Tool Code
		T.BGT 060102	ATM60-TB0601-D13-C10-L150-Z02-H
		T.C.T 090202	ATM60-TC0902-D20.5-C16-L150-Z02-H
		T.C.T 110202	ATM60-TC1102-D26-C20-L150-Z03-H
		T.C.T 16T304	ATM60-TC16T3-D32-C25-L150-Z02-H
			ATM60-TC16T3-D40-C32-L250-Z03-H

ISO UCUNA UYGUNDUR.
COMPATIBLE WITH ISO INSERT.

-°	AHM...-AP16..	Uç / Insert	Takım Kodu / Tool Code
		AP.. 1604..	AHM15-AP16-D35x93-A27-Z0306-H
			AHM30-AP16-D35x87-A27-Z0306-H
			AHM45-AP16-D35x77-A27-Z0306-H
			AHM60-AP16-D35x65-A22-Z0306-H
			AHM75-AP16-D35x50-A22-Z0306-H

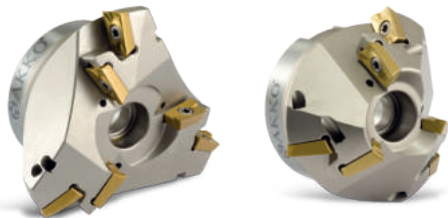

ISO UCUNA UYGUNDUR.
COMPATIBLE WITH ISO INSERT.



90°	AEM90-AP..	Uç / Insert	Takım Kodu / Tool Code
		AP.. 1003..	AEM90-AP10-D10-C10-L100-Z01
			AEM90-AP10-D12-C16-L100-Z01-H
			AEM90-AP10-D12-W16-L100-Z01-H
			AEM90-AP10-D12-W16-L150-Z01
			AEM90-AP10-D14-W16-L100-Z01-H
			AEM90-AP10-D14-W16-L150-Z01
			AEM90-AP10-D16-C16-L100-Z02-H
			AEM90-AP10-D16-C16-L100-Z02-H
			AEM90-AP10-D16-W16-L100-Z02-H
			AEM90-AP10-D16-W16-L150-Z02-H
			AEM90-AP10-D16-W16-L200-Z02
			AEM90-AP10-D16-C16-L120-Z02-H
			AEM90-AP10-D16-C16-L250-Z02-H
			AEM90-AP10-D16-C16-L150-Z02
			AEM90-AP10-D16-C16-L150-Z02-H
			AEM90-AP10-D16-W16-L150-Z02
			AEM90-AP10-D16-C16-L200-Z02
			AEM90-AP10-D16-C16-L200-Z02-H
			AEM90-AP10-D16-C16-L250-Z02
			AEM90-AP10-D17-C16-L150-Z02
			AEM90-AP10-D18-W16-L100-Z02-H
			AEM90-AP10-D18-W16-L150-Z02
			AEM90-AP10-D20-C19-L180-Z02
			AEM90-AP10-D20-C20-L100-Z03-H
			AEM90-AP10-D20-W20-L90-Z03-H
			AEM90-AP10-D20-W20-L100-Z03-H
			AEM90-AP10-D20-C20-L120-Z03-H
			AEM90-AP10-D20-C20-L150-Z03
			AEM90-AP10-D20-C20-L150-Z03-H
			AEM90-AP10-D20-W20-L150-Z03
			AEM90-AP10-D20-C20-L200-Z02
			AEM90-AP10-D20-C20-L200-Z03-H
			AEM90-AP10-D20-C20-L250-Z02
			AEM90-AP10-D20-C20-L250-Z02-H
			AEM90-AP10-D20.5-C20-L90-Z03
			AEM90-AP10-D21-C20-L150-Z03
			AEM90-AP10-D21-C20-L200-Z03
			AEM90-AP10-D21-C20-L200-Z03-H
			AEM90-AP10-D21-W20-L150-Z03
			AEM90-AP10-D22-W20-L100-Z03-H
			AEM90-AP10-D22-W20-L150-Z03
			AEM90-AP10-D22.5-W20-L150-Z03
			AEM90-AP10-D23-W20-L150-Z03
			AEM90-AP10-D24-W20-L150-Z03
			AEM90-AP10-D25-W25-L100-Z04-H
			AEM90-AP10-D25-W25-L95-Z04-H
			AEM90-AP10-D25-W25-L150-Z04-H
			AEM90-AP10-D25-C25-L100-Z03-H
			AEM90-AP10-D25-C25-L120-Z03-H
			AEM90-AP10-D25-C25-L150-Z03
AEM90-AP10-D25-W25-L150-Z03			
AEM90-AP10-D25-C25-L200-Z02			
AEM90-AP10-D25-C25-L200-Z03			
AEM90-AP10-D25-C25-L250-Z02			
AEM90-AP10-D26-C25-L200-Z04			
AEM90-AP10-D30-C25-L100-Z04-H			
AEM90-AP10-D30-C25-L120-Z04-H			
AEM90-AP10-D30-C25-L150-Z04			
AEM90-AP10-D32-C25-L100-Z04-H			
AEM90-AP10-D32-C25-L120-Z04-H			
AEM90-AP10-D32-C25-L150-Z04			
AEM90-AP10-D32-W25-L150-Z04			
AEM90-AP10-D32-C32-L120-Z04-H			

ISO UCUNA UYGUNDUR.
COMPATIBLE WITH ISO INSERT.

Frezeleme Takımları / Milling Tools

90°	AEM90-AP..	Uç / Insert	Takım Kodu / Tool Code	90°	AHM90-AP10	Uç / Insert	Takım Kodu / Tool Code
			<p>AEM90-AP10-D32-C32-L170-Z04 AEM90-AP10-D32-W25-L105-Z05-H AEM90-AP10-D32-C32-L130-Z05 AEM90-AP10-D32-W32-L120-Z04-H AEM90-AP10-D32-W32-L150-Z04 AEM90-AP10-D40-W32-L150-Z05 AEM90-AP16-D25-C20-L100-Z02 AEM90-AP16-D25-C20-L100-Z02-H AEM90-AP16-D25-W25-L100-Z02-H AEM90-AP16-D25-W25-L150-Z02 new AEM90-AP16-D25-W25-L200-Z02 AEM90-AP16-D25-C25-L250-Z02 AEM90-AP16-D28-W25-L100-Z03-H AEM90-AP16-D28-W25-L150-Z03 AEM90-AP16-D30-W25-L110-Z03-H AEM90-AP16-D30-W25-L150-Z02 AEM90-AP16-D30-W25-L150-Z03 AP. 1003.. AEM90-AP16-D32-C25-L110-Z03-H new AEM90-AP16-D32-C32-L200-Z02 AEM90-AP16-D32-W32-L110-Z03-H AEM90-AP16-D32-C32-L150-Z03 AEM90-AP16-D32-W25-L150-Z03 AEM90-AP16-D32-W32-L150-Z03 AEM90-AP16-D32-W32-L150-Z03-H AEM90-AP16-D32-C25-L200-Z03-H AEM90-AP16-D32-C32-L250-Z02 AEM90-AP16-D32-C32-L250-Z03 AEM90-AP16-D35-W32-L150-Z03 AEM90-AP16-D36-W32-L110-Z03-H AEM90-AP16-D36-W32-L150-Z03 AEM90-AP16-D40-W32-L110-Z04-H AEM90-AP16-D40-C32-L150-Z04 AEM90-AP16-D40-W32-L150-Z04 AEM90-AP16-D40-C32-L250-Z02 AEM90-AP16-D40-C32-L250-Z04</p>				<p>AHM90-AP10-D20-W20-L087-Z0204 AHM90-AP10-D20-W20-L087-Z0206 AHM90-AP10-D25-W25-L105-Z0208-H AHM90-AP10-D32-W32-L115-Z0315-H AHM90-AP10-D40-W32-L130-Z0318-H</p>
						<p>ISO UCUNA UYGUNDUR. COMPATIBLE WITH ISO INSERT.</p>	
90°	AEM90-AP..	Uç / Insert	Takım Kodu / Tool Code	90°	AEM90-AP..	Uç / Insert	Takım Kodu / Tool Code
			<p>new AEM90-AP10-D16-M08-L30-Z02-H AEM90-AP10-D20-M10-L30-Z03-H AEM90-AP10-D25-M12-L35-Z03-H AEM90-AP10-D32-M16-L35-Z04-H AEM90-AP10-D32-M16-L40-Z04-H AEM90-AP10-D40-M16-L43-Z05-H AEM90-AP10-D42-M16-L43-Z05-H AEM90-AP16-D25-M12-L43-Z02-H AEM90-AP16-D32-M16-L43-Z03-H AEM90-AP16-D40-M16-L43-Z04-H AEM90-AP16-D42-M16-L43-Z04-H</p>				<p>AP. 1003..</p> <p>AP. 1604..</p>
						<p>ISO UCUNA UYGUNDUR. COMPATIBLE WITH ISO INSERT.</p>	
75°	AFM75-AP16	Uç / Insert	Takım Kodu / Tool Code	75°	AFM75-AP16	Uç / Insert	Takım Kodu / Tool Code
			<p>AFM75-AP16-D063-A22-Z04-H AFM75-AP16-D080-A27-Z05-H AFM75-AP16-D100-A32-Z06-H AFM75-AP16-D125-B40-Z07</p>				<p>AP. 1604..</p>
						<p>ISO UCUNA UYGUNDUR. COMPATIBLE WITH ISO INSERT.</p>	
90°	AFM90-AP..	Uç / Insert	Takım Kodu / Tool Code	90°	AFM90-AP..	Uç / Insert	Takım Kodu / Tool Code
			<p>AFM90-AP10-D040-A16-Z04-H AFM90-AP10-D040-A16-Z05-H AFM90-AP10-D050-A22-Z06-H AFM90-AP10-D050-A22-Z07-H AFM90-AP10-D063-A22-Z06 AFM90-AP10-D063-A22-Z07-H AFM90-AP10-D063-A22-Z09 AFM90-AP10-D080-A27-Z08-H AFM90-AP10-D100-A32-Z09-H AFM90-AP16-D040-A16-Z04-H AFM90-AP16-D050-A22-Z05-H AFM90-AP16-D052-A22-Z05-H AFM90-AP16-D063-A22-Z06-H AFM90-AP16-D080-A27-Z07-H AFM90-AP16-D100-A32-Z08-H AFM90-AP16-D125-B40-Z09 AFM90-AP16-D160-C40-Z10 AFM90-AP16-D200-C60-Z12</p>				<p>AP. 1003..</p> <p>AP. 1604..</p>
						<p>ISO UCUNA UYGUNDUR. COMPATIBLE WITH ISO INSERT.</p>	
°	ACBM-..	Uç / Insert	Takım Kodu / Tool Code	°	ACBM-..	Uç / Insert	Takım Kodu / Tool Code
			<p>ACBM-CC06-D17X6-W16-L150-Z02 ACBM-CC06-D18X7-W16-L100-Z02-H ACBM-CC06-D18X7-W16-L160-Z02-H ACBM-CC06-D20X9-W20-L100-Z02-H ACBM-CC06-D20X9-W20-L160-Z02-H ACBM-CC09-D26X8.5-W25-L130-Z02-H ACBM-CC09-D26X8.5-W25-L200-Z02 ACBM-CC09-D30X12.5-W32-L130-Z02-H ACBM-CC09-D33X15.5-W32-L130-Z02-H ACBM-CC09-D33X15.5-W32-L200-Z02-H ACBM-SP06-D15X4-W16-L160-Z02-H</p>				<p>CC. 0602..</p> <p>CC. 09T3..</p> <p>SP. 060204</p>
						<p>ISO UCUNA UYGUNDUR. COMPATIBLE WITH ISO INSERT.</p>	
90°	ATSM90-CC..	Uç / Insert	Takım Kodu / Tool Code	90°	ATSM90-CC..	Uç / Insert	Takım Kodu / Tool Code
			<p>ATSM90-CC06-D17X8-W16-L85-Z02 ATSM90-CC06-D22X8-W20-L83-Z04 ATSM90-CC06-D28X8-W20-L66-Z04 ATSM90-CC06-D32X8-W25-L100-Z04 ATSM90-CC06-D45.5X8-W25-L100-Z06 ATSM90-CC06-D63X8-W32-L125-Z08 ATSM90-CC06-D18X9-W16-L90-Z02 ATSM90-CC06-D20X9-W16-L85-Z04 ATSM90-CC06-D23X10-W20-L90-Z04 ATSM90-CC06-D32X10-W25-L100-Z04 ATSM90-CC06-D45X10-W32-L120-Z06 ATSM90-CC06-D25X11-W25-L100-Z04 ATSM90-CC09-D30X12-W25-L100-Z04 ATSM90-CC09-D32X12-W25-L100-Z02 ATSM90-CC09-D32X12-W25-L100-Z04 ATSM90-CC09-D32X14-W25-L100-Z04 ATSM90-CC09-D37X16-W32-L120-Z04 ATSM90-CC09-D42X17-W32-L120-Z04 ATSM90-CC09-D40X17-W32-L120-Z04 ATSM90-CC12-D47X20-W32-L120-Z04 ATSM90-CC12-D52X21-W32-L120-Z04 ATSM90-CC12-D50X22-W32-L120-Z04 ATSM90-CC12-D55X22-W32-L120-Z04</p>				<p>CC. 0602..</p> <p>CC. 09T3..</p> <p>CC. 1204..</p>
						<p>ISO UCUNA UYGUNDUR. COMPATIBLE WITH ISO INSERT.</p>	
90°	ASDM-CC..	Uç / Insert	Takım Kodu / Tool Code	90°	ASDM-CC..	Uç / Insert	Takım Kodu / Tool Code
			<p>ASDM-CC06-D80x8-d27-Z10 ASDM-CC06-D100x8-d32-Z12 ASDM-CC06-D125x8-d40-Z14 ASDM-CC06-D160x8-d40-Z16 ASDM-CC06-D200x8-d40-Z18 ASDM-CC06-D80x10-d27-Z10 ASDM-CC06-D100x10-d32-Z12 ASDM-CC06-D125x10-d40-Z14 ASDM-CC06-D160x10-d40-Z16 ASDM-CC06-D200x10-d40-Z18</p>				<p>CC. 0602..</p>
						<p>ISO UCUNA UYGUNDUR. COMPATIBLE WITH ISO INSERT.</p>	

90°	ASDM-CC..	Uç / Insert	Takım Kodu / Tool Code
	CC.. 09T3..		ASDM-CC09-D80x12-d27-Z08
			ASDM-CC09-D100x12-d32-Z10
			ASDM-CC09-D125x12-d40-Z12
			ASDM-CC09-D160x12-d40-Z14
			ASDM-CC09-D200x12-d40-Z16
			ASDM-CC09-D80x14-d27-Z08
			ASDM-CC09-D100x14-d32-Z10
			ASDM-CC09-D125x14-d40-Z12
			ASDM-CC09-D160x14-d40-Z14
			ASDM-CC09-D200x14-d40-Z16
			ASDM-CC12-D80x16-d27-Z06
			ASDM-CC12-D100x16-d32-Z08
			ASDM-CC12-D125x16-d40-Z10
			ASDM-CC12-D160x16-d40-Z12
	ASDM-CC12-D200x16-d40-Z14		
	CC.. 1204..		ASDM-CC12-D80x18-d27-Z06
			ASDM-CC12-D100x18-d32-Z08
			ASDM-CC12-D125x18-d40-Z10
			ASDM-CC12-D160x18-d40-Z12
			ASDM-CC12-D200x18-d40-Z14
			ASDM-CC12-D250x18-d40-Z16
			ASDM-CC12-D80x20-d27-Z06
			ASDM-CC12-D100x20-d32-Z08
			ASDM-CC12-D125x20-d40-Z10
			ASDM-CC12-D160x20-d40-Z12
			ASDM-CC12-D200x20-d40-Z14
			ASDM-CC12-D250x20-d40-Z16

ISO UCUNA UYGUNDUR.
COMPATIBLE WITH ISO INSERT.

90°	AEMR-RD..	Uç / Insert	Takım Kodu / Tool Code		
	RD.. 0702		AEMR-RD0702-D15-M08-L23-Z02-H		
			AEMR-RD0702-D16-M08-L23-Z02-H		
			AEMR-RD0702-D20-M10-L30-Z04-H		
			AEMR-RD0702-D25-M12-L35-Z05-H		
			AEMR-RD0702-D30-M16-L42-Z05-H		
			AEMR-RD0702-D32-M16-L43-Z05-H		
			AEMR-RD0702-D35-M16-L42-Z06-H		
			AEMR-RD0702-D42-M16-L43-Z05-H		
			AEMR-RD0702-D42-M16-L43-Z07-H		
			AEMR-RD08T2-D16-M08-L23-Z02-H		
			RD.. 08T2		AEMR-RD08T2-D20-M10-L30-Z03-H
					AEMR-RD08T2-D25-M12-L35-Z04-H
					AEMR-RD10T3-D25-M12-L35-Z03-H
					AEMR-RD10T3-D32-M16-L45-Z04-H
	RD.. 08T2		AEMR-RD10T3-D35-M16-L43-Z04-H		
			AEMR-RD10T3-D42-M16-L43-Z05-H		
			AEMR-RD0803-D16-M08-L23-Z02-H		
	RD.. 0803		AEMR-RD0803-D20-M10-L30-Z03-H		
			AEMR-RD0803-D25-M12-L35-Z04-H		
	RD.. 1003		AEMR-RD1003-D20-M10-L30-Z02-H		
			AEMR-RD1003-D25-M12-L35-Z02-H		
			AEMR-RD1003-D25-M12-L35-Z03-H		
			AEMR-RD1003-D30-M16-L43-Z04-H		
			AEMR-RD1003-D32-M16-L43-Z04-H		
			AEMR-RD1003-D35-M16-L43-Z04-H		
			AEMR-RD1003-D40-M16-L43-Z05-H		
			AEMR-RD1003-D42-M16-L43-Z05-H		
			AEMR-RD1004-D25-M12-L35-Z03-H		
			AEMR-RD1004-D32-M16-L43-Z04-H		
	RD.. 1004		AEMR-RD1004-D32-M16-L43-Z04-H		
			AEMR-RD1004-D42-M16-L43-Z05-H		
			AEMR-RD12T3-D24-M12-L35-Z02-H		
RD.. 12T3		AEMR-RD12T3-D25-M12-L35-Z02-H			
		AEMR-RD12T3-D32-M16-L43-Z03-H			
		AEMR-RD12T3-D35-M16-L43-Z03-H			
		AEMR-RD12T3-D35-M16-L43-Z04-H			
		AEMR-RD12T3-D40-M16-L43-Z04-H			
		AEMR-RD12T3-D42-M16-L43-Z05-H			
RD.. 1204		AEMR-RD1204-D25-M12-L35-Z02-H			
		AEMR-RD1204-D32-M16-L43-Z03-H			
		AEMR-RD1204-D40-M16-L43-Z04-H			
		AEMR-RD1204-D42-M16-L43-Z04-H			
RD.. 1604		AEMR-RD1604-D32-M16-L43-Z02-H			
		AEMR-RD1604-D40-M16-L43-Z02-H			

ISO UCUNA UYGUNDUR.
COMPATIBLE WITH ISO INSERT.

90°	AEMRC-RD..	Uç / Insert	Takım Kodu / Tool Code
	RD.. 0501..		AEMR-RD0501-D08-W10-L100-Z01-H
			AEMR-RD0501-D10-W12-L100-Z02-H
	RD.. 08T2..		AEMR-RD08T2-D16-W16-L150-Z02
			AEMR-RD08T2-D20-W20-L150-Z02
	RD.. 0803..		AEMR-RD0803-D16-W16-L150-Z02
			AEMR-RD0803-D16-C20-L200-Z02
	RD.. 1003..		AEMR-RD0803-D20-W20-L150-Z03
			AEMRC-RD1003-D20-W20-L150-Z02
			AEMRC-RD1003-D20-C20-L160-Z02
			AEMRC-RD1003-D20-C20-L250-Z02
			AEMRC-RD1003-D21-C20-L160-Z02
			AEMRC-RD1003-D25-W25-L150-Z02
			AEMRC-RD1003-D25-C25-L160-Z02
			AEMRC-RD1003-D25-W25-L200-Z02
			AEMRC-RD1003-D25-C25-L200-Z02
			AEMRC-RD1003-D25-C25-L250-Z02
			AEMRC-RD1003-D26-C25-L160-Z02
			AEMRC-RD1003-D32-W32-L150-Z03
			AEMRC-RD1003-D32-C32-L250-Z02
			AEMRC-RD1003-D33-C32-L160-Z03
	AEMRC-RD1003-D40-W32-L150-Z04		
	AEMRC-RD1003-D40-C32-L250-Z02		
	RD.. 10T3..		AEMRC-RD10T3-D20-C20-L150-Z02
			AEMRC-RD10T3-D20-W20-L150-Z02
			AEMRC-RD10T3-D20-C20-L180-Z02-H
			AEMRC-RD10T3-D21-C20-L200-Z02-H
			AEMRC-RD10T3-D25-C25-L150-Z02
			AEMR-RD10T3-D25-C25-L180-Z02
			AEMRC-RD10T3-D25-C25-L200-Z02-H
			AEMRC-RD10T3-D25-C32-L150-Z03
			AEMRC-RD10T3-D25-W25-L150-Z02
			AEMRC-RD10T3-D26-C25-L200-Z02-H
AEMRC-RD10T3-D32-W32-L150-Z03			
AEMRC-RD10T3-D32-C32-L150-Z04			
AEMRC-RD10T3-D32-C25-L250-Z03-H			
RD.. 12T3..		AEMRC-RD12T3-D25-W25-L150-Z02	
		AEMRC-RD12T3-D25-W25-L200-Z02	
		AEMRC-RD12T3-D25-C25-L250-Z02	
		AEMRC-RD12T3-D25-C25-L300-Z02	
		AEMRC-RD12T3-D32-W32-L150-Z03	
		AEMRC-RD12T3-D32-C32-L250-Z02	
RD.. 1204..		AEMRC-RD1204-D40-W32-L150-Z04	
		AEMRC-RD12T3-D40-C32-L250-Z02	
		AEMRC-RD1204-D25-C25-L180-Z02	
		AEMRC-RD1204-D32-C32-L160-Z03	
RD.. 1604		AEMRC-RD1204-D32-C32-L200-Z02	
		AEMRC-RD1204-D32-W32-L160-Z03	
RD.. 1604		AEMRC-RD1204-D33-C32-L160-Z03	
		AEMRC-RD1204-D32-C32-L160-Z03-H	
RD.. 1604		AEMRC-RD1604-D40-W32-L150-Z02	

ISO UCUNA UYGUNDUR.
COMPATIBLE WITH ISO INSERT.

90°	AFMRC-RD..	Uç / Insert	Takım Kodu / Tool Code
	RD..0702..		AFMR-RD0702-D050-A22-Z06-H
			AFMR-RD0803-D050-A22-Z05-H
	RD..0803..		AFMRC-RD1003-D040-A16-Z04-H
			AFMR-RD1003-D040-A16-Z05-H
	RD..1003..		AFMRC-RD1003-D050-A22-Z05-H
			AFMRC-RD1003-D052-A22-Z05
			AFMRC-RD1003-D063-A22-Z06-H
			AFMRC-RD1003-D066-A22-Z07-H
			AFMRC-RD1003-D080-A27-Z07-H
			AFMRC-RD1003-D100-A32-Z08-H
	RD..1004..		AFMRC-RD1004-D063-A22-Z06-H
			AFMRC-RD1004-D080-A27-Z08-H
	RD..10T3..		AFMRC-RD10T3-D040-A16-Z05-H
			AFMRC-RD10T3-D042-A16-Z05-H
			AFMRC-RD10T3-D050-A22-Z05-H
			AFMRC-RD10T3-D052-A22-Z05-H
			AFMRC-RD10T3-D052-A22-Z06-H
			AFMRC-RD10T3-D063-A22-Z06-H
	RD..12T3..		AFMRC-RD12T3-D040-A16-Z04-H
			AFMRC-RD12T3-D050-A22-Z05-H
			AFMRC-RD12T3-D052-A22-Z05-H
			AFMRC-RD12T3-D052-A22-Z06-H
			AFMRC-RD12T3-D063-A22-Z06-H
			AFMRC-RD12T3-D066-A27-Z06-H
			AFMRC-RD12T3-D080-A27-Z07-H
			AFMRC-RD12T3-D100-A32-Z08-H
			AFMRC-RD12T3-D125-B40-Z09

ISO UCUNA UYGUNDUR.
COMPATIBLE WITH ISO INSERT.

Frezeleme Takımları / Milling Tools

-°	AFMRC-RD..	Uç / Insert	Takım Kodu / Tool Code	-°	ATSMR-RD..	Uç / Insert	Takım Kodu / Tool Code
	RD..1204..		AFMRC-RD1204-D040-A16-Z04-H		RD.. 0702..		ATSMR-RD0702-D17-W16-L90-Z02
			AFMRC-RD1204-D042-A16-Z04-H				ATSMR-RD0702-D25-W16-L90-Z03
	RD..1604..		AFMRC-RD1204-D050-A22-Z05-H		RD.. 1003..		ATSMR-RD0702-D35-W25-L100-Z05
			AFMRC-RD1204-D052-A22-Z05-H				ATSMR-RD1003-D21-W25-L100-Z02
			AFMRC-RD1204-D063-A22-Z06-H				ATSMR-RD1003-D80-W32-L165-Z06-H
			AFMRC-RD1204-D063-A22-Z07-H				ATSMR-RD12T3-D25-W25-L100-Z02
			AFMRC-RD1204-D080-A27-Z07-H				ATSMR-RD12T3-D40-W32-L100-Z03
			AFMRC-RD1204-D100-A32-Z07-H				ATSMR-RD12T3-D80-W32-L165-Z06-H
			AFMRC-RD1204-D100-A32-Z08-H				ATSMR-RD1604-D34-W32-L110-Z02
			AFMRC-RD1604-D050-A22-Z04-H				
			AFMRC-RD1604-D052-A22-Z04-H				
			AFMRC-RD1604-D063-A22-Z05-H				
			AFMRC-RD1604-D066-A22-Z05-H				
			AFMRC-RD1604-D066-A27-Z05-H				
AFMRC-RD1604-D080-A27-Z05-H							
AFMRC-RD1604-D080-A27-Z06-H							
AFMRC-RD1604-D100-A32-Z07-H							
AFMRC-RD1604-D125-B40-Z07							
AFMRC-RD1604-D160-C40-Z08							
AFMRC-RD1604-D200-C40-Z10							
 <p>ISO UCUNA UYGUNDUR. COMPATIBLE WITH ISO INSERT.</p>				 <p>ISO UCUNA UYGUNDUR. COMPATIBLE WITH ISO INSERT.</p>			
90°	AEM90-DC..	Uç / Insert	Takım Kodu / Tool Code	90°	AEM90-VC2205	Uç / Insert	Takım Kodu / Tool Code
	DC.T 0702..		AEM90-DC07-D20-M10-L30-Z02-H		VCKT 2205..		AEM90-VC2205-D32-C25-L150-Z02-H
			AEM90-DC07-D25-M12-L35-Z03-H				AEM90-VC2205-D40-C32-L150-Z03-H
	DC.T 11T3..		AEM90-DC07-D32-M16-L43-Z04-H	 <p>ISO UCUNA UYGUNDUR. COMPATIBLE WITH ISO INSERT.</p>			
			AEM90-DC07-D40-M16-L43-Z05-H				
 <p>ISO UCUNA UYGUNDUR. COMPATIBLE WITH ISO INSERT.</p>				 <p>ISO UCUNA UYGUNDUR. COMPATIBLE WITH ISO INSERT.</p>			
43°	AFM43-OF05T3	Uç / Insert	Takım Kodu / Tool Code	90°	AFM90-VC2205	Uç / Insert	Takım Kodu / Tool Code
	OF.. 05T3..		AFM43-OF05T3-D050-A22-Z05-H		VCKT 2205..		AFM90-VC2205-D050-A22-Z03-H
			AFM43-OF05T3-D063-A22-Z06-H				AFM90-VC2205-D063-A22-Z04-H
	OF.. 05T3..		AFM43-OF05T3-D080-A27-Z07-H	 <p>ISO UCUNA UYGUNDUR. COMPATIBLE WITH ISO INSERT.</p>			
			AFM43-OF05T3-D125-B40-Z09				
 <p>ISO UCUNA UYGUNDUR. COMPATIBLE WITH ISO INSERT.</p>				 <p>ISO UCUNA UYGUNDUR. COMPATIBLE WITH ISO INSERT.</p>			
43°	AFM43C-OF07	Uç / Insert	Takım Kodu / Tool Code	45°	AFM45-ON0806	Uç / Insert	Takım Kodu / Tool Code
	OF.. 0704..		AFM43C-OF07-D063-A22-Z04		ON.. 0806..		AFM45C-ON0806-D063-A22-Z08
			AFM43C-OF07-D080-A27-Z05				AFM45C-ON0806-D080-A27-Z10
	OF.. 0704..		AFM43C-OF07-D100-A32-Z06	 <p>ISO UCUNA UYGUNDUR. COMPATIBLE WITH ISO INSERT.</p>			
			AFM43C-OF07-D125-B40-Z08				
 <p>ISO UCUNA UYGUNDUR. COMPATIBLE WITH ISO INSERT.</p>				 <p>ISO UCUNA UYGUNDUR. COMPATIBLE WITH ISO INSERT.</p>			
43°	AFM88C-SN12	Uç / Insert	Takım Kodu / Tool Code	45°	AFM45.-ON0806	Uç / Insert	Takım Kodu / Tool Code
	SN.. 12..		AFM88C-SN12..-D050-A22-Z05-H		ON.. 0806..		AFM45-ON0806-D050-A22-Z04-H
			AFM88C-SN12..-D063-A22-Z06-H				AFM45-ON0806-D063-A22-Z05-H
	SN.. 12..		AFM88C-SN12..-D080-A27-Z07-H	 <p>ISO UCUNA UYGUNDUR. COMPATIBLE WITH ISO INSERT.</p>			
			AFM88C-SN12..-D100-A32-Z09-H				
 <p>ISO UCUNA UYGUNDUR. COMPATIBLE WITH ISO INSERT.</p>				 <p>ISO UCUNA UYGUNDUR. COMPATIBLE WITH ISO INSERT.</p>			
75°	AFM75C-SP12	Uç / Insert	Takım Kodu / Tool Code				
	SPKN 1203..		AFM75C-SP12-D050-A22-Z04				
			AFM75C-SP12-D063-A22-Z05				
	SPKN 1203..		AFM75C-SP12-D080-A27-Z06				
			AFM75C-SP12-D100-A32-Z07				
	SPKN 1203..		AFM75C-SP12-D125-B40-Z08				
			AFM75C-SP12-D160-C40-Z09				
 <p>ISO UCUNA UYGUNDUR. COMPATIBLE WITH ISO INSERT.</p>							
				 <p>ISO UCUNA UYGUNDUR. COMPATIBLE WITH ISO INSERT.</p>			

90°	AFM90C-TP..	Uç / Insert	Takım Kodu / Tool Code
		TP. 1603	AFM90C-TP16-D050-A22-Z04 AFM90C-TP16-D063-A22-Z06 AFM90C-TP16-D080-A27-Z07 AFM90C-TP16-D100-A32-Z08 AFM90C-TP16-D125-B40-Z08
		TP. 2204	AFM90C-TP22-D063-A22-Z05 AFM90C-TP22-D080-A27-Z06 AFM90C-TP22-D100-A32-Z07 AFM90C-TP22-D125-B40-Z08 AFM90C-TP22-D160-C40-Z09 AFM90C-TP22-D200-C60-Z12 AFM90C-TP22-D250-C60-Z15 AFM90C-TP22-D315-D60-Z18
ISO UCUNA UYGUNDUR. COMPATIBLE WITH ISO INSERT.			

-°	AEMR-RP10T3A	Uç / Insert	Takım Kodu / Tool Code
		RPMW 10T3..	AEMR-RP10T3A-D32-M16-L43-Z04-H AEMR-RP10T3A-D42-M16-L43-Z05-H
		ACHTK UCUNA UYGUNDUR. COMPATIBLE WITH ACHTK INSERT.	

-°	AFM90-AP16A	Uç / Insert	Takım Kodu / Tool Code
		AP. 1604..	AFM90-AP16A-D040-A16-Z04-H AFM90-AP16A-D050-A22-Z05-H AFM90-AP16A-D063-A22-Z06-H AFM90-AP16A-D080-A27-Z07-H AFM90-AP16A-D100-A32-Z08-H AFM90-AP16A-D125-B40-Z09
		ACHTK UCUNA UYGUNDUR. COMPATIBLE WITH ACHTK INSERT.	

45°	AFM45C-SN1206	Uç / Insert	Takım Kodu / Tool Code
		SN.. 1206..	AFM45C-SN1206-D050-A22-Z04-H AFM45C-SN1206-D050-A22-Z05-H AFM45CL-SN1206-D050-A22-Z05-H AFM45C-SN1206-D063-A22-Z06-H AFM45C-SN1206-D063-A22-Z07-H AFM45CL-SN1206-D063-A22-Z07-H AFM45C-SN1206-D080-A27-Z07-H AFM45C-SN1206-D080-A27-Z08-H AFM45CL-SN1206-D080-A27-Z08-H AFM45C-SN1206-D100-A32-Z08-H AFM45C-SN1206-D100-A32-Z10-H AFM45CL-SN1206-D100-A32-Z10-H AFM45C-SN1206-D125-B40-Z11 AFM45CL-SN1206-D125-B40-Z11 AFM45C-SN1206-D160-C40-Z12 AFM45C-SN1206-D200-C60-Z14 AFM45CL-SN1206-D200-C60-Z14
		BHLR UCUNA UYGUNDUR. COMPATIBLE WITH BHLR INSERT.	

-°	ATM-H..	Uç / Insert	Takım Kodu / Tool Code
		H23	ATM-H23-D23-C25-L100-Z02-H
		H32	ATM-H32-D32-C32-L130-Z05-H
CPT UCUNA UYGUNDUR. COMPATIBLE WITH CPT INSERT.			

-°	AEMR-RP10T3	Uç / Insert	Takım Kodu / Tool Code
		RPNX 10T3..	AEMR-RP10T3-D25-W25-L125-Z02 AEMR-RP10T3-D25-W25-L150-Z02 AEMR-RP10T3-D32-W32-L150-Z03
		CRTZT UCUNA UYGUNDUR. COMPATIBLE WITH CRTZT INSERT.	

90°	AFM90C-TP..	Uç / Insert	Takım Kodu / Tool Code
		APMT 1135..	AEM90-AP1135A-D14-C16-L150-Z01 AEM90-AP1135A-D16-C16-L150-Z02 AEM90-AP1135A-D16-C16-L200-Z02 AEM90-AP1135A-D16-C16-L250-Z02 AEM90-AP1135A-D17-C16-L180-Z02 AEM90-AP1135A-D20-C20-L150-Z03 AEM90-AP1135A-D20-C20-L200-Z02 AEM90-AP1135A-D21-C20-L180-Z02 AEM90-AP1135A-D25-C25-L200-Z03 AEM90-AP1135A-D26-C25-L250-Z02 AEM90-AP1135A-D33-C32-L250-Z02
		ACHTK UCUNA UYGUNDUR. COMPATIBLE WITH ACHTK INSERT.	

45°	AFM45C-SN..	Uç / Insert	Takım Kodu / Tool Code
		SN.. 12....	AFM45C-SN12..-D050-A22-Z04-H AFM45C-SN12..-D050-A22-Z05-H AFM45C-SN12..-D063-A22-Z06-H AFM45C-SN12..-D063-A22-Z07-H AFM45CL-SN12..-D063-A22-Z07-H AFM45C-SN12..-D080-A27-Z07-H AFM45C-SN12..-D080-A27-Z08-H AFM45CL-SN12..-D080-A27-Z08-H AFM45C-SN12..-D100-A32-Z08-H AFM45C-SN12..-D100-A32-Z10-H AFM45CL-SN12..-D100-A32-Z10-H AFM45C-SN12..-D125-B40-Z11 AFM45CL-SN12..-D125-B40-Z11 AFM45C-SN12..-D160-C40-Z12 AFM45C-SN12..-D200-C60-Z14 AFM45CL-SN12..-D200-C60-Z14
		ACHTK UCUNA UYGUNDUR. COMPATIBLE WITH ACHTK INSERT.	

-°	AFM90-AP16A	Uç / Insert	Takım Kodu / Tool Code
		AP. 1003..	AEM90-AP100-D16-C15-L150-Z02 AEM90-AP100-D21-C20-L150-Z03 AEM90-AP100-D26-C25-L150-Z04 AEM90-AP100-D33-C32-L200-Z05 AEM90-AP110-D16-C15-L150-Z02 AEM90-AP110-D21-C20-L150-Z03 AEM90-AP110-D26-C25-L150-Z04 AEM90-AP110-D33-C32-L200-Z05
		OKE UCUNA UYGUNDUR. COMPATIBLE WITH OKE INSERT.	

-°	ATM-C..	Uç / Insert	Takım Kodu / Tool Code
		C14	ATM-C14-D14-W20-L100-Z01-H ATM-C21-D18-W20-L100-Z01-H ATM-C21-D21-W25-L125-Z01-H ATM-C21-D25-W20-L125-Z01-H ATM-C21-D28-W25-L90-Z01-H ATM-C21-D38-W32-L90-Z03-H ATM-C21-D38-W32-L120-Z03-H ATM-C21-D43-W32-L90-Z03-H ATM-C30-D29-W25-L150-Z01-H
		C21	
		C30	
CPT UCUNA UYGUNDUR. COMPATIBLE WITH CPT INSERT.			

-°	ATM-C14..	Uç / Insert	Takım Kodu / Tool Code
		C14	ATM-C14-D040-A16-Z04-H
		C21	ATM-C21-D063-A22-Z04-H
DJT UCUNA UYGUNDUR. COMPATIBLE WITH DJT INSERT.			

90°	AEM90-XD11T3	Uç / Insert	Takım Kodu / Tool Code
		XD.T 11T3..	AEM90-XD11T3-D16-W16-L150-Z02 AEM90-XD11T3-D17-C16-L150-Z02 AEM90-XD11T3-D20-W20-L150-Z03 AEM90-XD11T3-D21-C20-L080-Z03-H AEM90-XD11T3-D21-C20-L150-Z03 AEM90-XD11T3-D25-W25-L150-Z04 AEM90-XD11T3-D30-W25-L120-Z04 AEM90-XD11T3-D32-W32-L150-Z04 AEM90-XD11T3-D33-C20-L080-Z04-H
		CRTZT UCUNA UYGUNDUR. COMPATIBLE WITH CRTZT INSERT.	

Frezeleme Takımları / Milling Tools

<p>90°</p> <p>AEM90-XD..</p> <p>Uç / Insert</p> <p>Takım Kodu / Tool Code</p>  <p>CRTZT UCUNA UYGUNDUR. COMPATIBLE WITH CRTZT INSERT.</p>	<p>Uç / Insert</p> <p>Takım Kodu / Tool Code</p> <p>XD.. 11T3.. AEM90-XD11T3-D20-M10-L33-Z03-H AEM90-XD11T3-D25-M12-L35-Z04-H AEM90-XD11T3-D32-M16-L35-Z05-H</p> <p>XD.. 1904.. AEM90-XD19-D32-M16-L52-Z03-H</p>	<p>-°</p> <p>AEMR-RP10T3</p> <p>Uç / Insert</p> <p>Takım Kodu / Tool Code</p>  <p>CRTZT UCUNA UYGUNDUR. COMPATIBLE WITH CRTZT INSERT.</p>	<p>Uç / Insert</p> <p>Takım Kodu / Tool Code</p> <p>RPNX 10T3.. AEMR-RP10T3-D25-M12-L35-Z02-H AEMR-RP10T3-D32-M16-L43-Z03-H</p> <p>RPNX 1204.. AEMR-RP1204-D32-M16-L43-Z03-H</p>
<p>-°</p> <p>AFMR-RP..</p> <p>Uç / Insert</p> <p>Takım Kodu / Tool Code</p>  <p>CRTZT UCUNA UYGUNDUR. COMPATIBLE WITH CRTZT INSERT.</p>	<p>Uç / Insert</p> <p>Takım Kodu / Tool Code</p> <p>RPNX 10T3.. AFMR-RP10T3-D063-A22-Z06-H AFMR-RP10T3-D080-A27-Z07-H</p> <p>RPNX 1204.. AFMR-RP1204-D040-A16-Z04-H AFMR-RP1204-D050-A22-Z05-H AFMR-RP1204-D080-A27-Z07-H</p>	<p>43°</p> <p>AFM43-OF..</p> <p>Uç / Insert</p> <p>Takım Kodu / Tool Code</p>  <p>CRTZT UCUNA UYGUNDUR. COMPATIBLE WITH CRTZT INSERT.</p>	<p>Uç / Insert</p> <p>Takım Kodu / Tool Code</p> <p>OF.. 0504 AFM43-OF0504-D050-A22-Z05-H AFM43-OF0504-D063-A22-Z06-H AFM43-OF0504-D080-A27-Z08-H</p>
<p>45°</p> <p>AFM45-SA1706</p> <p>Uç / Insert</p> <p>Takım Kodu / Tool Code</p>  <p>CRTZT UCUNA UYGUNDUR. COMPATIBLE WITH CRTZT INSERT.</p>	<p>Uç / Insert</p> <p>Takım Kodu / Tool Code</p> <p>SAKU 1706.. AFM45-SA1706-D080-A27-Z06-H AFM45-SA1706-D100-A32-Z07-H AFM45-SA1706-D125-B40-Z09</p>	<p>90°</p> <p>AFM90-SD..</p> <p>Uç / Insert</p> <p>Takım Kodu / Tool Code</p>  <p>CRTZT UCUNA UYGUNDUR. COMPATIBLE WITH CRTZT INSERT.</p>	<p>Uç / Insert</p> <p>Takım Kodu / Tool Code</p> <p>SD.. 09T3.. AFM90-SD09T3C-D050-A22-Z06-H AFM90-SD09T3C-D063-A22-Z07-H</p>
<p>90°</p> <p>AFM90-XD..</p> <p>Uç / Insert</p> <p>Takım Kodu / Tool Code</p>  <p>CRTZT UCUNA UYGUNDUR. COMPATIBLE WITH CRTZT INSERT.</p>	<p>Uç / Insert</p> <p>Takım Kodu / Tool Code</p> <p>XD.. 11T3.. AFM90-XD11T3-D050-A22-Z05-H AFM90-XD11T3-D063-A22-Z06-H</p> <p>XD.. 1904.. AFM90-XD19-D050-A22-Z04-H AFM90-XD19-D063-A22-Z05-H</p>	<p>90°</p> <p>AEM90-AD..</p> <p>Uç / Insert</p> <p>Takım Kodu / Tool Code</p>  <p>DJT UCUNA UYGUNDUR. COMPATIBLE WITH DJT INSERT.</p>	<p>Uç / Insert</p> <p>Takım Kodu / Tool Code</p> <p>ADMT 1003.. AEM90-AD1003-D16-C16-L150-Z02 AEM90-AD1003-D17-C16-L150-Z02 AEM90-AD1003-D20-C20-L200-Z03 AEM90-AD1003-D21-C20-L150-Z03 AEM90-AD1003-D21-C20-L200-Z03 AEM90-AD1003-D25-C25-L200-Z03</p> <p>ADKT 150508 AEM90-AD1003-D26-C25-L150-Z03 AEM90-AD1003-D26-C25-L200-Z03 AEM90-AD1505D-D25-W25-L150-Z02 AEM90-AD1505D-D32-W32-L150-Z03</p>
<p>90°</p> <p>AEM90-ZP13T3</p> <p>Uç / Insert</p> <p>Takım Kodu / Tool Code</p>  <p>DJT UCUNA UYGUNDUR. COMPATIBLE WITH DJT INSERT.</p>	<p>Uç / Insert</p> <p>Takım Kodu / Tool Code</p> <p>ZPMT 13T3.. (For DJT) AEM90-ZP13T3-D26-C25-L200-Z02 AEM90-ZP13T3-D26-C25-L200-Z03 AEM90-ZP13T3-D26-C25-L250-Z02 AEM90-ZP13T3-D33-C32-L200-Z03 AEM90-ZP13T3-D33-C32-L250-Z03</p>	<p>90°</p> <p>AEM90-ZP13T3</p> <p>Uç / Insert</p> <p>Takım Kodu / Tool Code</p>  <p>DJT UCUNA UYGUNDUR. COMPATIBLE WITH DJT INSERT.</p>	<p>Uç / Insert</p> <p>Takım Kodu / Tool Code</p> <p>AP.. 1003.. AEM90-AP10D-D16-M08-L30-Z02-H AEM90-AP10D-D20-M10-L30-Z03-H AEM90-AP10D-D25-M12-L35-Z03-H</p> <p>AP.. 1604.. AEM90-AP16DJ-D25-M12-L43-Z02-H AEM90-AP16DJ-D32-M16-L43-Z03-H AEM90-AP16DJ-D40-M16-L43-Z04-H</p>

90°	AFM90-AP16DJ	Uç / Insert	Takım Kodu / Tool Code
		AP.. 1604..	AFM90-AP16DJ-D050-A22-Z05-H AFM90-AP16DJ-D063-A22-Z06-H AFM90-AP16DJ-D080-A27-Z07-H
DJT UCUNA UYGUNDUR. COMPATIBLE WITH DJT INSERT.			

90°	AFM90-YC..	Uç / Insert	Takım Kodu / Tool Code
		YC.. 0907..	AFM90-YC09-D050-A22-Z04-H AFM90-YC09-D063-A22-Z05-H AFM90-YC09-D080-A27-Z06-H
DJT UCUNA UYGUNDUR. COMPATIBLE WITH DJT INSERT.			

90°	AFM90-ZN..	Uç / Insert	Takım Kodu / Tool Code
		ZN.. 1105.. ZN.. 1709..	AFM90-ZN11-D050-A22-Z07-H AFM90-ZN11-D063-A22-Z07-H AFM90-ZN17-D050-A22-Z04-H
DJT UCUNA UYGUNDUR. COMPATIBLE WITH DJT INSERT.			

90°	AFM90-ZO..	Uç / Insert	Takım Kodu / Tool Code
		ZOET 160508	AFM90-ZO16-D050-A22-Z05-H AFM90-ZO16-D063-A22-Z06-H
DJT UCUNA UYGUNDUR. COMPATIBLE WITH DJT INSERT.			

-°	AHFM-YP1003	Uç / Insert	Takım Kodu / Tool Code
			AHFM-YP1003-D16-C15-L150-Z02-F AHFM-YP1003-D16-C15-L200-Z02-F AHFM-YP1003-D16-C16-L150-Z02-F AHFM-YP1003-D17-C16-L150-Z02-F AHFM-YP1003-D17-C16-L200-Z02-F AHFM-YP1003-D20-C18-L150-Z03-F AHFM-YP1003-D20-C18-L200-Z03-F AHFM-YP1003-D20-C20-L150-Z03-F AHFM-YP1003-D21-C20-L150-Z03-F AHFM-YP1003-D21-C20-L150-Z03-H AHFM-YP1003-D21-C20-L150-Z04-F AHFM-YP1003-D21-C20-L200-Z03-F AHFM-YP1003-D21-C20-L200-Z03 AHFM-YP1003-D25-C20-L150-Z04-F AHFM-YP1003-D25-C20-L200-Z04-F AHFM-YP1003-D25-C25-L150-Z04-F AHFM-YP1003-D26-C25-L150-Z04-F AHFM-YP1003-D26-C25-L250-Z04-F AHFM-YP1003-D25-C25-L150-Z04-H AHFM-YP1003-D26-C25-L200-Z03-F AHFM-YP1003-D26-C25-L200-Z04-F AHFM-YP1003-D33-C32-L200-Z04-F AHFM-YP1003-D33-C32-L250-Z04-F AHFM-YP1003-D33-C32-L300-Z04-F
DJT UCUNA UYGUNDUR. COMPATIBLE WITH DJT INSERT.		YPHW 1003..	

-°	AHFM-EP1003	Uç / Insert	Takım Kodu / Tool Code
		EP.. 1003.. ZPMT 1003.. YPHW 1003..	AHFM-EP1003-D16-C16-L80-Z02-H AHFM-EP1003-D16-C16-L150-Z02-H AHFM-EP1003-D17-C16-L150-Z02-H AHFM-EP1003-D20-C20-L150-Z04-H AHFM-EP1003-D21-C20-L150-Z04-H AHFM-EP1003-D25-C25-L200-Z04-H AHFM-EP1003-D25-C25-L250-Z04-H
DJT UCUNA UYGUNDUR. COMPATIBLE WITH DJT INSERT.			

-°	AHFM-EP1003	Uç / Insert	Takım Kodu / Tool Code
		EP.. 1003.. ZPMT 1003.. YPHW 1003..	AHFM-EP1003-D16-M08-L23-Z02 AHFM-EP1003-D16-M08-L23-Z02-H AHFM-EP1003-D20-M10-L30-Z03 AHFM-EP1003-D20-M10-L30-Z04-H AHFM-EP1003-D25-M12-L35-Z04-H AHFM-EP1003-D32-M16-L43-Z05-H AHFM-EP1003-D35-M16-L43-Z05-H AHFM-EP1003-D42-M16-L43-Z06-H
DJT UCUNA UYGUNDUR. COMPATIBLE WITH DJT INSERT.			

-°	AHFM-EP1003	Uç / Insert	Takım Kodu / Tool Code
		EP.. 1003.. ZPMT 1003.. YPHW 1003..	AHFM-EP1003-D050-A22-Z08-H AHFM-EP1003-D063-A22-Z08-H
DJT UCUNA UYGUNDUR. COMPATIBLE WITH DJT INSERT.			

-°	AHFM-YP1003	Uç / Insert	Takım Kodu / Tool Code
		YPHW 1003..	AHFM-YP1003-D16-M08-L23-Z02-F AHFM-YP1003-D16-M08-L23-Z02-H-F AHFM-YP1003-D17-M08-L23-Z02-H-F AHFM-YP1003-D17-M08-L23-Z02-H AHFM-YP1003-D20-M10-L30-Z03-H-F AHFM-YP1003-D20-M10-L30-Z03-H AHFM-YP1003-D20-M10-L30-Z04-H AHFM-YP1003-D20-M10-L30-Z04-F AHFM-YP1003-D21-M10-L30-Z03-H-F AHFM-YP1003-D21-M10-L30-Z03-H AHFM-YP1003-D25-M12-L35-Z04-F AHFM-YP1003-D25-M12-L35-Z04-H AHFM-YP1003-D26-M12-L35-Z04-H-F AHFM-YP1003-D26-M12-L35-Z04-H-F AHFM-YP1003-D32-M16-L30-Z05-F AHFM-YP1003-D32-M16-L43-Z05-H-F AHFM-YP1003-D40-M16-L43-Z06-H-F AHFM-YP1003-D42-M16-L43-Z06-H-F
DJT UCUNA UYGUNDUR. COMPATIBLE WITH DJT INSERT.			

Frezeleme Takımları / Milling Tools

90°	AEM90-ZC1003	Uç / Insert	Takım Kodu / Tool Code		
		ZCMT 100308R	AEM90-ZC1003-D16-C14-L150-Z02 AEM90-ZC1003-D16-C14-L200-Z02 AEM90-ZC1003-D16-C15-L150-Z02 AEM90-ZC1003-D16-C16-L150-Z02 AEM90-ZC1003-D16-C16-L200-Z02 AEM90-ZC1003-D17-C16-L150-Z02 AEM90-ZC1003-D17-C16-L200-Z02 AEM90-ZC1003-D20-C18-L150-Z03 AEM90-ZC1003-D20-C18-L200-Z02 AEM90-ZC1003-D20-C20-L150-Z03 AEM90-ZC1003-D20-C18-L200-Z03 AEM90-ZC1003-D21-C20-L150-Z02 AEM90-ZC1003-D21-C20-L150-Z03 AEM90-ZC1003-D21-C20-L200-Z03 AEM90-ZC1003-D25-C20-L150-Z03 AEM90-ZC1003-D25-C20-L200-Z03 AEM90-ZC1003-D25-C25-L150-Z03 AEM90-ZC1003-D26-C25-L170-Z03 AEM90-ZC1003-D26-C25-L200-Z03 AEM90-ZC1003-D32-C25-L180-Z04 AEM90-ZC1003-D33-C32-L200-Z04		
				DJT UCUNA UYGUNDUR. COMPATIBLE WITH DJT INSERT.	
-°	AHFM-E00602	Uç / Insert	Takım Kodu / Tool Code		
		EO.. 060210 ZOMT 060210	AHFM-E00602-D10-C10-L080-Z02 AHFM-E00602-D10-C09-L120-Z02 AHFM-E00602-D10-C10-L120-Z02 new AHFM-E00602-D11-C10-L080-Z02 AHFM-E00602-D12-C12-L080-Z02 AHFM-E00602-D12-C12-L080-Z03 AHFM-E00602-D12-C11-L120-Z02 AHFM-E00602-D12-C11-L120-Z03 AHFM-E00602-D12-C12-L120-Z02 AHFM-E00602-D12-C12-L120-Z03 AHFM-E00602-D16-C16-L150-Z04		
				DJT UCUNA UYGUNDUR. COMPATIBLE WITH DJT INSERT.	
-°	AHFM-EN1004	Uç / Insert	Takım Kodu / Tool Code		
		ENMU 1004..	AHFM-EN1004-D16-M08-L23-Z02-H AHFM-EN1004-D20-M10-L30-Z03-H AHFM-EN1004-D25-M12-L35-Z03-H AHFM-EN1004-D25-M12-L35-Z04-H AHFM-EN1004-D32-M16-L43-Z05-H AHFM-EN1004-D35-M16-L43-Z05-H AHFM-EN1004-D40-M16-L43-Z05-H AHFM-EN1004-D42-M16-L43-Z05-H		
				DJT UCUNA UYGUNDUR. COMPATIBLE WITH DJT INSERT.	
-°	AHFM-SP1004	Uç / Insert	Takım Kodu / Tool Code		
		SPNW 1004..	AHFM-SP1004-D25-M12-L35-Z02-H AHFM-SP1004-D32-M16-L43-Z03-H AHFM-SP1004-D35-M16-L43-Z03-H AHFM-SP1004-D42-M16-L43-Z04-H		
				DJT UCUNA UYGUNDUR. COMPATIBLE WITH DJT INSERT.	
-°	AHFM-SD..	Uç / Insert	Takım Kodu / Tool Code		
		SD.. 0903..	AHFM-SD0903D-D050-A22-Z07-H AHFM-SD0903D-D063-A22-Z08-H		
				DJT UCUNA UYGUNDUR. COMPATIBLE WITH DJT INSERT.	
-°	AHFM-EN1004	Uç / Insert	Takım Kodu / Tool Code		
		ENMU 1004..	AHFM-EN1004-D050-A22-Z05-H AHFM-EN1004-D050-A22-Z06-H AHFM-EN1004-D052-A22-Z06-H AHFM-EN1004-D063-A22-Z06-H		
				DJT UCUNA UYGUNDUR. COMPATIBLE WITH DJT INSERT.	
-°	AHFM-SP1004	Uç / Insert	Takım Kodu / Tool Code		
		SPNW 1004..	AHFM-SP1004-D25-C25-L150-Z02 AHFM-SP1004-D32-C32-L150-Z03		
				DJT UCUNA UYGUNDUR. COMPATIBLE WITH DJT INSERT.	
-°	AHFM-SP1004	Uç / Insert	Takım Kodu / Tool Code		
		SPNW 1004..	AHFM-SP1004-D050-A22-Z05-H AHFM-SP1004-D052-A22-Z05-H AHFM-SP1004-D063-A22-Z06-H		
				DJT UCUNA UYGUNDUR. COMPATIBLE WITH DJT INSERT.	

-°	AHFM-Y00602	Uç / Insert	Takım Kodu / Tool Code
		Y0HW 0602..	AHFM-Y00602-D10-C09-L120-Z02-F AHFM-Y00602-D10-C10-L080-Z02-F AHFM-Y00602-D10-C10-L120-Z02-F AHFM-Y00602-D10-C10-L120-Z02-H-F AHFM-Y00602-D12-C11-L120-Z02-F AHFM-Y00602-D12-C11-L120-Z02-H-F AHFM-Y00602-D12-C11-L120-Z02-H AHFM-Y00602-D12-C11-L120-Z03-F AHFM-Y00602-D12-C12-L080-Z02-F AHFM-Y00602-D12-C12-L080-Z03-F AHFM-Y00602-D12-C12-L120-Z02-F AHFM-Y00602-D12-C12-L120-Z02-H AHFM-Y00602-D12-C12-L120-Z03-F AHFM-Y00602-D12-C12-L120-Z03-H
DJT UCUNA UYGUNDUR. COMPATIBLE WITH DJT INSERT.			

-°	AHFM-ZN11	Uç / Insert	Takım Kodu / Tool Code
		ZN..1105..	AEM90-ZN11-D21-C20-L150-Z03 AEM90-ZN11-D21-C20-L200-Z03 AEM90-ZN11-D25-C25-L150-Z04
DJT UCUNA UYGUNDUR. COMPATIBLE WITH DJT INSERT.			

90°	AEM90-AD1505D	Uç / Insert	Takım Kodu / Tool Code
		ADKT 150508	AEM90-AD1505D-D25-M12-L43-Z02-H AEM90-AD1505D-D32-M16-L43-Z03-H
DJT UCUNA UYGUNDUR. COMPATIBLE WITH DJT INSERT.			

95°	AEM95-XD..	Uç / Insert	Takım Kodu / Tool Code
		XDHW 0206..	AEM95-XD0206-D16-M08-L23-Z02-H AEM95-XD0206-D16-M08-L23-Z02-H-F AEM95-XD0206-D20-M10-L30-Z03-H AEM95-XD0206-D20-M10-L30-Z03-H-F AEM95-XD0206-D25-M12-L35-Z03-H AEM95-XD0206-D25-M12-L35-Z03-H-F
		XDHW 0310..	AEM95C-XD0310-D35-M16-L43-Z03-H AEM95C-XD0310-D35-M16-L43-Z03-H-F AEM95C-XD0310-D42-M16-L43-Z04-H AEM95C-XD0310-D42-M16-L43-Z04-H-F
DJT UCUNA UYGUNDUR. COMPATIBLE WITH DJT INSERT.			

-°	APMR-BNM..	Uç / Insert	Takım Kodu / Tool Code
		BNM-120-S	APMR-BNM12-D12-C12-L130
		BNM-160-S	APMR-BNM16-D16-C16-L175 APMR-BNM16-D16-C16-L200
		BNM-200-S	APMR-BNM20-D20-C20-L160 APMR-BNM20-D20-C20-L200 APMR-BNM20-D20-C20-L250
		BNM-250-S	APMR-BNM25-D25-C25-L160 APMR-BNM25-D25-C25-L200 APMR-BNM25-D25-C25-L250
DJT UCUNA UYGUNDUR. COMPATIBLE WITH DJT INSERT.			

-°	APMR-BNM..	Uç / Insert	Takım Kodu / Tool Code
		BNM 120-S	APMR-BNM12-D12-M06-L20
		BNM 160-S	APMR-BNM16-D16-M08-L23
		BNM 200-S	APMR-BNM20-D20-M10-L30
DJT UCUNA UYGUNDUR. COMPATIBLE WITH DJT INSERT.			

-°	AHFM-WD..	Uç / Insert	Takım Kodu / Tool Code
		WD.T 0503.	AHFM-WD0503D-D20-C20-L150-Z02 AHFM-WD0503D-D21-C20-L150-Z02
		WD.W 06T3..	AHFMC-WD06T3D-D26-C25-L200-Z02 AHFMC-WD06T3D-D33-C32-L200-Z03
DJT UCUNA UYGUNDUR. COMPATIBLE WITH DJT INSERT.			

-°	AHFMC-WD..	Uç / Insert	Takım Kodu / Tool Code
		WD.W 06T3..	AHFMC-WD06T3D-D042-A16-Z04-H AHFMC-WD06T3D-D050-A22-Z05-H AHFMC-WD06T3D-D052-A22-Z05-H AHFMC-WD06T3D-D063-A22-Z06-H
		WD.W 0805..	AHFMC-WD0805D-D052-A22-Z04-H AHFMC-WD0805D-D063-A22-Z05-H AHFMC-WD0805D-D066-A27-Z05-H AHFMC-WD0805D-D066-A27-Z05-H AHFMC-WD0805D-D080-A27-Z05 AHFMC-WD0805D-D100-A32-Z06
		WD.W 10X6..	AHFMC-WD10X6D-D125-B40-Z06 AHFMC-WD10X6D-D160-C40-Z07
DJT UCUNA UYGUNDUR. COMPATIBLE WITH DJT INSERT.			







-°	AHFM-W004T2	Uç / Insert	Takım Kodu / Tool Code
		W0MW 04T2..	AHFM-W004T2D-D16-C16-L150-Z02 AHFM-W004T2D-D17-C16-L150-Z02
DJT UCUNA UYGUNDUR. COMPATIBLE WITH DJT INSERT.			

90°	AFM90-AD1505D	Uç / Insert	Takım Kodu / Tool Code
		ADKT 150508	AFM90-AD1505D-D050-A22-Z05-H AFM90-AD1505D-D063-A27-Z06-H AFM90-AD1505D-D080-A27-Z08-H AFM90-AD1505D-D100-A32-Z08-H AFM90-AD1505D-D125-B40-Z09
DJT UCUNA UYGUNDUR. COMPATIBLE WITH DJT INSERT.			

-°	AHFM-WD..	Uç / Insert	Takım Kodu / Tool Code
		WD.T 0503..	AHFM-WD0503D-D20-M10-L30-Z02-H AHFM-WD0503D-D25-M12-L35-Z03-H AHFM-WD0503D-D32-M16-L43-Z04-H AHFM-WD0503D-D40-M16-L43-Z05-H
		WD.W 06T3..	AHFMC-WD06T3D-D35-M16-L43-Z03-H
		WD.W 0805..	AHFMC-WD0805D-D32-M16-L43-Z02-H
DJT UCUNA UYGUNDUR. COMPATIBLE WITH DJT INSERT.			

-°	APMR-SWB..	Uç / Insert	Takım Kodu / Tool Code
		SWB225HM-HS	APMR-SWB225-D25-M12-L35
		SWB230HM-HS	APMR-SWB230-D30-M16-L43
		SWB232HM-HS	APMR-SWB232-D32-M16-L43
DJT UCUNA UYGUNDUR. COMPATIBLE WITH DJT INSERT.			

Frezeleme Takımları / Milling Tools

42°	AFM42C-XD0806	Uç / Insert	Takım Kodu / Tool Code	45°	AFM45-SE13	Uç / Insert	Takım Kodu / Tool Code
	XDMW 0806..	AFM42C-XD0806-D063-A27-Z04-H AFM42C-XD0806-D080-A27-Z05-H AFM42C-XD0806-D100-A32-Z06-H AFM42C-XD0806-D125-B40-Z07 AFM42C-XD0806-D160-C40-Z08 AFM42C-XD0806-D200-C60-Z09			SEMT 13T3..	AFM45-SE13-D050-A22-Z04-H AFM45-SE13-D063-A22-Z05-H AFM45-SE13-D080-A27-Z06-H AFM45S-SE13-D050-A22-Z05-H AFM45S-SE13-D063-A22-Z06-H AFM45S-SE13-D080-A27-Z08-H AFM45S-SE13-D100-A32-Z10-H AFM45S-SE13-D125-B40-Z12	
DJT UCUNA UYGUNDUR. COMPATIBLE WITH DJT INSERT.				DJT UCUNA UYGUNDUR. COMPATIBLE WITH DJT INSERT.			
90°	AFM90S-SD1204	Uç / Insert	Takım Kodu / Tool Code	45°	AFM45C-XN0806	Uç / Insert	Takım Kodu / Tool Code
	SDMT 1204..	AFM90S-SD1204-D050-A22-Z04-H AFM90S-SD1204-D063-A22-Z05-H AFM90S-SD1204-D080-A27-Z06-H AFM90S-SD1204-D100-A32-Z08-H AFM90S-SD1204-D125-B40-Z10 AFM90S-SD1204-D160-C40-Z12			XNMM 0806..	AFM45C-XN0806-D063-A22-Z05 AFM45C-XN0806-D080-A27-Z06 AFM45C-XN0806-D100-A32-Z08 AFM45C-XN0806-D125-B40-Z08 AFM45C-XN0806-D160-C40-Z10 AFM45C-XN0806-D200-C60-Z12	
DJT UCUNA UYGUNDUR. COMPATIBLE WITH DJT INSERT.				DJT UCUNA UYGUNDUR. COMPATIBLE WITH DJT INSERT.			
-°	AHFM-WN..	Uç / Insert	Takım Kodu / Tool Code	-°	AHFM-WN..	Uç / Insert	Takım Kodu / Tool Code
	WN.. 0503..	AHFM-WN0503-D20-C20-L150-Z02-H AHFM-WN0503-D25-C25-L150-Z03-H			WN.. 0503..	AHFM-WN0503-D32-M16-L43-Z04-H AHFM-WN0503-D35-M16-L43-Z04-H AHFM-WN0503-D40-M16-L43-Z05-H	
DJT UCUNA UYGUNDUR. COMPATIBLE WITH DJT INSERT.				DJT UCUNA UYGUNDUR. COMPATIBLE WITH DJT INSERT.			
-°	AHFM-WN0907	Uç / Insert	Takım Kodu / Tool Code	-°	AHFM-JD1003	Uç / Insert	Takım Kodu / Tool Code
	WNMU 0706..	new AHFM-WN0503-D050-A22-Z07-H AHFM-WN0706-D050-A22-Z05-H AHFM-WN0706-D063-A22-Z06-H new AHFM-WN0706-D080-A27-Z07-H AHFM-WN0706-D080-A27-Z07-H			JDMT 1003..	AHFM-JD1003-D16-M08-L30-Z02-H AHFM-JD1003-D20-M10-L30-Z03-H	
DJT UCUNA UYGUNDUR. COMPATIBLE WITH DJT INSERT.				HTCH UCUNA UYGUNDUR. COMPATIBLE WITH HTCH INSERT.			
-°	AHFM-JD1003	Uç / Insert	Takım Kodu / Tool Code	-°	AHFM-JD1003	Uç / Insert	Takım Kodu / Tool Code
	WNMU 0907..	AHFM-WN0907-D050-A22-Z04-H AHFM-WN0907-D052-A22-Z04-H AHFM-WN0907-D063-A22-Z05-H AHFM-WN0907-D066-A27-Z05-H AHFM-WN0907-D080-A27-Z06-H AHFM-WN0907-D100-A32-Z07-H			JDMT 1003..	AHFM-JD1003-D040-A16-Z06-H AHFM-JD1003-D063-A22-Z08-H	
DJT UCUNA UYGUNDUR. COMPATIBLE WITH DJT INSERT.				DJT UCUNA UYGUNDUR. COMPATIBLE WITH DJT INSERT.			
-°	AHFM-SD1205	Uç / Insert	Takım Kodu / Tool Code	-°	AHFM-SD1205	Uç / Insert	Takım Kodu / Tool Code
	SD.. 1205..	AHFM-SD1205-D32-M16-L40-Z03-H AHFM-SD1205-D35-M16-L40-Z03-H AHFM-SD1205-D40-M16-L43-Z03-H AHFM-SD1205-D42-M16-L43-Z03-H			SD.. 1205..	AHFM-SD1205-D052-A22-Z04-H AHFM-SD1205-D052-A22-Z05-H AHFM-SD1205-D063-A22-Z05-H AHFM-SD1205-D066-A22-Z05-H AHFM-SD1205-D066-A22-Z06-H AHFM-SD1205-D080-A27-Z06-H AHFM-SD1205-D100-A32-Z08-H	
HTCH UCUNA UYGUNDUR. COMPATIBLE WITH HTCH INSERT.				HTCH UCUNA UYGUNDUR. COMPATIBLE WITH HTCH INSERT.			

°	AHFM-ED0702	Uç / Insert	Takım Kodu / Tool Code
		EDMT 0702 - JDMT 070204	AHFM-ED0702-D12-M06-L20-Z03 AHFM-ED0702-D16-M08-L25-Z04-H AHFM-ED0702-D20-M10-L30-Z05-H AHFM-ED0702-D25-M12-L30-Z06-H AHFM-ED0702-D32-M16-L30-Z08-H
HTCH UCUNA UYGUNDUR. COMPATIBLE WITH HTCH INSERT.			

90°	AEM90-AD15	Uç / Insert	Takım Kodu / Tool Code
		AD.. 1505..	AEM90-AD1505-D25-W25-L150-Z02 AEM90-AD1505-D30-W25-L150-Z03 AEM90-AD1505-D32-W32-L150-Z03
ISCR UCUNA UYGUNDUR. COMPATIBLE WITH ISCR INSERT.			

90°	AEM90-LN..	Uç / Insert	Takım Kodu / Tool Code
		LNMT 0804.	AEM90-LN08-D16-W16-L100-Z02-H AEM90-LN08-D16-W16-L150-Z02 AEM90-LN08-D20-W20-L100-Z03-H AEM90-LN08-D25-W25-L100-Z03-H AEM90-LN08-D32-W32-L110-Z05-H
		T490 LNMT 1306.	AEM90-LN1306-D32-C32-L110-Z03-H AEM90-LN1306-D32-W32-L150-Z03 AEM90-LN1306-D40-W32-L150-Z04
ISCR UCUNA UYGUNDUR. COMPATIBLE WITH ISCR INSERT.			

90°	AFM90-LN..	Uç / Insert	Takım Kodu / Tool Code
		LNMT 1106..	AFM90-LN1106-D040-A16-Z06 AFM90-LN1106-D050-A22-Z05 AFM90-LN1106-D063-A22-Z06 AFM90-LN1106-D080-A27-Z08 AFM90L-LN1106-D080-A27-Z08 AFM90-LN1106-D100-A32-Z09 AFM90L-LN1106-D100-A32-Z09 AFM90-LN1106-D125-B40-Z10
		T490 LNMT 1306.	AFM90-LN1306-D040-A16-Z04-H AFM90-LN1306-D050-A22-Z05-H AFM90-LN1306-D063-A22-Z06-H AFM90-LN1306-D080-A27-Z07-H AFM90-LN1306-D100-A32-Z08-H
		LNMT 1506..	AFM90L-LN1506-D040-A16-Z04 AFM90-LN1506-D040-A16-Z04 AFM90-LN1506-D050-A22-Z05 AFM90-LN1506-D063-A22-Z06 AFM90-LN1506-D080-A27-Z07
		T490 LNMT 1607..	AFM90-LN1607-D050-A22-Z03-H AFM90-LN1607-D063-A22-Z04-H AFM90-LN1607-D063-A22-Z06-H AFM90-LN1607-D080-A27-Z05-H AFM90-LN1607-D100-A32-Z06-H
ISCR UCUNA UYGUNDUR. COMPATIBLE WITH ISCR INSERT.			

90°	AFM90-BO..	Uç / Insert	Takım Kodu / Tool Code
		BO.. 1304..	AFM90-BO13-D040-A16-Z05-H AFM90-BO13-D050-A22-Z06-H AFM90-BO13-D063-A22-Z07-H AFM90-BO13-D080-A27-Z09-H
INGS UCUNA UYGUNDUR. COMPATIBLE WITH INGS INSERT.			

90°	AFM90-AD1505	Uç / Insert	Takım Kodu / Tool Code
		AD.. 1505..	AFM90-AD1505-D040-A16-Z04-H AFM90-AD1505-D050-A22-Z05-H AFM90-AD1505-D063-A22-Z06-H AFM90-AD1505-D080-A27-Z07-H AFM90-AD1505-D100-A32-Z08-H AFM90-AD1505-D125-B40-Z09
ISCR UCUNA UYGUNDUR. COMPATIBLE WITH ISCR INSERT.			

90°	AEM90-LN1106	Uç / Insert	Takım Kodu / Tool Code
		LNMT 1106..	AEM90-LN1106-D25-W25-L150-Z03 AEM90-LN1106-D32-W32-L150-Z04 AEM90-LN1106-D40-W32-L150-Z05
ISCR UCUNA UYGUNDUR. COMPATIBLE WITH ISCR INSERT.			

89°	AFM89-SN1305I	Uç / Insert	Takım Kodu / Tool Code
		SNMU 1305.. OXMT 0705..	AFM89-SN1305I-D040-A16-Z04-H AFM89-SN1305I-D050-A22-Z05-H AFM89-SN1305I-D063-A22-Z06-H AFM89-SN1305I-D063-A22-Z07-H AFM89-SN1305I-D080-A27-Z08-H AFM89-SN1305I-D100-A32-Z10-H
ISCR UCUNA UYGUNDUR. COMPATIBLE WITH ISCR INSERT.			

90°	AFM90-AN12	Uç / Insert	Takım Kodu / Tool Code
		ANKX 1205..	AFM90-AN12-D040-A16-Z04-H AFM90-AN12-D050-A22-Z05-H AFM90-AN12-D063-A27-Z06-H
ISCR UCUNA UYGUNDUR. COMPATIBLE WITH ISCR INSERT.			

90°	AFM90-SP1004	Uç / Insert	Takım Kodu / Tool Code
		SPMT 1004.. XPMT 1004.. QPMR 1004.. QPMT 1004.. QPMR 1004.. QPMT 1004..	AFM90-SP1004-D040-A16-Z04-H AFM90-SP1004-D050-A22-Z04-H AFM90-SP1004-D050-A22-Z06-H AFM90-SP1004-D063-A22-Z05-H AFM90-SP1004-D080-A27-Z07-H AFM90-SP1004-D100-A32-Z08-H
ISCR UCUNA UYGUNDUR. COMPATIBLE WITH ISCR INSERT.			

Frezeleme Takımları / Milling Tools

90°	AEM90-ED..	Uç / Insert	Takım Kodu / Tool Code	90°	AEM90-LN15T6	Uç / Insert	Takım Kodu / Tool Code
		EDPT 10T3.. EDPT 1404..	AEM90-ED10T3-D16-W16-L120-Z02 AEM90-ED10T3-D20-W20-L120-Z02 AEM90-ED1404-D20-W20-L150-Z02 AEM90-ED1404-D25-W25-L150-Z02 AEM90-ED1404-D30-C25-L150-Z03			LNGU 15T6..	AEM90-LN15T6-D25-W25-L150-Z02-H AEM90-LN15T6-D32-W32-L150-Z03-H AEM90-LN15T6-D40-W32-L150-Z03-H
KNMTL UCUNA UYGUNDUR. COMPATIBLE WITH KNMTL INSERT.				KNMTL UCUNA UYGUNDUR. COMPATIBLE WITH KNMTL INSERT.			
90°	AFM90-LN15T6	Uç / Insert	Takım Kodu / Tool Code	45°	AFM45C-HN0905	Uç / Insert	Takım Kodu / Tool Code
		LNGU 15T6..	AFM90-LN15T6-D050-A22-Z05-H AFM90-LN15T6-D063-A22-Z06-H AFM90-LN15T6-D080-A27-Z07-H			HN.. 0905..	AFM45C-HN0905-D063-A22-Z07 AFM45C-HN0905-D080-A27-Z09 AFM45C-HN0905-D100-A32-Z11 AFM45C-HN0905-D125-B40-Z13 AFM45CL-HN0905-D125-B40-Z10 AFM45C-HN0905-D160-C40-Z15
KNMTL UCUNA UYGUNDUR. COMPATIBLE WITH KNMTL INSERT.				KNMTL UCUNA UYGUNDUR. COMPATIBLE WITH KNMTL INSERT.			
-°	AHFM-XD0904	Uç / Insert	Takım Kodu / Tool Code	-°	AHFM-S00803	Uç / Insert	Takım Kodu / Tool Code
		XD.. 0904..	AHFM-XD0904-D050-A22-Z05-H AHFM-XD0904-D063-A22-Z06-H			SOMW 0803..	AHFM-S00803-D20-W20-L150-Z02 AHFM-S00803-D25-W25-L150-Z03 AHFM-S00803-D32-W32-L150-Z04 AHFM-S00803-D35-W32-L160-Z04
KNMTL UCUNA UYGUNDUR. COMPATIBLE WITH KNMTL INSERT.				KPTK UCUNA UYGUNDUR. COMPATIBLE WITH KPTK INSERT.			
-°	AHFM-S00803	Uç / Insert	Takım Kodu / Tool Code	-°	AEM90-AP..	Uç / Insert	Takım Kodu / Tool Code
		SOMW 0803..	AHFM-S00803-D20-M10-L30-Z02-H AHFM-S00803-D25-M12-L35-Z03-H AHFM-S00803-D32-M16-L43-Z03-H AHFM-S00803-D32-M16-L43-Z04-H AHFM-S00803-D40-M16-L43-Z04-H AHFM-S00803-D40-M16-L43-Z05-H			APMT 0602.. APMT 0903..	AEM90-AP06-D10-C10-L120-Z02 AEM90-AP06-D12-C12-L120-Z02 AEM90-AP0903-D12-C16-L080-Z01-H AEM90-AP0903-D16-C16-L090-Z02 AEM90-AP0903-D16-C16-L150-Z02 AEM90-AP0903-D17-C16-L150-Z02 AEM90-AP0903-D18-C16-L090-Z02-H AEM90-AP0903-D20-C20-L110-Z03 AEM90-AP0903-D20-C20-L150-Z02 AEM90-AP0903-D20-C20-L200-Z02 AEM90-AP0903-D21-C20-L150-Z02 AEM90-AP0903-D25-C25-L120-Z03 AEM90-AP0903-D25-C25-L150-Z03 AEM90-AP0903-D25-C25-L200-Z02
KPTK UCUNA UYGUNDUR. COMPATIBLE WITH KPTK INSERT.				KRLY UCUNA UYGUNDUR. COMPATIBLE WITH KRLY INSERT.			
90°	AHFM-S00803	Uç / Insert	Takım Kodu / Tool Code	90°	AEM90-AP11KR..	Uç / Insert	Takım Kodu / Tool Code
		APMT 0903..	AEM90-AP0903-D20-M12-L35-Z03 AEM90-AP0903-D25-M12-L35-Z03			AP.. 11T3..	new AEM90-AP11KR-D16-W16-L090-Z02-H new AEM90-AP11KR-D20-W20-L100-Z02-H new AEM90-AP11KR-D20-W20-L100-Z03-H new AEM90-AP11KR-D22-W20-L115-Z03-H AEM90-AP11KR-D25-W25-L115-Z03-H AEM90-AP11KR-D32-W32-L125-Z04-H AEM90-AP11KR-D25-C25-L180-Z04
KRLY UCUNA UYGUNDUR. COMPATIBLE WITH KRLY INSERT.				KRLY UCUNA UYGUNDUR. COMPATIBLE WITH KRLY INSERT.			
90°	AEM90-XE19..	Uç / Insert	Takım Kodu / Tool Code	90°	AEM90-AP11KR..	Uç / Insert	Takım Kodu / Tool Code
		XE.. 19M5..	AEM90-XE19-D25-M12-L43-Z02-H-A AEM90-XE19-D32-M16-L43-Z03-H-A			AP.. 11T3..	new AEM90-AP11KR-D16-W16-L090-Z02-H new AEM90-AP11KR-D20-W20-L100-Z02-H new AEM90-AP11KR-D20-W20-L100-Z03-H new AEM90-AP11KR-D22-W20-L115-Z03-H AEM90-AP11KR-D25-W25-L115-Z03-H AEM90-AP11KR-D32-W32-L125-Z04-H AEM90-AP11KR-D25-C25-L180-Z04
KRLY UCUNA UYGUNDUR. COMPATIBLE WITH KRLY INSERT.				KRLY UCUNA UYGUNDUR. COMPATIBLE WITH KRLY INSERT.			

90°	AEM90-LN1006	Uç / Insert	Takım Kodu / Tool Code
		LN.X 1006..	AEM90-LN1006-D16-W16-L120-Z01-H AEM90-LN1006-D16-W16-L150-Z01 AEM90-LN1006-D18-W16-L120-Z02-H AEM90-LN1006-D20-W20-L120-Z02-H AEM90-LN1006-D20-W20-L150-Z02 AEM90-LN1006-D25-W25-L120-Z03-H AEM90-LN1006-D25-W25-L150-Z03 AEM90-LN1006-D32-W32-L120-Z04-H AEM90-LN1006-D32-W32-L150-Z04
KRLY UCUNA UYGUNDUR. COMPATIBLE WITH KRLY INSERT.			

90°	AFM90-AP16KR	Uç / Insert	Takım Kodu / Tool Code
		AP. 1604..	AFM90-AP16KR-D040-A16-Z04-H AFM90-AP16KR-D050-A22-Z05-H AFM90-AP16KR-D063-A22-Z06-H AFM90-AP16KR-D080-A27-Z07-H AFM90-AP16KR-D100-A32-Z08-H AFM90-AP16KR-D125-B40-Z10-H
KRLY UCUNA UYGUNDUR. COMPATIBLE WITH KRLY INSERT.			

-°	AHFM-LN..	Uç / Insert	Takım Kodu / Tool Code
		LNMX 0603..	AHFM-LN06-D20-C20-L130-Z03-H AHFM-LN06-D20-C20-L160-Z03-H AHFM-LN06-D33-C32-L200-Z05-H
KRLY UCUNA UYGUNDUR. COMPATIBLE WITH KRLY INSERT.			

-°	AHFM-WN..	Uç / Insert	Takım Kodu / Tool Code
		WNMX 0603..	AHFM-WN0603-D16-C16-L110-Z02-H AHFM-WN0603-D16-C16-L150-Z02-H AHFM-WN0603-D17-C16-L150-Z02-H AHFM-WN0603-D20-C20-L150-Z02-H AHFM-WN0603-D20-C20-L200-Z02-H AHFM-WN0603-D21-C20-L150-Z02-H
		WNMX 09T3..	AHFM-WN09T3-D25-W25-L120-Z02-H AHFML-WN09T3-D25-W25-L120-Z02-H AHFM-WN09T3-D25-C25-L200-Z02 AHFM-WN09T3-D32-W32-L120-Z03-H AHFM-WN09T3-D32-W32-L200-Z03-H AHFM-WN09T3-D35-W32-L200-Z04-H AHFM-WN09T3-D40-W32-L120-Z04-H AHFM-WN09T3-D40-C32-L200-Z04
		WNMX 1305..	AHFM-WN1305-D32-C32-L150-Z02-H AHFM-WN1305-D32-C32-L200-Z02-H AHFM-WN1305-D40-C32-L200-Z03-H
KRLY UCUNA UYGUNDUR. COMPATIBLE WITH KRLY INSERT.			

-°	AHFM-WN09T3	Uç / Insert	Takım Kodu / Tool Code
		WNMX 09T3..	AHFM-WN09T3-D32-M16-L40-Z03-H AHFM-WN09T3-D35-M16-L40-Z04-H AHFM-WN09T3-D40-M16-L40-Z04-H
KRLY UCUNA UYGUNDUR. COMPATIBLE WITH KRLY INSERT.			

90°	AHFM-LN..	Uç / Insert	Takım Kodu / Tool Code
		LN.. 0603..	AHFM-LN06-D040-A16-Z06-H AHFM-LN06-D050-A22-Z07-H AHFM-LN06-D052-A22-Z08-H AHFM-LN06-D063-A22-Z08-H
KRLY UCUNA UYGUNDUR. COMPATIBLE WITH KRLY INSERT.			

-°	AHFM-WN09T3	Uç / Insert	Takım Kodu / Tool Code
		WNMX 09T3..	AHFM-WN09T3-D040-A16-Z04-H AHFML-WN09T3-D040-A16-Z04-H AHFM-WN09T3-D050-A22-Z05-H AHFML-WN09T3-D050-A22-Z05-H AHFM-WN09T3-D063-A22-Z06
KRLY UCUNA UYGUNDUR. COMPATIBLE WITH KRLY INSERT.			

88°	AFM88C-SN1206	Uç / Insert	Takım Kodu / Tool Code
		SN.. 1206..	AFM88C-SN1206-D040-A16-Z04-H AFM88C-SN1206-D050-A22-Z05-H AFM88C-SN1206-D063-A22-Z06-H AFM88C-SN1206-D080-A27-Z07-H AFM88C-SN1206-D100-A32-Z09-H AFM88C-SN1206-D125-B40-Z10
KRLY UCUNA UYGUNDUR. COMPATIBLE WITH KRLY INSERT.			

45°	AFM45C-SN1206	Uç / Insert	Takım Kodu / Tool Code
		SN.. 1206..	AFM45C-SN1206-D050-A22-Z04-H AFM45CL-SN1206-D050-A22-Z05-H AFM45C-SN1206-D050-A22-Z05-H AFM45C-SN1206-D063-A22-Z06-H AFM45C-SN1206-D063-A22-Z07-H AFM45CL-SN1206-D063-A22-Z07-H AFM45C-SN1206-D080-A27-Z07-H AFM45C-SN1206-D080-A27-Z08-H AFM45CL-SN1206-D080-A27-Z08-H AFM45C-SN1206-D100-A32-Z08-H AFM45C-SN1206-D100-A32-Z10-H AFM45CL-SN1206-D100-A32-Z10-H AFM45C-SN1206-D125-B40-Z11 AFM45CL-SN1206-D125-B40-Z11 AFM45C-SN1206-D160-C40-Z12 AFM45CL-SN1206-D160-C40-Z12 AFM45C-SN1206-D200-C60-Z14 AFM45CL-SN1206-D200-C60-Z14
KRLY UCUNA UYGUNDUR. COMPATIBLE WITH KRLY INSERT.			

45°	AFM45-SE14M4	Uç / Insert	Takım Kodu / Tool Code
		SE.. 14M4..	AFM45-SE14M4-D063-A22-Z04-H AFM45-SE14M4-D080-A27-Z05-H AFM45-SE14M4-D100-A32-Z05-H AFM45-SE14M4-D125-B40-Z06 AFM45-SE14M4-D160-C40-Z07
KRLY UCUNA UYGUNDUR. COMPATIBLE WITH KRLY INSERT.			

Frezeleme Takımları / Milling Tools

90°	AFM90-XE19	Uç / Insert	Takım Kodu / Tool Code	90°	AFM90-SD..	Uç / Insert	Takım Kodu / Tool Code
		XE.. 19M5..	AFM90-XE19-D040-A16-Z03-H AFM90-XE19-D050-A22-Z04-H AFM90-XE19-D063-A22-Z05-H			SD.. 09M4..	AFM90-SD09M4-D040-A16-Z04-H AFM90-SD09M4-D050-A22-Z05-H AFM90-SD09M4-D063-A22-Z06-H AFM90-SD09M4-D063-A27-Z06-H AFM90-SD09M4-D080-A27-Z07-H
KRLY UCUNA UYGUNDUR. COMPATIBLE WITH KRLY INSERT.				KRLY UCUNA UYGUNDUR. COMPATIBLE WITH KRLY INSERT.			
90°	AFM90-WN..	Uç / Insert	Takım Kodu / Tool Code	90°	AFM90-SD..	Uç / Insert	Takım Kodu / Tool Code
		WNGX 080608	AFM90-WN0806K-D050-A22-Z05-H AFM90-WN0806K-D063-A22-Z06-H AFM90-WN0806K-D080-A27-Z07-H AFM90-WN0806K-D100-A32-Z08-H AFM90-WN0806K-D125-A40-Z11-H				
KRLY UCUNA UYGUNDUR. COMPATIBLE WITH KRLY INSERT.				KRLY UCUNA UYGUNDUR. COMPATIBLE WITH KRLY INSERT.			
90°	AEM90-BD11T3	Uç / Insert	Takım Kodu / Tool Code	90°	AFM90-SD..	Uç / Insert	Takım Kodu / Tool Code
		BDMT 11T3..	AEM90-BD11T3-D16-M08-L25-Z02-H AEM90-BD11T3-D25-M12-L35-Z04-H AEM90-BD11T3-D32-M16-L40-Z05-H				
KYCR UCUNA UYGUNDUR. COMPATIBLE WITH KYCR INSERT.				BDMT 11T3..			
90°	AFM90-BD..	Uç / Insert	Takım Kodu / Tool Code	90°	AFM90-SD..	Uç / Insert	Takım Kodu / Tool Code
		BDMT 11T3.. BDMT 1704..	AFM90-BD0703-D032-A16-Z08-H AFM90-BD11T3-D040-A16-Z04-H AFM90-BD11T3-D040-A16-Z05-H AFM90-BD11T3-D050-A22-Z05-H AFM90-BD11T3-D063-A22-Z06-H AFM90-BD1704-D050-A22-Z04-H AFM90-BD1704-D050-A22-Z05-H AFM90-BD1704-D063-A22-Z06-H AFM90-BD11T3-D080-A27-Z09-H AFM90-BD1704-D080-A27-Z06-H AFM90-BD1704-D080-A27-Z07-H AFM90-BD1704-D100-A32-Z07-H				
KYCR UCUNA UYGUNDUR. COMPATIBLE WITH KYCR INSERT.				BDMT 1704..			
90°	AEM90-LO..	Uç / Insert	Takım Kodu / Tool Code	90°	AFM90-SD..	Uç / Insert	Takım Kodu / Tool Code
		LOMU 1004..	AEM90-LO10-D16-W16-L100-Z02 AEM90-LO10-D16-W16-L160-Z02 AEM90-LO10-D20-W20-L130-Z03 AEM90-LO10-D25-W25-L150-Z03 AEM90-LO10-D32-W32-L150-Z04				
KYCR UCUNA UYGUNDUR. COMPATIBLE WITH KYCR INSERT.				KYCR UCUNA UYGUNDUR. COMPATIBLE WITH KYCR INSERT.			
90°	AEM90-LO..	Uç / Insert	Takım Kodu / Tool Code	°	AHFM-L003	Uç / Insert	Takım Kodu / Tool Code
		RPMT 10T3..	AEMR-RP10T3K-D20-C20-L160-Z02 AEMR-RP10T3K-D25-C25-L160-Z03			LOGU 0303..	AHFM-L003-D16-C15-L160-Z02 AHFM-L003-D16-C16-L100-Z02-F AHFM-L003-D16-C16-L100-Z02 AHFM-L003-D16-C16-L130-Z02-H AHFM-L003-D16-C16-L160-Z02 AHFM-L003-D16-C16-L160-Z02-H AHFM-L003-D16-C16-L220-Z02-H AHFM-L003-D17-C16-L180-Z02 AHFM-L003-D20-C20-L130-Z03 AHFM-L003-D20-C20-L130-Z03-H AHFM-L003-D20-C20-L160-Z03 AHFM-L003-D20-C20-L160-Z03-H AHFM-L003-D21-C20-L150-Z03-H AHFM-L003-D21-C20-L200-Z03 AHFM-L003-D21-C20-L200-Z03-H AHFM-L003-D25-C25-L140-Z04-F AHFM-L003-D25-C25-L140-Z04 AHFM-L003-D25-C25-L180-Z04 AHFM-L003-D26-C25-L250-Z04 AHFM-L003-D32-C32-L200-Z05 AHFM-L003-D33-C32-L250-Z05
KYCR UCUNA UYGUNDUR. COMPATIBLE WITH KYCR INSERT.				KYCR UCUNA UYGUNDUR. COMPATIBLE WITH KYCR INSERT.			
°	AEMR-RP10T3K	Uç / Insert	Takım Kodu / Tool Code	°	AHFM-L003	Uç / Insert	Takım Kodu / Tool Code
		RPMT 10T3..	AEMR-RP10T3K-D32-M16-L43-Z04-H AEMR-RP10T3K-D42-M16-L43-Z05-H				
KYCR UCUNA UYGUNDUR. COMPATIBLE WITH KYCR INSERT.				KYCR UCUNA UYGUNDUR. COMPATIBLE WITH KYCR INSERT.			

-°	AHFM-L003	Uç / Insert	Takım Kodu / Tool Code
		LOGU 0303..	AHFM-L003-D20-M10-L30-Z04-H-F AHFM-L003-D25-M12-L35-Z04-H-F AHFM-L003-D25-M12-L35-Z04-H AHFM-L003-D32-M16-L40-Z05-H-F AHFM-L003-D32-M16-L40-Z05-H AHFM-L003-D32-M16-L40-Z06-H-F AHFM-L003-D32-M16-L40-Z06-H AHFM-L003-D35-M16-L40-Z05-H AHFM-L003-D35-M16-L40-Z06-H AHFM-L003-D42-M16-L40-Z05-H AHFM-L003-D42-M16-L40-Z06-H
KYCR UCUNA UYGUNDUR. COMPATIBLE WITH KYCR INSERT.			

-°	AHFM-L003	Uç / Insert	Takım Kodu / Tool Code
		LOGU 0303..	AHFM-L003-D040-A16-Z06-H AHFM-L003-D050-A22-Z07-H AHFM-L003-D063-A22-Z09-H
KYCR UCUNA UYGUNDUR. COMPATIBLE WITH KYCR INSERT.			

-°	AHFM-LP0102	Uç / Insert	Takım Kodu / Tool Code
		LPGT 0102.	AHFM-LP0102-D10-C09-L120-Z02 AHFM-LP0102-D10-C10-L120-Z02 AHFM-LP0102-D12-C11-L120-Z02 AHFM-LP0102-D12-C12-L120-Z02
KYCR UCUNA UYGUNDUR. COMPATIBLE WITH KYCR INSERT.			

-°	AHFM-S01004	Uç / Insert	Takım Kodu / Tool Code
		SOMT 1004..	AHFM-S01004-D32-M16-L40-Z03-H AHFM-S01004-D35-M16-L40-Z03-H AHFM-S01004-D40-M16-L40-Z04-H AHFM-S01004-D42-M16-L40-Z04-H
KYCR UCUNA UYGUNDUR. COMPATIBLE WITH KYCR INSERT.			

-°	AHFM-S01004	Uç / Insert	Takım Kodu / Tool Code
		SOMT 1004..	AHFM-S01004-D050-A22-Z05-H AHFM-S01004-D052-A22-Z05-H AHFM-S01004-D063-A22-Z06-H AHFM-S01004-D080-A27-Z07-H
KYCR UCUNA UYGUNDUR. COMPATIBLE WITH KYCR INSERT.			

66°	AFM66-PN0905	Uç / Insert	Takım Kodu / Tool Code
		PNMU 0905..	AFM66-PN0905-D050-A22-Z05 AFM66-PN0905-D063-A22-Z06 AFM66-PN0905-D080-A27-Z08 AFM66-PN0905-D100-A32-Z10 AFM66-PN0905-D125-B40-Z12
KYCR UCUNA UYGUNDUR. COMPATIBLE WITH KYCR INSERT.			

88°	AFM88-SN1305	Uç / Insert	Takım Kodu / Tool Code
		SNMU 1305..	AFM88-SN1305-D050-A22-Z04 AFM88-SN1305-D050-A22-Z05 AFM88-SN1305-D063-A22-Z05 AFM88-SN1305-D063-A22-Z07 AFM88-SN1305-D063-A22-Z07 AFM88-SN1305-D080-A27-Z06 AFM88-SN1305-D080-A27-Z09 AFM88-SN1305-D100-A32-Z07 AFM88-SN1305-D100-A32-Z11 AFM88-SN1305-D125-B40-Z13
KYCR UCUNA UYGUNDUR. COMPATIBLE WITH KYCR INSERT.			

90°	AFM90-LO	Uç / Insert	Takım Kodu / Tool Code
		LOMU 1004..	AFM90-LO10-D040-A16-Z05-H AFM90-LO10-D050-A22-Z05-H AFM90-LO10-D063-A22-Z06-H
		LOMU 1505..	AFM90-LO1505-D050-A22-Z04-H AFM90-LO1505-D063-A22-Z05-H
KYCR UCUNA UYGUNDUR. COMPATIBLE WITH KYCR INSERT.			

90°	AFM90-WN0806	Uç / Insert	Takım Kodu / Tool Code
		WNMX 080608	AFM90-WN0806-D050-A16-Z04-H AFM90-WN0806-D063-A22-Z05-H AFM90-WN0806-D080-A27-Z07-H
KYCR UCUNA UYGUNDUR. COMPATIBLE WITH KYCR INSERT.			

88°	AFM88C-SN1204	Uç / Insert	Takım Kodu / Tool Code
		SNCN 1204..	AFM88C-SN1204-D050-A22-Z05 AFM88C-SN1204-D063-A22-Z06 AFM88C-SN1204-D080-A27-Z07 AFM88C-SN1204-D100-A32-Z08 AFM88C-SN1204-D125-B40-Z11
KYCR UCUNA UYGUNDUR. COMPATIBLE WITH KYCR INSERT.			

90°	AEM90-AP16L	Uç / Insert	Takım Kodu / Tool Code
		AP. 1604..	AEM90-AP16L-D25-C25-L120-Z02-H AEM90-AP16L-D25-C25-L150-Z02 AEM90-AP16L-D25-C25-L200-Z02 AEM90-AP16L-D25-C25-L250-Z02 AEM90-AP16L-D30-W25-L120-Z03-H AEM90-AP16L-D32-C32-L120-Z03-H AEM90-AP16L-D32-C32-L150-Z03 AEM90-AP16L-D32-C32-L200-Z03 AEM90-AP16L-D32-C32-L250-Z03 AEM90-AP16L-D40-C32-L120-Z04-H AEM90-AP16L-D40-C32-L150-Z04 AEM90-AP16L-D40-C32-L200-Z04 AEM90-AP16L-D40-C32-L250-Z04
LMN UCUNA UYGUNDUR. COMPATIBLE WITH LMN INSERT.			

90°	AEM90-AP1705	Uç / Insert	Takım Kodu / Tool Code
		AP. 1604..	AEM90-AP1705-D25-C25-L120-Z02 AEM90-AP1705-D26-C25-L200-Z02 AEM90-AP1705-D26-C25-L250-Z02 AEM90-AP1705-D26-C25-L300-Z02 AEM90-AP1705-D28-W25-L075-Z02 AEM90-AP1705-D32-C25-L150-Z03 AEM90-AP1705-D33-C32-L250-Z03 AEM90-AP1705-D33-C32-L300-Z02
LMN UCUNA UYGUNDUR. COMPATIBLE WITH LMN INSERT.			

Frezeleme Takımları / Milling Tools

90°	AEM90-AP16L	Uç / Insert	Takım Kodu / Tool Code	90°	AFM90-AP16L	Uç / Insert	Takım Kodu / Tool Code
	AP..1604..	AEM90-AP16L-D25-M12-L43-Z02-H AEM90-AP16L-D32-M16-L43-Z03-H AEM90-AP16L-D40-M16-L43-Z04-H			AP..1604..	AFM90-AP16L-D050-A22-Z05-H AFM90-AP16L-D063-A22-Z06-H AFM90-AP16L-D080-A27-Z07-H	
LMN UCUNA UYGUNDUR. COMPATIBLE WITH LMN INSERT.				LMN UCUNA UYGUNDUR. COMPATIBLE WITH LMN INSERT.			
43°	AFM43C-OD0605	Uç / Insert	Takım Kodu / Tool Code	45°	AFM45C-SN..	Uç / Insert	Takım Kodu / Tool Code
	OD..0605..	AFM43C-OD0605-D080-A27-Z06-H AFM43C-OD0605-D100-A32-Z07-H AFM43C-OD0605-D125-B40-Z08			SN..12....	AFM45C-SN12..-D050-A22-Z04-H AFM45C-SN12..-D050-A22-Z05-H AFM45C-SN12..-D063-A22-Z06-H AFM45C-SN12..-D063-A22-Z07-H AFM45C-SN12..-D080-A27-Z07-H AFM45C-SN12..-D080-A27-Z08-H AFM45C-SN12..-D080-A27-Z08-H AFM45C-SN12..-D100-A32-Z08-H AFM45C-SN12..-D100-A32-Z10-H AFM45C-SN12..-D100-A32-Z10-H AFM45C-SN12..-D125-B40-Z11 AFM45C-SN12..-D125-B40-Z11 AFM45C-SN12..-D160-C40-Z12 AFM45C-SN12..-D200-C60-Z14 AFM45C-SN12..-D200-C60-Z14	
LMN UCUNA UYGUNDUR. COMPATIBLE WITH LMN INSERT.				LMN UCUNA UYGUNDUR. COMPATIBLE WITH LMN INSERT.			
90°	AEM90-A01236	Uç / Insert	Takım Kodu / Tool Code	90°	AEM90-A01236	Uç / Insert	Takım Kodu / Tool Code
	A0..1236..	AEM90-A01236-D16-W16-L150-Z02 AEM90-A01236-D16-C16-L160-Z02-H AEM90-A01236-D17-C16-L150-Z02-H AEM90-A01236-D18-C16-L160-Z02-H AEM90-A01236-D20-C20-L160-Z03-H AEM90-A01236-D20-C20-L100-Z02 AEM90-A01236-D21-C20-L220-Z03-H AEM90-A01236-D22-C20-L160-Z03-H AEM90-A01236-D25-C25-L115-Z02 AEM90-A01236-D25-C25-L160-Z04-H AEM90-A01236-D25-W25-L150-Z03 AEM90-A01236-D26-C25-L150-Z04-H AEM90-A01236-D26-C25-L160-Z04-H AEM90-A01236-D32-W32-L150-Z04 AEM90-A01236-D32-C32-L160-Z05-H			A0..1236..	AEM90-A01236-D16-M08-L30-Z02 AEM90-A01236-D20-M10-L35-Z03	
MTSBH UCUNA UYGUNDUR. COMPATIBLE WITH MTSBH INSERT.				MTSBH UCUNA UYGUNDUR. COMPATIBLE WITH MTSBH INSERT.			
90°	AFM90-AO..	Uç / Insert	Takım Kodu / Tool Code	90°	AEM90-LO..	Uç / Insert	Takım Kodu / Tool Code
	A0..1236.. A0..1848..	AFM90-A01236-D050-A22-Z05-H AFM90-A01848-D050-A22-Z05-H AFM90-A01848-D063-A22-Z06-H			LOGU 0904..	AEM90-L009-D16-C16-L160-Z02-H AEM90-L009-D18-C16-L160-Z02-H AEM90-L009-D20-C20-L160-Z03-H AEM90-L009-D20-W20-L100-Z03-H AEM90-L009-D22-C20-L160-Z03-H AEM90-L009-D25-C25-L160-Z04-H AEM90-L009-D28-C25-L160-Z04-H AEM90-L009-D25-W25-L091-Z03-H AEM90-L009-D32-C32-L160-Z05-H AEM90-L01207-D32-W32-L105-Z03-H AEM90-L01207-D40-W32-L200-Z04-H	
MTSBH UCUNA UYGUNDUR. COMPATIBLE WITH MTSBH INSERT.				MTSBH UCUNA UYGUNDUR. COMPATIBLE WITH MTSBH INSERT.			
90°	AFM90-LO 0904 / 1207	Uç / Insert	Takım Kodu / Tool Code	90°	AEMR-RP..	Uç / Insert	Takım Kodu / Tool Code
	LOGU 0904.. LOGU 1207..	AFM90-L00904-D040-A16-Z06-H AFM90-L00904-D050-A22-Z05-H AFM90-L00904-D050-A22-Z07-H AFM90-L00904-D063-A22-Z06-H AFM90-L01207-D040-A16-Z04-H AFM90-L01207-D050-A22-Z05-H AFM90-L01207-D063-A22-Z05-H AFM90-L01207-D063-A22-Z06-H AFM90-L01207-D080-A27-Z07-H AFM90-L01207-D100-A32-Z07-H			RPMT 08T2.. RPMT 10T3.. RPMT 1204.. RPMT 1606..	AEMR-RP08T2M-D20-W20-L150-Z02-H AEMR-RP08T2M-D25-W25-L200-Z03-H AEMR-RP10T3M-D25-W25-L200-Z02-H AEMR-RP10T3M-D32-W32-L200-Z03-H AEMR-RP1204M-D25-C25-L180-Z02 AEMR-RP1204M-D25-C25-L180-Z02-H AEMR-RP1204M-D32-W32-L150-Z03-H AEMR-RP1204M-D32-W32-L200-Z03-H AEMR-RP1204M-D36-C25-L160-Z03 AEMR-RP1606M-D40-W32-L150-Z02-H AEMR-RP1606M-D40-W32-L200-Z02-H	
MTSBH UCUNA UYGUNDUR. COMPATIBLE WITH MTSBH INSERT.				MTSBH UCUNA UYGUNDUR. COMPATIBLE WITH MTSBH INSERT.			
-°	ADM90-QO..	Uç / Insert	Takım Kodu / Tool Code	-°	ADM90-QO..	Uç / Insert	Takım Kodu / Tool Code
	QOMT 1035R-M2 QOMT 1342R-M2 QOMT 1651R-M2 QOMT 2062R-M2	ADM90-Q010-D20-C20-L130-Z0204-H ADM90-Q010-D20-C20-L185-Z0204-H ADM90-Q013-D25-C25-L140-Z0204-H ADM90-Q013-D25-C25-L220-Z0204-H ADM90-Q016-D32-C32-L150-Z0204-H ADM90-Q016-D32-C32-L200-Z02-H ADM90-Q016-D32-C32-L230-Z0204-H ADM90-Q016-D32-C32-L230-Z02-H ADM90-Q020-D40-C32-L160-Z0204 ADM90-Q020-D40-C32-L240-Z0204			QOMT 1035R-M2 QOMT 1342R-M2 QOMT 1651R-M2 QOMT 2062R-M2	ADM90-Q010-D20-C20-L130-Z0204-H ADM90-Q010-D20-C20-L185-Z0204-H ADM90-Q013-D25-C25-L140-Z0204-H ADM90-Q013-D25-C25-L220-Z0204-H ADM90-Q016-D32-C32-L150-Z0204-H ADM90-Q016-D32-C32-L200-Z02-H ADM90-Q016-D32-C32-L230-Z0204-H ADM90-Q016-D32-C32-L230-Z02-H ADM90-Q020-D40-C32-L160-Z0204 ADM90-Q020-D40-C32-L240-Z0204	
MTSBH UCUNA UYGUNDUR. COMPATIBLE WITH MTSBH INSERT.				MTSBH UCUNA UYGUNDUR. COMPATIBLE WITH MTSBH INSERT.			

-°	AEMR-RP..	Uç / Insert	Takım Kodu / Tool Code
		RPMT 08T2..	AEMR-RP08T2M-D20-M10-L30-Z02-H
		RPMT 10T3..	AEMR-RP10T3M-D25-M12-L35-Z02-H AEMR-RP10T3M-D32-M16-L43-Z03-H
		RPMT 1204	AEMR-RP1204M-D32-M16-L43-Z03-H AEMR-RP1204M-D40-M16-L43-Z04-H
MTSBH UCUNA UYGUNDUR. COMPATIBLE WITH MTSBH INSERT.			

-°	AHFMC-JD1204	Uç / Insert	Takım Kodu / Tool Code
		JDMW 1204..	AHFMC-JD1204-D32-C32-L150-Z02 AHFMC-JD1204-D32-C32-L200-Z02 AHFMC-JD1204-D35-C32-L200-Z02 AHFMC-JD1204-D35-C32-L250-Z02
MTSBH UCUNA UYGUNDUR. COMPATIBLE WITH MTSBH INSERT.			

-°	AHFMC-JD..	Uç / Insert	Takım Kodu / Tool Code
		JDMW 1204..	AHFMC-JD1204-D052-A22-Z03-H AHFMC-JD1204-D052-A22-Z04-H AHFMC-JD1204-D063-A22-Z05-H AHFMC-JD1204-D080-A27-Z06-H AHFMC-JD1204-D100-A32-Z07-H
		JDMW 1405..	AHFMC-JD1405-D052-A22-Z03-H AHFMC-JD1405-D063-A22-Z04-H
MTSBH UCUNA UYGUNDUR. COMPATIBLE WITH MTSBH INSERT.			

-°	AHFM-SP0735	Uç / Insert	Takım Kodu / Tool Code
		SPMX 073505	AHFM-SP0735-D16-M08-L23-Z02-H AHFM-SP0735-D20-M10-L30-Z03-H AHFM-SP0735-D25-M12-L35-Z04-H
MTSBH UCUNA UYGUNDUR. COMPATIBLE WITH MTSBH INSERT.			

-°	AHFM-SP0945	Uç / Insert	Takım Kodu / Tool Code
		SPMX 0945..	AHFM-SP0945-D050-A22-Z06-H AHFM-SP0945-D052-A22-Z06-H
MTSBH UCUNA UYGUNDUR. COMPATIBLE WITH MTSBH INSERT.			

45°	AFM45-SE13M	Uç / Insert	Takım Kodu / Tool Code
		SEMT 13T3..	AFM45-SE13M-D050-A22-Z04-H AFM45-SE13M-D063-A22-Z05-H AFM45-SE13M-D080-A27-Z06 AFM45-SE13M-D100-A32-Z07 AFM45-SE13M-D125-B40-Z08
MTSBH UCUNA UYGUNDUR. COMPATIBLE WITH MTSBH INSERT.			

45°	AFM45S-SE13M	Uç / Insert	Takım Kodu / Tool Code
		SEMT 13T3..	AFM45S-SE13M-D050-A22-Z04-H AFM45S-SE13M-D063-A22-Z05-H AFM45S-SE13M-D080-A27-Z06 AFM45S-SE13M-D100-A32-Z07 AFM45S-SE13M-D125-B40-Z08
MTSBH UCUNA UYGUNDUR. COMPATIBLE WITH MTSBH INSERT.			

-°	AFMR-RP1204M	Uç / Insert	Takım Kodu / Tool Code
		RPMT 1204..	AFMR-RP1204M-D040-A16-Z04-H AFMR-RP1204M-D042-A16-Z04-H AFMR-RP1204M-D050-A22-Z04-H AFMR-RP1204M-D052-A22-Z05-H AFMR-RP1204M-D063-A22-Z05-H AFMR-RP1204M-D080-A27-Z06-H
MTSBH UCUNA UYGUNDUR. COMPATIBLE WITH MTSBH INSERT.			

-°	AHFMC-JD1204	Uç / Insert	Takım Kodu / Tool Code
		JDMW 1204..	AHFMC-JD1204-D32-M16-L43-Z02-H AHFMC-JD1204-D42-M16-L43-Z03-H
MTSBH UCUNA UYGUNDUR. COMPATIBLE WITH MTSBH INSERT.			

-°	AHFM-SP0735	Uç / Insert	Takım Kodu / Tool Code
		SPMX 073505	AHFM-SP0735-D16-C16-L160-Z02-H AHFM-SP0735-D17-C16-L160-Z02-H AHFM-SP0735-D20-C20-L160-Z03-H AHFM-SP0735-D21-C20-L160-Z03-H
MTSBH UCUNA UYGUNDUR. COMPATIBLE WITH MTSBH INSERT.			

-°	AHFM-SP0945	Uç / Insert	Takım Kodu / Tool Code
		SPMX 094506	AHFM-SP0945-D32-M16-L43-Z04-H AHFM-SP0945-D35-M16-L43-Z04-H AHFM-SP0945-D42-M16-L43-Z05-H
MTSBH UCUNA UYGUNDUR. COMPATIBLE WITH MTSBH INSERT.			



40°	AFM40-NN..	Uç / Insert	Takım Kodu / Tool Code
		NNMU 2007..	AFM40-NN2007-D080-A27-Z06-H AFM40-NN2007-D100-B32-Z07-H AFM40-NN2007-D125-B40-Z08-H AFM40-NN2007-D160-C40-Z10 AFM40-NN2007-D200-C60-Z12
MTSBH UCUNA UYGUNDUR. COMPATIBLE WITH MTSBH INSERT.			



45°	AFM45-NN2007	Uç / Insert	Takım Kodu / Tool Code
		NNMU 2007..	AFM45-NN2007-D063-A22-Z05-H AFM45-NN2007-D080-A27-Z06-H AFM45-NN2007-D100-A32-Z07-H AFM45-NN2007-D125-B40-Z08 AFM45-NN2007-D160-C40-Z10
MTSBH UCUNA UYGUNDUR. COMPATIBLE WITH MTSBH INSERT.			



90°	AFM90-6N14	Uç / Insert	Takım Kodu / Tool Code
		6NMU 1409..	AFM90-6N14-D050-A22-Z04-H AFM90-6N14-D063-A22-Z05-H AFM90-6N14-D080-A27-Z07-H AFM90-6N14-D100-A32-Z07-H AFM90-6N14-D125-B40-Z08
MTSBH UCUNA UYGUNDUR. COMPATIBLE WITH MTSBH INSERT.			



Frezeleme Takımları / Milling Tools



<p>0°</p>  <p>MTSBH UCUNA UYGUNDUR. COMPATIBLE WITH MTSBH INSERT.</p>	<p>AHFM-J009</p> <p>Uç / Insert</p> <p>JOMU 0905..</p>	<p>Takım Kodu / Tool Code</p> <p>AHFM-J009-D050-A22-Z04-H AHFM-J009-D063-A22-Z05-H</p>	<p>45°</p>  <p>NTK UCUNA UYGUNDUR. COMPATIBLE WITH NTK INSERT.</p>	<p>AFM45C-SN..</p> <p>Uç / Insert</p> <p>SN.. 120412</p>	<p>Takım Kodu / Tool Code</p> <p>AFM45C-SN1204-D080-A27-Z07 AFM45C-SN1204-D160-C40-Z14</p>
<p>88°</p>  <p>NTK UCUNA UYGUNDUR. COMPATIBLE WITH NTK INSERT.</p>	<p>AFM88C-SN1204</p> <p>Uç / Insert</p> <p>SN.. 1204..</p>	<p>Takım Kodu / Tool Code</p> <p>AFM88C-SN1204-D050-A22-Z05 AFM88C-SN1204-D063-A22-Z06 AFM88C-SN1204-D080-A27-Z07 AFM88C-SN1204-D100-A32-Z08 AFM88C-SN1204-D125-B40-Z11</p>	<p>75°</p>  <p>NTK UCUNA UYGUNDUR. COMPATIBLE WITH NTK INSERT.</p>	<p>AFM75CS-SN..</p> <p>Uç / Insert</p> <p>SN.. 1204..</p>	<p>Takım Kodu / Tool Code</p> <p>AFM75CS-SN1204-D063-A22-Z06 AFM75CS-SN1204-D080-A27-Z08 AFM75CS-SN1204-D125-B40-Z12 AFM75CS-SN1204-D160-C40-Z14</p>
<p>88°</p>  <p>NTK UCUNA UYGUNDUR. COMPATIBLE WITH NTK INSERT.</p>	<p>AFM88CS-SN..</p> <p>Uç / Insert</p> <p>SN.. 1204..</p>	<p>Takım Kodu / Tool Code</p> <p>AFM88CS-SN1204-D063-A22-Z06 AFM88CS-SN1204-D080-A27-Z08 AFM88CS-SN1204-D100-A32-Z10 AFM88CS-SN1204-D125-B40-Z12</p>	<p>90°</p>  <p>OKE UCUNA UYGUNDUR. COMPATIBLE WITH OKE INSERT.</p>	<p>AFM90-6N09</p> <p>Uç / Insert</p> <p>6NGU 0905..</p>	<p>Takım Kodu / Tool Code</p> <p>AFM90-6N09-D050-A22-Z05-H AFM90-6N09-D063-A22-Z06-H AFM90-6N09-D080-A27-Z07-H AFM90-6N09-D100-A32-Z08-H</p>
<p>90°</p>  <p>PLBT UCUNA UYGUNDUR. COMPATIBLE WITH PLBT INSERT.</p>	<p>AEM90-AP16P</p> <p>Uç / Insert</p> <p>AP.. 1604..</p>	<p>Takım Kodu / Tool Code</p> <p>AEM90-AP16P-D25-W25-L100-Z02-H AEM90-AP16P-D25-W25-L150-Z02 AEM90-AP16P-D32-W32-L150-Z03 AEM90-AP16P-D32-C32-L250-Z02 AEM90-AP16P-D40-W32-L150-Z04</p>	<p>90°</p>  <p>PLBT UCUNA UYGUNDUR. COMPATIBLE WITH PLBT INSERT.</p>	<p>AEM90-XP..</p> <p>Uç / Insert</p> <p>XP.. 0602..</p>	<p>Takım Kodu / Tool Code</p> <p>AEM90-XP0602-D10-C10-L055-Z02-H AEM90-XP0602-D10-C10-L100-Z02-H AEM90-XP0602-D12-C12-L080-Z02-H AEM90-XP0602-D12-C12-L120-Z03-H</p>
<p>90°</p>  <p>PLBT UCUNA UYGUNDUR. COMPATIBLE WITH PLBT INSERT.</p>	<p>AFM90-AP16P</p> <p>Uç / Insert</p> <p>AP.. 1604..</p>	<p>Takım Kodu / Tool Code</p> <p>AFM90-AP16P-D040-A16-Z04-H AFM90-AP16P-D050-A22-Z05-H AFM90-AP16P-D063-A22-Z06-H AFM90-AP16P-D080-A27-Z07-H AFM90-AP16P-D100-A32-Z08-H</p>			



-°	AHFM-XN06T3	Uç / Insert	Takım Kodu / Tool Code
		XN.. 06T3..	AHFM-XN06T3-D20-W20-L110-Z03-H AHFM-XN06T3-D20-W20-L80-Z03-H
PLBT UCUNA UYGUNDUR. COMPATIBLE WITH PLBT INSERT.			



-°	AHFM-XN..	Uç / Insert	Takım Kodu / Tool Code
		XNKU 12..	AHFM-XN12-D32-W32-L150-Z02-H AHFM-XN12-D32-W32-L200-Z02-H AHFM-XN12-D40-W32-L150-Z03-H
PLBT UCUNA UYGUNDUR. COMPATIBLE WITH PLBT INSERT.			

45°	AFM45C-SN1206	Uç / Insert	Takım Kodu / Tool Code
		SN.. 1206..	AFM45C-SN1206-D050-A22-Z04-H AFM45C-SN1206-D050-A22-Z05-H AFM45CL-SN1206-D050-A22-Z05-H AFM45C-SN1206-D063-A22-Z06-H AFM45C-SN1206-D063-A22-Z07-H AFM45CL-SN1206-D063-A22-Z07-H AFM45C-SN1206-D080-A27-Z07-H AFM45C-SN1206-D080-A27-Z08-H AFM45CL-SN1206-D080-A27-Z08-H AFM45C-SN1206-D100-A32-Z08-H AFM45C-SN1206-D100-A32-Z10-H AFM45CL-SN1206-D100-A32-Z10-H AFM45C-SN1206-D125-B40-Z11 AFM45CL-SN1206-D125-B40-Z11 AFM45C-SN1206-D160-C40-Z12 AFM45C-SN1206-D200-C60-Z14 AFM45CL-SN1206-D200-C60-Z14
PLBT UCUNA UYGUNDUR. COMPATIBLE WITH PLBT INSERT.			



44°	AFM44-ON0606	Uç / Insert	Takım Kodu / Tool Code
		ONHX 0606..	AFM44-ON0606-D063-A22-Z05-H AFM44-ON0606-D063-A22-Z06-H AFM44-ON0606-D080-A27-Z08-H AFM44-ON0606-D080-B27-Z06-H AFM44-ON0606-D100-A32-Z10-H AFM44-ON0606-D100-B32-Z07-H AFM44-ON0606-D125-B40-Z08-H
PLBT UCUNA UYGUNDUR. COMPATIBLE WITH PLBT INSERT.			



-°	AHFM-SO..	Uç / Insert	Takım Kodu / Tool Code
		SOEW 0803..	AHFM-SO0803P-D20-W20-L130-Z02-H AHFM-SO0803P-D20-W20-L190-Z02-H AHFM-SO0803P-D25-W25-L140-Z03-H AHFM-SO0803P-D25-W25-L200-Z03-H AHFM-SO0803P-D32-W32-L150-Z04-H AHFM-SO0803P-D32-W32-L200-Z04-H
PLBT UCUNA UYGUNDUR. COMPATIBLE WITH PLBT INSERT.			

-°	AHFM-SO0803P	Uç / Insert	Takım Kodu / Tool Code
		SOEW 0803	AHFM-SO0803P-D32-M16-L35-Z04-H AHFM-SO0803P-D42-M16-L35-Z05-H
PLBT UCUNA UYGUNDUR. COMPATIBLE WITH PLBT INSERT.			

-°	AHFM-SP13	Uç / Insert	Takım Kodu / Tool Code
		SP.. 1305..	AHFM-SP13-D050-A22-Z04-H AHFM-SP13-D063-A27-Z05-H
PLBT UCUNA UYGUNDUR. COMPATIBLE WITH PLBT INSERT.			

-°	AHFM-XN..	Uç / Insert	Takım Kodu / Tool Code
		XNKU 12..	AHFM-XN12-D050-A22-Z04-H AHFM-XN12-D052-A22-Z04-H AHFM-XN12-D063-A22-Z05-H AHFM-XN12-D080-A27-Z06-H AHFM-XN12-D100-A32-Z06-H
PLBT UCUNA UYGUNDUR. COMPATIBLE WITH PLBT INSERT.			

-°	AEM90-AD..	Uç / Insert	Takım Kodu / Tool Code
		AD.. 0602..	AEM90-AD06-D12-M06-L20-Z02-H AEM90-AD06-D16-M08-L23-Z03-H
		AD.. 1003..	AEM90-AD10PR-D16-M08-L23-Z02-H AEM90-AD10PR-D20-M10-L30-Z03-H AEM90-AD10PR-D25-M12-L35-Z04-H AEM90-AD10PR-D32-M16-L40-Z04-H AEM90-AD10PR-D35-M16-L45-Z05-H
		AD.. 1304..	AEM90-AD13-D20-M10-L30-Z02-H AEM90-AD13-D25-M12-L35-Z03-H AEM90-AD13-D32-M16-L40-Z03-H AEM90-AD13-D35-M16-L45-Z04-H
PRMT UCUNA UYGUNDUR. COMPATIBLE WITH PRMT INSERT.			

-°	AEM90-AD..	Uç / Insert	Takım Kodu / Tool Code
		AD.. 0602..	AEM90-AD06-D10-C10-L100-Z02-H AEM90-AD06-D12-C12-L120-Z02-H AEM90-AD06-D16-C16-L160-Z03-H
		AD.. 1003..	AEM90-AD10PR-D16-C15-L170-Z02-H AEM90-AD10PR-D16-C16-L170-Z02-H AEM90-AD10PR-D20-C19-L170-Z03-H AEM90-AD10PR-D20-C20-L170-Z03-H AEM90-AD10PR-D25-C25-L200-Z03-H
		AD.. 1304..	AEM90-AD13-D20-C20-L150-Z02-H AEM90-AD13-D25-C25-L170-Z02-H
PRMT UCUNA UYGUNDUR. COMPATIBLE WITH PRMT INSERT.			

Frezeleme Takımları / Milling Tools

-°	AEM90-AD..	Uç / Insert	Takım Kodu / Tool Code
	AD.. 1304..		AFM90-AD13-D040-A16-Z04-H
			AFM90-AD13-D050-A22-Z05-H
			AFM90-AD13-D063-A22-Z06-H
			AFM90-AD13-D080-A27-Z07-H
	AD.. 1606..		new AFM90-AD16PR-D050-A22-Z05-H
			new AFM90-AD16PR-D063-A22-Z05-H
			AFM90-AD16PR-D080-A27-Z07-H
			new AFM90-AD16PR-D100-A32-Z07-H
	AD.. 1706..		AFM90-AD17-D040-A16-Z04-H
			AFM90-AD17-D050-A22-Z05-H
			AFM90-AD17-D063-A22-Z05-H
			AFM90-AD17-D080-A27-Z06-H
			AFM90-AD17-D100-A32-Z07-H

PRMT UCUNA UYGUNDUR.
COMPATIBLE WITH PRMT INSERT.

90°	AEM90-RT..	Uç / Insert	Takım Kodu / Tool Code	
	RT 0702..		AEM90-RT07-D10-W10-L120-Z02	
			AEM90-RT07-D12-C12-L120-Z02	
			AEM90-RT07-D12-W12-L120-Z02	
			AEM90-RT07-D14-W12-L120-Z02	
	RT 1003..		AEM90-RT10-D16-C15-L160-Z02	
			AEM90-RT10-D16-W16-L120-Z02-H	
			AEM90-RT10-D16-W16-L150-Z02	
			AEM90-RT10-D16-C16-L200-Z02	
			AEM90-RT10-D17-W16-L160-Z02	
			AEM90-RT10-D17-C16-L200-Z02	
			AEM90-RT10-D18-W16-L120-Z02-H	
			AEM90-RT10-D20-C19-L200-Z03	
AEM90-RT10-D20-C20-L110-Z03				
AEM90-RT10-D20-W20-L120-Z03-H				
AEM90-RT10-D20-W20-L150-Z03				
AEM90-RT10-D20-C20-L200-Z03				
AEM90-RT10-D21-W20-L200-Z03				
AEM90-RT10-D22-W20-L120-Z03-H				
AEM90-RT10-D22-C20-L150-Z03				
AEM90-RT10-D22-C20-L200-Z03				
AEM90-RT10-D25-W25-L120-Z04-H				
AEM90-RT10-D25-W25-L150-Z04				
AEM90-RT10-D25-C25-L200-Z04				
AEM90-RT10-D26-C25-L250-Z04				
AEM90-RT10-D32-W32-L120-Z05-H				
AEM90-RT10-D32-W32-L150-Z05				
AEM90-RT10-D32-C32-L200-Z05				
AEM90-RT10-D33-C32-L250-Z04				
RT 1304..				AEM90-RT13-D32-C32-L250-Z04
RT 1604..				AEM90-RT16-D25-W25-L120-Z02-H
				AEM90-RT16-D25-W25-L150-Z02
				AEM90-RT16-D25-C25-L200-Z02
	AEM90-RT16-D32-W32-L120-Z03-H			
	AEM90-RT16-D32-W32-L150-Z03			
	AEM90-RT16-D32-C32-L200-Z03			
	AEM90-RT16-D32-C32-L250-Z03			
	AEM90-RT16-D32-C32-L270-Z03			
	AEM90-RT16-D40-W32-L120-Z04-H			
	AEM90-RT16-D40-W32-L150-Z04			
AEM90-RT16-D40-C32-L200-Z04				

PRMT UCUNA UYGUNDUR.
COMPATIBLE WITH PRMT INSERT.

90°	AEM90-AD..	Uç / Insert	Takım Kodu / Tool Code		
	ADMX 0702..		AEM90-AD07-D10-C08-L90-Z02-H		
			AEM90-AD07-D10-C10-L80-Z02-H		
			AEM90-AD07-D12-C10-L80-Z03-H		
			AEM90-AD07-D12-C12-L90-Z03-H		
			AEM90-AD07-D16-C16-L110-Z04-H		
			AEM90-AD07-D20-C20-L125-Z05-H		
			AEM90-AD07-D25-C25-L140-Z06-H		
			ADMX 11T3..		AEM90-AD11-D16-C16-L135-Z02-H
					AEM90-AD11-D18-C16-L135-Z02-H
					AEM90-AD11-D18-C16-L160-Z02-H
					AEM90-AD11-D20-C20-L150-Z02-H
					AEM90-AD11-D20-C20-L150-Z03-H
	AEM90-AD11-D22-C20-L150-Z03-H				
	AEM90-AD11-D22-C20-L200-Z03-H				
	AEM90-AD11-D25-C25-L170-Z03-H				
	AEM90-AD11-D25-C25-L170-Z04-H				
	AEM90-AD11-D28-C25-L165-Z04-H				
	AEM90-AD11-D28-C25-L200-Z04-H				
	AEM90-AD11-D30-C25-L165-Z04-H				
	AEM90-AD11-D30-C25-L200-Z04-H				
	AEM90-AD11-D32-C32-L195-Z05-H				

PRMT UCUNA UYGUNDUR.
COMPATIBLE WITH PRMT INSERT.

45°	AFM45-HN..	Uç / Insert	Takım Kodu / Tool Code
	HN.. 0906..		AFM45-HN0906-D050-A22-Z04-H
			AFM45-HN0906-D063-A22-Z06-H
			AFM45-HN0906-D080-A27-Z08-H
			AFM45-HN0906-D100-A32-Z10
			AFM45-HN0906-D125-B40-Z12
			AFM45-HN0906-D160-C40-Z14
			AFM45-HN0906-D200-C60-Z10



PRMT UCUNA UYGUNDUR.
COMPATIBLE WITH PRMT INSERT.

90°	AEM90-RT10	Uç / Insert	Takım Kodu / Tool Code
	RT 0702..		AEM90-RT07-D13-M06-L20-Z02-H
			AEM90-RT10-D16-M08-L20-Z02-H
	RT 1003..		AEM90-RT10-D17-M08-L20-Z02-H
			AEM90-RT10-D20-M10-L25-Z03-H
			AEM90-RT10-D21-M10-L25-Z03-H
			AEM90-RT10-D26-M12-L35-Z03-H
			AEM90-RT10-D26-M12-L35-Z04-H
			AEM90-RT10-D25-M12-L30-Z04-H
			AEM90-RT10-D32-M16-L43-Z05-H
			AEM90-RT10-D42-M16-L43-Z06-H



PRMT UCUNA UYGUNDUR.
COMPATIBLE WITH PRMT INSERT.



90°	AFM90-RT..	Uç / Insert	Takım Kodu / Tool Code
	RT 1003..		AFM90-RT10-D040-A16-Z06-H
			AFM90-RT10-D050-A22-Z07-H
			AFM90-RT10-D063-A22-Z09-H
	RT 1606..		AFM90-RT16-D040-A16-Z04-H
			AFM90-RT16-D063-A22-Z06-H
			AFM90-RT16-D080-A27-Z07-H
			AFM90-RT16-D125-B40-Z09



PRMT UCUNA UYGUNDUR.
COMPATIBLE WITH PRMT INSERT.



90°	AEM90-TNG10	Uç / Insert	Takım Kodu / Tool Code
		TNGX 1004..	AEM90-TNG10-D20-M10-L26-Z02-H AEM90-TNG10-D20-M10-L26-Z03-H AEM90-TNG10-D21-M10-L25-Z03-H AEM90-TNG10-D25-M12-L33-Z03-H AEM90-TNG10-D25-M12-L33-Z04-H AEM90-TNG10-D26-M12-L30-Z04-H AEM90-TNG10-D32-M16-L43-Z04-H AEM90-TNG10-D32-M16-L43-Z05-H AEM90-TNG10-D33-M16-L43-Z05-H AEM90-TNG10-D35-M16-L43-Z05-H
PRMT UCUNA UYGUNDUR. COMPATIBLE WITH PRMT INSERT.			



90°	AFM90-TNG10	Uç / Insert	Takım Kodu / Tool Code
		TNGX 1004..	AFM90-TNG10-D040-A16-Z04-H AFM90-TNG10-D040-A16-Z06-H AFM90-TNG10-D050-A22-Z05-H AFM90-TNG10-D050-A22-Z07-H AFM90-TNG10-D063-A22-Z06-H AFM90-TNG10-D063-A22-Z09-H AFM90-TNG10-D080-A27-Z10-H
		TNGX 1606..	AFM90-TNG16-D040-A16-Z03-H AFM90-TNG16-D040-A16-Z04-H AFM90-TNG16-D050-A22-Z04-H AFM90-TNG16-D050-A22-Z05-H AFM90-TNG16-D063-A22-Z04-H AFM90-TNG16-D063-A22-Z06-H AFM90-TNG16-D080-A27-Z05-H AFM90-TNG16-D080-A27-Z07-H AFM90-TNG16-D100-A32-Z06-H AFM90-TNG16-D100-A32-Z08-H AFM90-TNG16-D115-A32-Z06-H AFM90-TNG16-D125-A40-Z07-H AFM90-TNG16-D125-A40-Z09-H AFM90-TNG16-D140-B40-Z08-H AFM90-TNG16-D160-C40-Z10-H AFM90-TNG16-D175-C40-Z10-H
PRMT UCUNA UYGUNDUR. COMPATIBLE WITH PRMT INSERT.			

-°	AHFM-BN10T3	Uç / Insert	Takım Kodu / Tool Code
		BNGX 10T3..	AHFM-BN10T3-D16-M08-L25-Z02-H AHFM-BN10T3-D20-M10-L30-Z04-H AHFM-BN10T3-D25-M12-L33-Z05-H AHFM-BN10T3-D32-M16-L40-Z06-H AHFM-BN10T3-D40-M16-L43-Z06-H
PRMT UCUNA UYGUNDUR. COMPATIBLE WITH PRMT INSERT.			



-°	AHFM-BN10T3	Uç / Insert	Takım Kodu / Tool Code
		BNGX 10T3..	AHFM-BN10T3-D040-A16-Z05-H AHFM-BN10T3-D042-A16-Z05-H AHFM-BN10T3-D050-A22-Z07-H AHFM-BN10T3-D052-A22-Z07-H
PRMT UCUNA UYGUNDUR. COMPATIBLE WITH PRMT INSERT.			



90°	AEM90-TNG10	Uç / Insert	Takım Kodu / Tool Code
		TNGX 1004..	AEM90-TNG10-D20-W20-L90-Z02-H AEM90-TNG10-D20-W20-L90-Z03-H AEM90-TNG10-D20-C20-L125-Z02-H AEM90-TNG10-D20-C20-L125-Z03-H AEM90-TNG10-D20-C20-L150-Z03-H AEM90-TNG10-D21-C20-L200-Z03-H AEM90-TNG10-D25-C25-L150-Z03-H AEM90-TNG10-D25-W25-L100-Z03-H AEM90-TNG10-D25-W25-L100-Z04-H AEM90-TNG10-D25-C25-L150-Z04-H AEM90-TNG10-D25-C25-L170-Z04-H AEM90-TNG10-D26-C25-L250-Z04-H AEM90-TNG10-D28-W25-L100-Z04-H AEM90-TNG10-D32-W32-L110-Z04-H AEM90-TNG10-D32-W32-L110-Z05-H AEM90-TNG10-D32-C32-L170-Z04-H AEM90-TNG10-D32-C32-L170-Z05-H AEM90-TNG10-D33-C32-L250-Z05-H
		TNGX 1606..	AEM90-TNG16-D25-C25-L170-Z02-H AEM90-TNG16-D25-C25-L170-Z02-H-80 AEM90-TNG16-D25-W25-L110-Z02-H AEM90-TNG16-D32-C25-L195-Z02-H AEM90-TNG16-D32-C25-L195-Z03-H AEM90-TNG16-D32-C32-L195-Z02-H AEM90-TNG16-D32-C32-L195-Z02-H-80 AEM90-TNG16-D32-C32-L195-Z03-H AEM90-TNG16-D32-W32-L110-Z03-H AEM90-TNG16-D35-C32-L195-Z04-H AEM90-TNG16-D40-W32-L120-Z04-H
PRMT UCUNA UYGUNDUR. COMPATIBLE WITH PRMT INSERT.			

-°	AHFM-BN10T3	Uç / Insert	Takım Kodu / Tool Code
		BNGX 10T3..	AHFM-BN10T3-D16-C16-L100-Z02-H AHFM-BN10T3-D16-C16-L150-Z02-H AHFM-BN10T3-D20-C20-L130-Z03-H AHFM-BN10T3-D20-C20-L130-Z04-H AHFM-BN10T3-D20-C20-L160-Z03-H AHFM-BN10T3-D25-C25-L140-Z04-H AHFM-BN10T3-D25-W25-L140-Z04-H AHFM-BN10T3-D25-C25-L140-Z05-H AHFM-BN10T3-D25-C25-L180-Z04-H AHFM-BN10T3-D32-C32-L150-Z05-H AHFM-BN10T3-D32-C32-L150-Z06-H AHFM-BN10T3-D35-C32-L200-Z06-H
PRMT UCUNA UYGUNDUR. COMPATIBLE WITH PRMT INSERT.			



90°	AEM90-XC13	Uç / Insert	Takım Kodu / Tool Code
		XCKX 13T3..	AEM90-XC13-D20-W20-L150-Z02 AEM90-XC13-D25-W25-L150-Z03 AEM90-XC13-D32-W32-L150-Z04
SC UCUNA UYGUNDUR. COMPATIBLE WITH SC INSERT.			



Frezeleme Takımları / Milling Tools

-°	AHFM-SN1104	Uç / Insert	Takım Kodu / Tool Code
		SN.. 1104..	AHFM-SN1104-D042-A16-Z04-H AHFM-SN1104-D050-A22-Z05-H AHFM-SN1104-D050-A22-Z06-H AHFM-SN1104-D052-A22-Z05-H AHFM-SN1104-D052-A22-Z06-H AHFM-SN1104-D063-A22-Z06-H AHFM-SN1104-D066-A27-Z06-H AHFM-SN1104-D080-A27-Z07-H AHFM-SN1104-D080-A27-Z09-H AHFM-SN1104-D100-A32-Z08-H AHFM-SN1104-D125-B40-Z08-H
PRMT UCUNA UYGUNDUR. COMPATIBLE WITH PRMT INSERT.			



90°	AFM90-X012	Uç / Insert	Takım Kodu / Tool Code
		X0.. 1204..	AFM90-X012-D040-A16-Z05-H AFM90-X012-D050-A22-Z07-H AFM90-X012-D063-A22-Z08-H AFM90-X012-D080-A27-Z10-H AFM90-X012-D100-A32-Z12-H
SC UCUNA UYGUNDUR. COMPATIBLE WITH SC INSERT.			

90°	AEM90-XN..	Uç / Insert	Takım Kodu / Tool Code
		XNEX 0403..	AEM90-XN0403-D16-C16-L100-Z01-H new AEM90-XN0403-D20-W20-L100-Z03-H AEM90-XN0403-D22-C20-L110-Z03-H new AEM90-XN0403-D25-W25-L150-Z04-H
SC UCUNA UYGUNDUR. COMPATIBLE WITH SC INSERT.		XNEX 0806..	AEM90-XN0806-D32-C32-L110-Z02-H

90°	AEM90-XN043	Uç / Insert	Takım Kodu / Tool Code
		XNEX 0403..	new AEM90-XN0403-D21-M10-L32-Z03-H new AEM90-XN0403-D26-M12-L38-Z04-H AEM90-XN0403-D32-M16-L43-Z05-H AEM90-XN0403-D42-M16-L43-Z06-H
SC UCUNA UYGUNDUR. COMPATIBLE WITH SC INSERT.			



88°	AFM88-SN12SC	Uç / Insert	Takım Kodu / Tool Code
		SN.. 1204..	AFM88-SN12SC-D050-A22-Z05-H AFM88-SN12SC-D063-A22-Z06-H AFM88-SN12SC-D080-A27-Z07-H AFM88-SN12SC-D100-A32-Z08-H
SC UCUNA UYGUNDUR. COMPATIBLE WITH SC INSERT.			



90°	AFM90-RT..	Uç / Insert	Takım Kodu / Tool Code
		RT 1003..	AFM90-RT10-D040-A16-Z06-H AFM90-RT10-D050-A22-Z07-H AFM90-RT10-D063-A22-Z09-H
SFTY UCUNA UYGUNDUR. COMPATIBLE WITH SFTY INSERT.		RT 1606..	AFM90-RT16-D040-A16-Z04-H AFM90-RT16-D063-A22-Z06-H AFM90-RT16-D080-A27-Z07-H AFM90-RT16-D125-B40-Z09

90°	AEM90-XO..	Uç / Insert	Takım Kodu / Tool Code
		XO.. 0602..	AEM90-XO06-D10-C10-L100-Z02-H AEM90-XO06-D10-C12-L120-Z02
		XO.. 0903..	AEM90-XO09-D12-C12-L120-Z02 AEM90-XO09-D12-C12-L120-Z02-H
		XO.. 1204..	AEM90-X012-D16-W16-L150-Z02 AEM90-X012-D20-W20-L150-Z03 AEM90-X012-D16-C16-L170-Z02-H AEM90-X012-D20-C20-L170-Z03-H AEM90-X012-D20-C19-L170-Z03-H AEM90-X012-D20-C20-L170-Z03-H AEM90-X012-D20-W20-L150-Z02 AEM90-X012-D20-C20-L200-Z02 AEM90-X012-D22-W20-L150-Z02 AEM90-X012-D25-W25-L150-Z03 AEM90-X012-D25-C25-L170-Z03-H AEM90-X012-D25-C25-L200-Z03 AEM90-X012-D32-C25-L150-Z04 AEM90-X012-D32-W32-L150-Z04 AEM90-X012-D32-C32-L250-Z04
SC UCUNA UYGUNDUR. COMPATIBLE WITH SC INSERT.			

75°	AFM75-X012	Uç / Insert	Takım Kodu / Tool Code
		X0.. 1204..	AFM75-X012-D050-A22-Z04-H AFM75-X012-D063-A22-Z05-H AFM75-X012-D080-A27-Z06-H
SC UCUNA UYGUNDUR. COMPATIBLE WITH SC INSERT.			

90°	AFM90-XN..	Uç / Insert	Takım Kodu / Tool Code
		XNEX 0403..	AFM90-XN0403-D040-A16-Z05-H AFM90-XN0806-D050-A22-Z04-H AFM90-XN0806-D050-A22-Z05-H AFM90-XN0806-D063-A22-Z05-H AFM90-XN0806-D080-A27-Z07-H AFM90-XN0806-D100-A32-Z08-H
SC UCUNA UYGUNDUR. COMPATIBLE WITH SC INSERT.		XNEX 0806..	new AEM90-XN0806-D125-B40-Z10

90°	AFM90-L008	Uç / Insert	Takım Kodu / Tool Code
		LOEX 0804..	AFM90-L008-D040-A16-Z06-H AFM90-L008-D050-A22-Z07-H AFM90-L008-D063-A27-Z06-H
SC UCUNA UYGUNDUR. COMPATIBLE WITH SC INSERT.			

90°	AEM90-AP10S	Uç / Insert	Takım Kodu / Tool Code
		AP.. 1003..	AEM90-AP10S-D16-W16-L150-Z02 AEM90-AP10S-D20-W20-L150-Z02 AEM90-AP10S-D25-W25-L150-Z03
SMTM UCUNA UYGUNDUR. COMPATIBLE WITH SMTM INSERT.			

90°	AEM90-RT..	Uç / Insert	Takım Kodu / Tool Code
		RT 0702..	AEM90-RT07-D10-W10-L120-Z02 AEM90-RT07-D12-C12-L120-Z02 AEM90-RT07-D12-W12-L120-Z02 AEM90-RT07-D14-W12-L120-Z02
		RT 1003..	AEM90-RT10-D16-C15-L160-Z02 AEM90-RT10-D16-W16-L120-Z02-H AEM90-RT10-D16-W16-L150-Z02 AEM90-RT10-D16-C16-L200-Z02 AEM90-RT10-D17-W16-L160-Z02 AEM90-RT10-D17-C16-L200-Z02 AEM90-RT10-D18-W16-L120-Z02-H AEM90-RT10-D20-C19-L200-Z03 AEM90-RT10-D20-C20-L110-Z03 AEM90-RT10-D20-W20-L120-Z03-H AEM90-RT10-D20-W20-L150-Z03 AEM90-RT10-D20-C20-L200-Z03 AEM90-RT10-D21-W20-L200-Z03 AEM90-RT10-D22-W20-L120-Z03-H AEM90-RT10-D22-C20-L150-Z03 AEM90-RT10-D22-C20-L200-Z03 AEM90-RT10-D25-W25-L120-Z04-H AEM90-RT10-D25-W25-L150-Z04 AEM90-RT10-D25-C25-L200-Z04 AEM90-RT10-D26-C25-L250-Z04 AEM90-RT10-D32-W32-L120-Z05-H AEM90-RT10-D32-W32-L150-Z05 AEM90-RT10-D32-C32-L200-Z05 AEM90-RT10-D33-C32-L250-Z04
		RT 1304..	AEM90-RT13-D32-C32-L250-Z04
		RT 1604..	AEM90-RT16-D25-W25-L120-Z02-H AEM90-RT16-D25-W25-L150-Z02 AEM90-RT16-D25-C25-L200-Z02 AEM90-RT16-D32-W32-L120-Z03-H AEM90-RT16-D32-W32-L150-Z03 AEM90-RT16-D32-C32-L200-Z03 AEM90-RT16-D32-C32-L250-Z03 AEM90-RT16-D32-C32-L270-Z03 AEM90-RT16-D40-W32-L120-Z04-H AEM90-RT16-D40-W32-L150-Z04 AEM90-RT16-D40-C32-L200-Z04

SFTY UCUNA UYGUNDUR.
COMPATIBLE WITH SFTY INSERT.

90°	AEM90-S0803	Uç / Insert	Takım Kodu / Tool Code
		SOMT 0803..	AEM90-S00803-D20-C16-L110-Z02-H AEM90-S00803-D25-C20-L110-Z02-H AEM90-S00803-D32-C25-L120-Z03-H

SMTM UCUNA UYGUNDUR.
COMPATIBLE WITH SMTM INSERT.

-°	AEMR-QP10T3	Uç / Insert	Takım Kodu / Tool Code
		QP.. 10T3..	AEMR-QP10T3-D25-M12-L35-Z02-H AEMR-QP10T3-D32-M16-L43-Z03-H

SMTM UCUNA UYGUNDUR.
COMPATIBLE WITH SMTM INSERT.

90°	AEM90-AX..	Uç / Insert	Takım Kodu / Tool Code
		AX.T 1235..	AEM90-AX1235-D16-C14-L120-Z02-H AEM90-AX1235-D16-C15-L145-Z02-H AEM90-AX1235-D16-C16-L100-Z02-H AEM90-AX1235-D16-C16-L140-Z02-H AEM90-AX1235-D16-C16-L145-Z02-H AEM90-AX1235-D16-C16-L150-Z02 AEM90-AX1235-D20-C19-L150-Z02-H AEM90-AX1235-D20-C20-L110-Z03-H AEM90-AX1235-D20-C20-L150-Z02 AEM90-AX1235-D20-C20-L150-Z02-H AEM90-AX1235-D20-C20-L150-Z03 AEM90-AX1235-D25-C20-L120-Z04-H AEM90-AX1235-D25-C20-L150-Z04-H AEM90-AX1235-D25-C24-L170-Z02-H AEM90-AX1235-D25-C25-L120-Z04-H AEM90-AX1235-D25-C25-L150-Z03 AEM90-AX1235-D25-C25-L170-Z02-H AEM90-AX1235-D25-W25-L100-Z04-H AEM90-AX1235-D32-C32-L130-Z05-H AEM90-AX1235-D32-C32-L180-Z02-H
		AX.T 1705..	AEM90-AX1705-D25-C25-L150-Z02 AEM90-AX1705-D28-W25-L115-Z02-H AEM90-AX1705-D32-C32-L150-Z03 AEM90-AX1705-D32-C32-L180-Z02-H

SMTM UCUNA UYGUNDUR.
COMPATIBLE WITH SMTM INSERT.

90°	AEM90-AX..	Uç / Insert	Takım Kodu / Tool Code
		AX.T 1235..	AEM90-AX1235-D16-M08-L30-Z02-H AEM90-AX1235-D20-M10-L30-Z03-H AEM90-AX1235-D25-M12-L35-Z04-H
		AX.T 1705..	AEM90-AX1705-D25-M12-L43-Z02-H AEM90-AX1705-D32-M16-L43-Z02-H

SMTM UCUNA UYGUNDUR.
COMPATIBLE WITH SMTM INSERT.

90°	AFM90-AX1705	Uç / Insert	Takım Kodu / Tool Code
		AX.T 1235..	AFM90-AX1235-D040-A16-Z06-H AFM90-AX1235-D050-A22-Z07-H AFM90-AX1235-D063-A22-Z08-H AFM90-AX1235-D080-A27-Z10-H
		AX.T 1705..	AFM90-AX1705-D040-A16-Z04-H AFM90-AX1705-D050-A22-Z05-H AFM90-AX1705-D063-A22-Z06-H AFM90-AX1705-D080-A27-Z07-H AFM90-AX1705-D100-A32-Z08-H

SMTM UCUNA UYGUNDUR.
COMPATIBLE WITH SMTM INSERT.

-°	AEMR-QP..	Uç / Insert	Takım Kodu / Tool Code
		QP.. 10T3..	AEMR-QP10T3-D20-C20-L150-Z01-H AEMR-QP10T3-D25-C25-L120-Z02-H AEMR-QP10T3-D25-C25-L150-Z02-H AEMR-QP10T3-D25-C25-L170-Z02 AEMR-QP10T3-D32-C32-L150-Z03-H AEMR-QP10T3-D32-C32-L170-Z03
		QP.. 1204..	AEMR-QP1204-D25-C25-L150-Z02-H

SMTM UCUNA UYGUNDUR.
COMPATIBLE WITH SMTM INSERT.

-°	AFMR-QP..	Uç / Insert	Takım Kodu / Tool Code
		QP.. 10T3..	AFMR-QP10T3-D040-A16-Z04-H AFMR-QP10T3-D050-A22-Z05-H AFMR-QP10T3-D063-A22-Z06-H
		QP.. 1204..	AFMR-QP1204-D050-A22-Z04-H AFMR-QP1204-D063-A22-Z05-H

SMTM UCUNA UYGUNDUR.
COMPATIBLE WITH SMTM INSERT.

Frezeleme Takımları / Milling Tools

<p>-°</p> <p>AHFM-LN..</p> <p>Uç / Insert</p> <p>Takım Kodu / Tool Code</p>  <p>SMTM UCUNA UYGUNDUR. COMPATIBLE WITH SMTM INSERT.</p>	<p>LN.. 06T3..</p> <p>AHFM-LN06T3-D16-M08-L25-Z02-H AHFM-LN06T3-D20-M10-L30-Z03-H AHFM-LN06T3-D25-M12-L35-Z04-H AHFM-LN06T3-D32-M16-L40-Z05-H AHFM-LN06T3-D40-M16-L40-Z06-H</p>	<p>90°</p> <p>AEM90-AX..</p> <p>Uç / Insert</p> <p>Takım Kodu / Tool Code</p>  <p>SMTM UCUNA UYGUNDUR. COMPATIBLE WITH SMTM INSERT.</p>	<p>AX.T 1235..</p> <p>AEM90-AX1235-D25-C20-L120-Z04-H AEM90-AX1235-D25-C20-L150-Z04-H AEM90-AX1235-D25-C24-L170-Z02-H AEM90-AX1235-D25-C25-L120-Z04-H AEM90-AX1235-D25-C25-L150-Z03 AEM90-AX1235-D25-C25-L170-Z02-H AEM90-AX1235-D25-W25-L100-Z04-H AEM90-AX1235-D32-C32-L130-Z05-H AEM90-AX1235-D32-C32-L180-Z02-H</p> <p>AX.T 1705..</p> <p>AEM90-AX1705-D25-C25-L150-Z02 AEM90-AX1705-D28-W25-L115-Z02-H AEM90-AX1705-D32-C32-L150-Z03 AEM90-AX1705-D32-C32-L180-Z02-H</p>
<p>-°</p> <p>AHFMC-WD..</p> <p>Uç / Insert</p> <p>Takım Kodu / Tool Code</p>  <p>SMTM UCUNA UYGUNDUR. COMPATIBLE WITH SMTM INSERT.</p>	<p>WDMT 0603..</p> <p>AHFMC-WD0603-D16-C16-L150-Z02 AHFM-WD0603-D20-C20-L150-Z03</p> <p>WDMT 0804..</p> <p>AHFMC-WD0804-D25-C25-L150-Z02 AHFMC-WD0804-D32-C32-L150-Z03</p> <p>WDMT 1205</p> <p>AHFMC-WD1205-D32-C32-L150-Z02</p>	<p>-°</p> <p>AHFMC-WD0804</p> <p>Uç / Insert</p> <p>Takım Kodu / Tool Code</p>  <p>SMTM UCUNA UYGUNDUR. COMPATIBLE WITH SMTM INSERT.</p>	<p>WDMT 0804..</p> <p>AHFMC-WD0804-D25-M12-L35-Z02-H AHFMC-WD0804-D32-M16-L35-Z03-H</p>
<p>-°</p> <p>AHFMC-WD..</p> <p>Uç / Insert</p> <p>Takım Kodu / Tool Code</p>  <p>SMTM UCUNA UYGUNDUR. COMPATIBLE WITH SMTM INSERT.</p>	<p>WDMT 0804..</p> <p>AHFMC-WD0804-D040-A16-Z04-H AHFMC-WD0804-D050-A22-Z04-H</p> <p>WDMT 1205..</p> <p>AHFMC-WD1205-D050-A22-Z04-H AHFMC-WD1205-D052-A22-Z04-H AHFMC-WD1205-D063-A22-Z05-H AHFMC-WD1205-D080-A27-Z06-H</p>	<p>45°</p> <p>AFM45-SE13</p> <p>Uç / Insert</p> <p>Takım Kodu / Tool Code</p>  <p>SMTM UCUNA UYGUNDUR. COMPATIBLE WITH SMTM INSERT.</p>	<p>SEMT 13T3..</p> <p>AFM45-SE13-D050-A22-Z04-H AFM45-SE13-D063-A22-Z05-H AFM45-SE13-D080-A27-Z06-H AFM45S-SE13-D050-A22-Z05-H AFM45S-SE13-D063-A22-Z06-H AFM45S-SE13-D080-A27-Z08-H AFM45S-SE13-D100-A32-Z10-H AFM45S-SE13-D125-B40-Z12</p>
<p>90°</p> <p>AEM90-R390</p> <p>Uç / Insert</p> <p>Takım Kodu / Tool Code</p>  <p>SNDVK UCUNA UYGUNDUR. COMPATIBLE WITH SNDVK INSERT.</p>	<p>R390-11T3..</p> <p>AEM90-R390.11-D12-W12-L100-Z01 AEM90-R390.11-D16-W16-L100-Z02-H AEM90-R390.11-D16-W16-L150-Z02 AEM90-R390.11-D16-W16-L150-Z02-H AEM90-R390.11-D20-W20-L090-Z02-H AEM90-R390.11-D20-W20-L100-Z03-H AEM90-R390.11-D20-W20-L150-Z03 AEM90-R390.11-D20-W20-L150-Z03-H AEM90-R390.11-D20-C20-L150-Z03 AEM90-R390.11-D22-W20-L090-Z02-H AEM90-R390.11-D25-C20-L150-Z03 AEM90-R390.11-D25-W25-L100-Z03-H</p>	<p>Uç / Insert</p> <p>Takım Kodu / Tool Code</p> <p>R390-11T3..</p> <p>AEM90-R390.11-D25-W25-L150-Z03 AEM90-R390.11-D25-W25-L150-Z03-H AEM90-R390.11-D30-W25-L150-Z04-H AEM90-R390.11-D32-C25-L200-Z03 AEM90-R390.11-D32-W32-L150-Z05-H</p> <p>R390-1704..</p> <p>AEM90-R390.17-D25-W25-L150-Z02 AEM90-R390.17-D25-W25-L150-Z02-H AEM90-R390.17-D30-W25-L150-Z03 AEM90-R390.17-D30-W25-L150-Z03-H AEM90-R390.17-D32-W32-L150-Z03-H</p> <p>R390-1806..</p> <p>AEM90-R390.18-D32-C32-L150-Z03 AEM90-R390.18-D40-C32-L150-Z04-H</p>	



90°	AEM90-R390.11	Uç / Insert	Takım Kodu / Tool Code
		R390-11T3	AEM90-R390.11-D16-M08-L30-Z02-H AEM90-R390.11-D20-M10-L30-Z03-H AEM90-R390.11-D25-M12-L35-Z03-H AEM90-R390.11-D32-M16-L43-Z04-H
SNDVK UCUNA UYGUNDUR. COMPATIBLE WITH SNDVK INSERT.			

45°	AFM45-SE..	Uç / Insert	Takım Kodu / Tool Code
		SE.. 12T3.. R245-12T3..	AFM45-SE12-D050-A22-Z04-H AFM45L-SE12-D050-A22-Z04-H AFM45-SE12-D063-A22-Z05-H AFM45L-SE12-D063-A22-Z05-H AFM45-SE12-D080-A27-Z06-H AFM45L-SE12-D080-A27-Z06-H AFM45-SE12-D100-A32-Z07-H AFM45L-SE12-D100-A32-Z07-H AFM45-SE12-D125-B40-Z08 AFM45L-SE12-D125-B40-Z08 AFM45-SE12-D160-C40-Z10 AFM45L-SE12-D160-C40-Z10 AFM45-SE12-D200-C60-Z12 AFM45L-SE12-D200-C60-Z12
SNDVK UCUNA UYGUNDUR. COMPATIBLE WITH SNDVK INSERT.			

90°	AFM90-490R14	Uç / Insert	Takım Kodu / Tool Code
		490R-08T3.. 490R-1404..	AFM90-490R08-D063-A22-Z06-H AFM90-490R14-D050-A22-Z04-H AFM90-490R14-D063-A22-Z05-H AFM90-490R14-D080-A27-Z07-H AFM90-490R14-D100-A32-Z07-H AFM90-490R14-D125-B40-Z08 AFM90-490R14-D125-B40-Z12 AFM90-490R14-D160-C40-Z10 AFM90-490R14-D200-C60-Z16
SNDVK UCUNA UYGUNDUR. COMPATIBLE WITH SNDVK INSERT.			

-°	AFMR-RC1204	Uç / Insert	Takım Kodu / Tool Code
		RC.. 1204..	AFMR-RC1204-D040-A16-Z04-H AFMR-RC1204-D050-A22-Z05-H AFMR-RC1204-D052-A22-Z05-H AFMR-RC1204-D063-A22-Z06-H AFMR-RC1204-D063-A27-Z06-H AFMR-RC1204-D080-A27-Z07-H
SNDVK UCUNA UYGUNDUR. COMPATIBLE WITH SNDVK INSERT.			

90°	AFM90-6N09	Uç / Insert	Takım Kodu / Tool Code
		6NGU 0905..	AFM90-6N09-D050-A22-Z05-H AFM90-6N09-D063-A22-Z06-H AFM90-6N09-D080-A27-Z07-H AFM90-6N09-D100-A32-Z08-H
TGTC UCUNA UYGUNDUR. COMPATIBLE WITH TGTC INSERT.			

90°	AFM90-AN1607	Uç / Insert	Takım Kodu / Tool Code
		AN.X 1607..	AFM90-AN1607-D050-A22-Z04-H AFM90-AN1607-D063-A22-Z06-H AFM90-AN1607-D080-A27-Z07-H AFM90-AN1607-D100-A32-Z08-H AFM90-AN1607-D125-B40-Z10
TGTC UCUNA UYGUNDUR. COMPATIBLE WITH TGTC INSERT.			

90°	AEM90-4N06	Uç / Insert	Takım Kodu / Tool Code
		4NKT 0603..	AEM90-4N06-D16-W16-L120-Z02-H AEM90-4N06-D16-W16-L160-Z02 AEM90-4N06-D20-W16-L120-Z03-H AEM90-4N06-D20-W16-L160-Z03 AEM90-4N06-D20-W20-L160-Z03
TGTC UCUNA UYGUNDUR. COMPATIBLE WITH TGTC INSERT.			

90°	AFM90-R390..	Uç / Insert	Takım Kodu / Tool Code
		R390-11T3.. R390-1704.. R390-1806..	AFM90-R390.11-D040-A16-Z05-H AFM90-R390.11-D050-A22-Z06-H AFM90-R390.11-D063-A22-Z07-H AFM90-R390.11-D080-A27-Z09-H AFM90-R390.17-D040-A16-Z04-H AFM90-R390.17-D050-A22-Z05-H AFM90-R390.17-D063-A22-Z06-H AFM90-R390.17-D080-A27-Z07-H AFM90-R390.17-D100-A32-Z08-H AFM90-R390.17-D125-B40-Z09 AFM90-R390.18-D050-A22-Z04-H AFM90-R390.18-D063-A22-Z05-H AFM90-R390.18-D080-A27-Z06-H AFM90-R390.18-D100-A32-Z07-H AFM90-R390.18-D125-B40-Z08
SNDVK UCUNA UYGUNDUR. COMPATIBLE WITH SNDVK INSERT.			

90°	AFM90-R290.12	Uç / Insert	Takım Kodu / Tool Code
		R290-12T3..	AFM90-R290.12-D050-A22-Z04-H AFM90-R290.12-D063-A22-Z05-H AFM90-R290.12-D080-A27-Z07-H AFM90-R290.12-D100-A32-Z09-H AFM90-R290.12-D125-B40-Z11
SNDVK UCUNA UYGUNDUR. COMPATIBLE WITH SNDVK INSERT.			

90°	AFM90-SP09T3	Uç / Insert	Takım Kodu / Tool Code
		SPMT 09T3..	AFM90-SP09T3-D040-A16-Z05-H AFM90-SP09T3-D050-A22-Z06-H AFM90-SP09T3-D063-A22-Z07-H AFM90-SP09T3-D080-A27-Z08-H
SNDVK UCUNA UYGUNDUR. COMPATIBLE WITH SNDVK INSERT.			

90°	AEM90-AX..	Uç / Insert	Takım Kodu / Tool Code
		AX.T 0602.. AX.T 0903..	AEM90-AX0602-D10-C09-L120-Z02 AEM90-AX0602-D10-C10-L080-Z02 AEM90-AX0602-D10-C10-L120-Z02 AEM90-AX0602-D12-C11-L120-Z02 AEM90-AX0602-D12-C12-L080-Z02 AEM90-AX0602-D12-C12-L120-Z02 AEM90-AX0602-D14-C12-L120-Z03 AEM90-AX0602-D16-W16-L120-Z04-H AEM90-AX0602-D16-W16-L150-Z04-H AEM90-AX0602-D20-W20-L120-Z05-H AEM90-AX0602-D20-W20-L150-Z05-H AEM90-AX0903-D16-C16-L120-Z02 AEM90-AX0903-D16-C16-L180-Z02 AEM90-AX0903-D17-C16-L120-Z02 AEM90-AX0903-D17-C16-L180-Z02 AEM90-AX0903-D20-C20-L120-Z03 AEM90-AX0903-D20-C20-L200-Z02 AEM90-AX0903-D21-C20-L120-Z03 AEM90-AX0903-D21-C20-L200-Z02 AEM90-AX0903-D25-C25-L150-Z03 AEM90-AX0903-D25-C25-L250-Z02 AEM90-AX0903-D26-C25-L150-Z03
TGTC UCUNA UYGUNDUR. COMPATIBLE WITH TGTC INSERT.			

90°	AEM90-AN1607	Uç / Insert	Takım Kodu / Tool Code
		AN.X 1607..	AEM90-AN1607-D32-C25-L150-Z02 AEM90-AN1607-D40-C32-L150-Z03
TGTC UCUNA UYGUNDUR. COMPATIBLE WITH TGTC INSERT.			

Frezeleme Takımları / Milling Tools

<p>90°</p> <p>AFM90-4N06</p>  <p>TGTC UCUNA UYGUNDUR. COMPATIBLE WITH TGTC INSERT.</p>	<p>Uç / Insert</p> <p>4NKT 0603..</p>	<p>Takım Kodu / Tool Code</p> <p>AFM90-4N06-D040-A16-Z05-H AFM90-4N06-D050-A22-Z06-H</p>	<p>90°</p> <p>AEM90-AP.</p>  <p>TGTC UCUNA UYGUNDUR. COMPATIBLE WITH TGTC INSERT.</p>	<p>Uç / Insert</p> <p>APKT 09T3..</p>	<p>Takım Kodu / Tool Code</p> <p>AEM90-AP09-D16-C16-L100-Z02-H AEM90-AP09-D16-C15-L150-Z02 AEM90-AP09-D16-W16-L150-Z02-H AEM90-AP09-D16-C16-L200-Z02-H AEM90-AP09-D17-C16-L150-Z02 AEM90-AP09-D17-C16-L180-Z02-H AEM90-AP09-D20-C20-L150-Z03-H AEM90-AP09-D20-C20-L200-Z03-H AEM90-AP09-D20-C20-L250-Z02-H AEM90-AP09-D21-C20-L150-Z03 AEM90-AP09-D21-C20-L180-Z02-H AEM90-AP09-D26-C25-L150-Z04</p>
<p>90°</p> <p>AEM90-3P..</p>  <p>TGTC UCUNA UYGUNDUR. COMPATIBLE WITH TGTC INSERT.</p>	<p>Uç / Insert</p> <p>3PT 060308</p> <p>3PT 100408</p> <p>3PT 150508</p>	<p>Takım Kodu / Tool Code</p> <p>AEM90-3P0603-D12-C12-L120-Z01-H AEM90-3P0603-D16-W16-L120-Z03-H AEM90-3P0603-D20-W20-L150-Z03-H AEM90-3P0603-D25-W25-L150-Z05-H AEM90-3P1004-D20-W20-L150-Z02 AEM90-3P1004-D21-C20-L200-Z02 AEM90-3P1004-D22-W20-L150-Z02 AEM90-3P1004-D25-W25-L150-Z03 AEM90-3P1004-D26-C25-L200-Z02 AEM90-3P1004-D26-C25-L250-Z02 AEM90-3P1004-D33-C32-L200-Z03 AEM90-3P1004-D33-C32-L250-Z03 AEM90-3P1505-D32-W32-L150-Z03 AEM90-3P1505-D38-W32-L150-Z03 AEM90-3P1505-D40-W32-L150-Z04</p>	<p>TGTC UCUNA UYGUNDUR. COMPATIBLE WITH TGTC INSERT.</p>	<p>Uç / Insert</p> <p>AP. 1204..</p> <p>AP. 1705..</p>	<p>Takım Kodu / Tool Code</p> <p>AEM90-AP1204-D20-C20-L150-Z02 AEM90-AP1204-D21-C20-L150-Z02 AEM90-AP1204-D21-C20-L200-Z02 AEM90-AP1204-D22-C20-L200-Z02 AEM90-AP1204-D25-C25-L150-Z03 AEM90-AP1204-D25-C25-L250-Z03 AEM90-AP1204-D26-C25-L250-Z02 AEM90-AP1204-D32-C25-L150-Z03 AEM90-AP1705-D25-C25-L120-Z02 AEM90-AP1705-D26-C25-L200-Z02 AEM90-AP1705-D26-C25-L250-Z02 AEM90-AP1705-D26-C25-L300-Z02 AEM90-AP1705-D28-W25-L075-Z02 AEM90-AP1705-D32-C25-L150-Z03 AEM90-AP1705-D33-C32-L250-Z03 AEM90-AP1705-D33-C32-L300-Z02</p>
<p>90°</p> <p>AEM90-3P1004</p>  <p>TGTC UCUNA UYGUNDUR. COMPATIBLE WITH TGTC INSERT.</p>	<p>Uç / Insert</p> <p>3PT 1004..</p>	<p>Takım Kodu / Tool Code</p> <p>AEM90-3P1004-D20-M10-L35-Z02 AEM90-3P1004-D32-M16-L43-Z05-H</p>	<p>90°</p> <p>AFM90-3P..</p>  <p>TGTC UCUNA UYGUNDUR. COMPATIBLE WITH TGTC INSERT.</p>	<p>Uç / Insert</p> <p>3PKT 1004..</p> <p>3PKT 1505..</p> <p>3PKT 1906..</p>	<p>Takım Kodu / Tool Code</p> <p>AFM90-3P1004-D040-A16-Z05-H AFM90-3P1004-D050-A22-Z06-H AFM90-3P1505-D050-A22-Z04-H AFM90-3P1505-D050-A22-Z05-H AFM90-3P1505-D063-A22-Z04-H AFM90-3P1505-D063-A22-Z06-H AFM90-3P1505-D080-A27-Z07-H AFM90-3P1505-D100-A32-Z08-H AFM90-3P1505-D125-B40-Z10 AFM90-3P1906-D080-A27-Z07-H AFM90-3P1906-D100-A32-Z08-H AFM90-3P1906-D125-B40-Z10</p>
<p>-°</p> <p>AEMR-RY..</p>  <p>TGTC UCUNA UYGUNDUR. COMPATIBLE WITH TGTC INSERT.</p>	<p>Uç / Insert</p> <p>RYMX 0803..</p> <p>RYMX 1004..</p> <p>RYMX 1205..</p>	<p>Takım Kodu / Tool Code</p> <p>AEMR-RY08-D16-W16-L150-Z02 AEMR-RY10-D20-W20-L150-Z02 AEMR-RY10-D20-C20-L200-Z02 AEMR-RY10-D21-W20-L200-Z02-H AEMR-RY10-D25-W25-L150-Z02 AEMR-RY10-D25-W25-L150-Z03 AEMR-RY10-D26-W25-L200-Z02-H AEMR-RY10-D32-W32-L160-Z04-H AEMR-RY12-D32-C25-L160-Z03</p>	<p>-°</p> <p>AHFM-BL..</p>  <p>TGTC UCUNA UYGUNDUR. COMPATIBLE WITH TGTC INSERT.</p>	<p>Uç / Insert</p> <p>BLMP 0603..</p> <p>BLMP 0904..</p>	<p>Takım Kodu / Tool Code</p> <p>AHFM-BL0603-D16-C15-L150-Z02 AHFM-BL0603-D16-C16-L100-Z02-H AHFM-BL0603-D16-C16-L150-Z02 AHFM-BL0603-D17-C16-L150-Z02 AHFM-BL0603-D17-W16-L170-Z02 AHFM-BL0603-D17-W16-L170-Z02-H AHFM-BL0603-D17-C16-L200-Z02 AHFM-BL0603-D18-C16-L150-Z02 AHFM-BL0603-D18-W16-L150-Z02-H AHFM-BL0603-D20-C20-L130-Z03 AHFM-BL0603-D20-C20-L160-Z03 AHFM-BL0603-D21-W20-L200-Z03 AHFM-BL0603-D21-C20-L200-Z03 AHFM-BL0603-D22-W20-L150-Z03 AHFM-BL0603-D25-C25-L250-Z04 AHFM-BL0603-D26-W25-L200-Z04 AHFM-BL0603-D26-C25-L200-Z04 AHFM-BL0603-D26-C25-L250-Z04 AHFM-BL0603-D30-C25-L150-Z05 AHFM-BL0603-D32-C32-L150-Z05 AHFM-BL0603-D32-C32-L200-Z05 AHFM-BL0603-D33-C32-L150-Z05 AHFM-BL0603-D33-C32-L200-Z05 AHFM-BL0603-D33-C32-L250-Z05 AHFM-BL0904-D28-W25-L180-Z03</p>
<p>-°</p> <p>AFMR-RY..</p>  <p>TGTC UCUNA UYGUNDUR. COMPATIBLE WITH TGTC INSERT.</p>	<p>Uç / Insert</p> <p>RYMX 1004..</p> <p>RYMX 1205..</p>	<p>Takım Kodu / Tool Code</p> <p>AFMR-RY10-D040-A16-Z04-H AFMR-RY10-D040-A16-Z05-H AFMR-RY10-D050-A22-Z05-H AFMR-RY10-D063-A22-Z06-H AFMR-RY12-D040-A16-Z04-H AFMR-RY12-D050-A22-Z05-H AFMR-RY12-D052-A22-Z05-H AFMR-RY12-D063-A22-Z06-H AFMR-RY12-D080-A27-Z06-H AFMR-RY12-D100-A32-Z07-H</p>	<p>-°</p> <p>AEMR-RY..</p>  <p>TGTC UCUNA UYGUNDUR. COMPATIBLE WITH TGTC INSERT.</p>	<p>Uç / Insert</p> <p>RYMX 1004..</p> <p>RYMX 1205..</p>	<p>Takım Kodu / Tool Code</p> <p>AEMR-RY10-D25-M12-L43-Z03-H AEMR-RY10-D32-M16-L43-Z04-H AEMR-RY10-D40-M16-L43-Z05-H AEMR-RY12-D32-M16-L43-Z03-H AEMR-RY12-D40-M16-L43-Z03-H</p>

-°	AHFM-BL..	Uç / Insert	Takım Kodu / Tool Code
		BLMP 0603	AHFM-BL0603-D17-M08-L35-Z02-H AHFM-BL0603-D20-M10-L30-Z03-H AHFM-BL0603-D21-M10-L35-Z03-H
		BLMP 0904	AHFM-BL0903-D25-M12-L35-Z04-H AHFM-BL0903-D32-M16-L40-Z05-H AHFM-BL0904-D32-M16-L40-Z04-H AHFM-BL0904-D32-M16-L43-Z04-H AHFM-BL0904-D42-M16-L43-Z05-H
TGTC UCUNA UYGUNDUR. COMPATIBLE WITH TGTC INSERT.			

-°	AHFM-BL..	Uç / Insert	Takım Kodu / Tool Code
		BLMP 0603..	AHFM-BL0603-D040-A16-Z06-H AHFM-BL0603-D050-A22-Z07-H
		BLMP 0904..	AHFM-BL0904-D040-A16-Z05-H AHFM-BL0904-D050-A22-Z06-H AHFM-BL0904-D063-A22-Z05-H AHFM-BL0904-D063-A22-Z07-H
TGTC UCUNA UYGUNDUR. COMPATIBLE WITH TGTC INSERT.			

90°	AHM90-AP1204	Uç / Insert	Takım Kodu / Tool Code
		AP.. 1204..	AHM90-AP1204-D32-W32-L140-Z0212-H AHM90-AP1204-D40-W32-L160-Z0321-H
		TGTC UCUNA UYGUNDUR. COMPATIBLE WITH TGTC INSERT.	

90°	AFM90-AP1705	Uç / Insert	Takım Kodu / Tool Code
		AP.. 1705..	AFM90-AP1705-D050-A22-Z05-H AFM90-AP1705-D063-A22-Z06-H AFM90-AP1705-D080-A27-Z07-H AFM90-AP1705-D100-A32-Z08-H
		TGTC UCUNA UYGUNDUR. COMPATIBLE WITH TGTC INSERT.	

-°	AHFM-BL1205	Uç / Insert	Takım Kodu / Tool Code
		BLMP 1205..	AHFM-BL1205-D050-A22-Z03-H AHFM-BL1205-D063-A22-Z04-H AHFM-BL1205-D080-A27-Z05-H
		TGTC UCUNA UYGUNDUR. COMPATIBLE WITH TGTC INSERT.	

45°	AFM45-SN1306	Uç / Insert	Takım Kodu / Tool Code
		SNGX 1306..	AFM45-SN1306-D050-A22-Z05-H AFM45-SN1306-D063-A22-Z06-H AFM45-SN1306-D080-A27-Z07-H AFM45-SN1306-D100-A32-Z08-H
		TGTC UCUNA UYGUNDUR. COMPATIBLE WITH TGTC INSERT.	

88°	AFM88-SN1306	Uç / Insert	Takım Kodu / Tool Code
		SNGX 1306..	AFM88-SN1306-D050-A22-Z05-H AFM88-SN1306-D063-A22-Z06-H AFM88-SN1306-D080-A27-Z07-H
		TGTC UCUNA UYGUNDUR. COMPATIBLE WITH TGTC INSERT.	

45°	AFM45-XN0906	Uç / Insert	Takım Kodu / Tool Code
		XNMM 0906..	AFM45-XN0906-D063-A22-Z06-H AFM45-XN0906-D080-A27-Z06-H AFM45-XN0906-D100-A32-Z07-H AFM45-XN0906-D125-B40-Z08
		TGTC UCUNA UYGUNDUR. COMPATIBLE WITH TGTC INSERT.	

90°	AFM90-TN2207	Uç / Insert	Takım Kodu / Tool Code
		TN.X 2207..	AFM90-TN2207-D063-A22-Z04-H AFM90-TN2207-D080-A27-Z05-H AFM90-TN2207-D100-B32-Z06 AFM90-TN2207-D125-B40-Z08
		TGTC UCUNA UYGUNDUR. COMPATIBLE WITH TGTC INSERT.	

90°	AFM90-TP2205	Uç / Insert	Takım Kodu / Tool Code
		TPKT 2205..	AFM90-TP2205-D063-A22-Z04 AFM90-TP2205-D080-A27-Z06 AFM90-TP2205-D100-A32-Z07 AFM90-TP2205-D125-B40-Z08 AFM90-TP2205-D160-C40-Z09 AFM90-TP2205-D200-C60-Z12
		TGTC UCUNA UYGUNDUR. COMPATIBLE WITH TGTC INSERT.	

90°	ATSM90-SP..	Uç / Insert	Takım Kodu / Tool Code
		SPMG 050204	ATSM90-SP.05-D22.5X5-W25-L100-Z04 ATSM90-SP.05-D25X5-W25-L100-Z04 ATSM90-SP.05-D30X5-W25-L100-Z04
		SPMG 060204	ATSM90-SP.06-D80X7-W32-L120-Z10
TGTC UCUNA UYGUNDUR. COMPATIBLE WITH TGTC INSERT.			

-°	AHFM-LN0303	Uç / Insert	Takım Kodu / Tool Code
		LNMU 0303..	AHFM-LN0303-D16-C15-L150-Z02 AHFM-LN0303-D16-W16-L150-Z02-H AHFM-LN0303-D17-C16-L150-Z02-H AHFM-LN0303-D20-W20-L150-Z03-H AHFM-LN0303-D21-C20-L150-Z03 AHFM-LN0303-D25-W25-L150-Z04-H AHFM-LN0303-D26-C25-L150-Z04 AHFM-LN0303-D28-C25-L180-Z03 AHFM-LN0303-D33-C32-L200-Z05
		TNGLY UCUNA UYGUNDUR. COMPATIBLE WITH TNGLY INSERT.	

-°	AHFM-LN0303	Uç / Insert	Takım Kodu / Tool Code
		LNMU 0303..	AHFM-LN0303-D25-M12-L35-Z04-H AHFM-LN0303-D32-M16-L43-Z05-H AHFM-LN0303-D42-M16-L43-Z06-H
		TNGLY UCUNA UYGUNDUR. COMPATIBLE WITH TNGLY INSERT.	

-°	AHFM-LN0303	Uç / Insert	Takım Kodu / Tool Code
		LNMU 0303..	AHFM-LN0303-D040-A16-Z06-H AHFM-LN0303-D050-A22-Z07-H AHFM-LN0303-D063-A22-Z09-H
		TNGLY UCUNA UYGUNDUR. COMPATIBLE WITH TNGLY INSERT.	

Frezeleme Takımları / Milling Tools

90°	AFM90-TN1207	Uç / Insert	Takım Kodu / Tool Code	88°	AFM88C-SN1204	Uç / Insert	Takım Kodu / Tool Code
	TN1207..	AFM90-TN1207-D050-A22-Z04-H AFM90-TN1207-D063-A22-Z05-H AFM90-TN1207-D080-A27-Z06-H AFM90-TN1207-D100-A32-Z07-H AFM90-TN1207-D125-B40-Z08			SN.. 1204..	AFM88C-SN1204-D050-A22-Z05 AFM88C-SN1204-D063-A22-Z06 AFM88C-SN1204-D080-A27-Z07 AFM88C-SN1204-D100-A32-Z08 AFM88C-SN1204-D125-B40-Z11	
TNGLY UCUNA UYGUNDUR. COMPATIBLE WITH TNGLY INSERT.				UNIN UCUNA UYGUNDUR. COMPATIBLE WITH UNIN INSERT.			
-°	ATM-3BEI	Uç / Insert	Takım Kodu / Tool Code	-°	AHFM-XD0904WD	Uç / Insert	Takım Kodu / Tool Code
	3BEI.. 3E./3I..	ATM-3BEI-D21-W25-L100-Z01-H ATM-3EI-D14-W20-L90-Z01-H ATM-3EI-D20-W25-L120-Z01-H			XD.. 0904..	AHFM-XD0904WD-D26-M12-L35-Z03-H AHFM-XD0904WD-D33-M16-L43-Z04-H	
VRGS UCUNA UYGUNDUR. COMPATIBLE WITH VRGS INSERT.							
45°	AFM45-HN0905	Uç / Insert	Takım Kodu / Tool Code	45°	AFM45C-HN0905	Uç / Insert	Takım Kodu / Tool Code
	HN.. 0905..	AFM45-HN0905-D050-A22-Z05-H AFM45-HN0905-D063-A22-Z06-H AFM45-HN0905-D080-A27-Z07-H AFM45L-HN0905-D100-A32-Z08-H AFM45-HN0905-D125-B40-Z10 AFM45L-HN0905-D125-B40-Z10 AFM45-HN0905-D160-C40-Z12 AFM45L-HN0905-D160-C40-Z12 AFM45-HN0905-D200-C60-Z16 AFM45L-HN0905-D200-C60-Z16			HN.. 0905..	AFM45C-HN0905-D063-A22-Z07 AFM45C-HN0905-D080-A27-Z09 AFM45C-HN0905-D100-A32-Z11 AFM45C-HN0905-D125-B40-Z13 AFM45CL-HN0905-D125-B40-Z10 AFM45C-HN0905-D160-C40-Z15	
WDA UCUNA UYGUNDUR. COMPATIBLE WITH WDA INSERT.				WDA UCUNA UYGUNDUR. COMPATIBLE WITH WDA INSERT.			
90°	AEM90-AD..	Uç / Insert	Takım Kodu / Tool Code	90°	AFM90-AD10T3	Uç / Insert	Takım Kodu / Tool Code
	ADMT 0803..	AEM90-AD0803-D16-W16-L150-Z02 AEM90-AD0803-D17-W16-L150-Z02 AEM90-AD0803-D17-W16-L200-Z02 AEM90-AD0803-D20-W20-L150-Z03 AEM90-AD0803-D21-W20-L200-Z03 AEM90-AD10T3-D16-W16-L100-Z02-H AEM90-AD10T3-D16-W16-L150-Z02 AEM90-AD10T3-D16-C16-L200-Z02 AEM90-AD10T3-D17-W16-L150-Z02 AEM90-AD10T3-D17-W16-L200-Z02 AEM90-AD10T3-D20-W20-L70-Z03 AEM90-AD10T3-D20-W20-L100-Z03-H AEM90-AD10T3-D20-C20-L150-Z03 AEM90-AD10T3-D20-W20-L150-Z03 AEM90-AD10T3-D20-C20-L200-Z03 AEM90-AD10T3-D25-W25-L100-Z03-H AEM90-AD10T3-D25-W25-L100-Z04-H AEM90-AD10T3-D25-W25-L150-Z03 AEM90-AD1204-D20-W20-L150-Z02 AEM90-AD1204-D22-C20-L150-Z02 AEM90-AD1204-D25-W25-L150-Z03 AEM90-AD1204-D26-W25-L180-Z03 AEM90-AD1204-D32-W32-L150-Z04 AEM90-AD1606-D25-W25-L150-Z02 AEM90-AD1606-D32-W32-L150-Z03			ADMT 10T3..	AFM90-AD10T3-D040-A16-Z06-H AFM90-AD10T3-D050-A22-Z07-H	
WLTR UCUNA UYGUNDUR. COMPATIBLE WITH WLTR INSERT.				WDA UCUNA UYGUNDUR. COMPATIBLE WITH WDA INSERT.			
-°	APMR-PR..	Uç / Insert	Takım Kodu / Tool Code	-°	APMR-P32..	Uç / Insert	Takım Kodu / Tool Code
	new P3210 new P3212 P3216 P3220 P3225 P3232	APMR-P3210-D10-M06-L20 APMR-P3212-D12-M06-L20 APMR-P3216-D16-M08-L25 APMR-P3220-D20-M10-L30 APMR-P3225-D25-M12-L35 APMR-P3232-D32-M16-L43			P3208 P3210 P3212 P3216 P3220 P3225 P3232	APMR-P3208-D08-C10-L110 APMR-P3210-D10-C10-L130 APMR-P3210-D10-C12-L130 APMR-P3212-D12-C12-L130 APMR-P3216-D16-C16-L175 APMR-P3220-D20-C20-L200 APMR-P3225-D25-C25-L200 APMR-P3232-D32-C32-L200	
WLTR UCUNA UYGUNDUR. COMPATIBLE WITH WLTR INSERT.				WLTR UCUNA UYGUNDUR. COMPATIBLE WITH WLTR INSERT.			
43°	AFM43C-OD0504	Uç / Insert	Takım Kodu / Tool Code	43°	AFM43-OD0504	Uç / Insert	Takım Kodu / Tool Code
	OD.. 0504..	AFM43C-OD0504-D080-A27-Z06-H AFM43C-OD0504-D100-A32-Z07-H AFM43C-OD0504-D125-B40-Z08			OD.. 0504..	AFM43-OD0504-D040-A16-Z04-H AFM43-OD0504-D050-A22-Z05-H AFM43-OD0504-D063-A22-Z06-H AFM43-OD0504-D080-A27-Z07-H AFM43-OD0504-D100-A32-Z08-H	
WLTR UCUNA UYGUNDUR. COMPATIBLE WITH WLTR INSERT.				WLTR UCUNA UYGUNDUR. COMPATIBLE WITH WLTR INSERT.			

45°	AFM45C-SN..	Uç / Insert	Takım Kodu / Tool Code
		SN.. 12....	AFM45C-SN12..-D050-A22-Z04-H
			AFM45C-SN12..-D050-A22-Z05-H
			AFM45C-SN12..-D063-A22-Z06-H
			AFM45C-SN12..-D063-A22-Z07-H
			AFM45CL-SN12..-D063-A22-Z07-H
			AFM45C-SN12..-D080-A27-Z07-H
			AFM45C-SN12..-D080-A27-Z08-H
			AFM45CL-SN12..-D080-A27-Z08-H
			AFM45C-SN12..-D100-A32-Z08-H
			AFM45C-SN12..-D100-A32-Z10-H
			AFM45CL-SN12..-D100-A32-Z10-H
			AFM45C-SN12..-D125-B40-Z11
			AFM45CL-SN12..-D125-B40-Z11
			AFM45C-SN12..-D160-C40-Z12
			AFM45C-SN12..-D200-C60-Z14
AFM45CL-SN12..-D200-C60-Z14			

WLTR UCUNA UYGUNDUR.
COMPATIBLE WITH WLTR INSERT.

-°	AFMRC-RO20	Uç / Insert	Takım Kodu / Tool Code
		ROMX 2006..	AFMRC-RO20-D063-A22-Z05-H
			AFMRC-RO20-D080-A27-Z06-H

WLTR UCUNA UYGUNDUR.
COMPATIBLE WITH WLTR INSERT.

90°	AFM90-AN..	Uç / Insert	Takım Kodu / Tool Code
		ANKX 1207..	AFM90-AN1207-D040-A16-Z04-H
			AFM90-AN1207-D050-A22-Z05-H
			AFM90-AN1207-D063-A22-Z06-H
		ANKX 1607..	AFM90-AN1607X-D050-A22-Z04-H
			AFM90-AN1607X-D063-A22-Z06-H
			AFM90-AN1607X-D080-A27-Z07-H

XTC-GSC UCUNA UYGUNDUR.
COMPATIBLE WITH XTC-GSC INSERT.

90°	AEM90-LN1106	Uç / Insert	Takım Kodu / Tool Code
		LNMT 1106..	AEM90-LN1106-D25-W25-L150-Z03
			AEM90-LN1106-D32-W32-L150-Z04
			AEM90-LN1106-D40-W32-L150-Z05

XTC-GSC UCUNA UYGUNDUR.
COMPATIBLE WITH XTC-GSC INSERT.

90°	AEM90-WNG04..	Uç / Insert	Takım Kodu / Tool Code
		WNGU 0403....	AEM90-WNG04-D20-W20-L81-Z02-H
			AEM90-WNG04-D20-W20-L81-Z03-H
			AEM90-WNG04-D20-C20-L170-Z02-H
			AEM90-WNG04-D20-C20-L170-Z03-H
			AEM90-WNG04-D25-W25-L88-Z03-H
			AEM90-WNG04-D25-W25-L88-Z04-H
			AEM90-WNG04-D25-C25-L170-Z02-H
			AEM90-WNG04-D25-C25-L170-Z03-H
			AEM90-WNG04-D32-W25-L100-Z05-H
		AEM90-WNG04-D32-W32-L100-Z05-H	
		AEM90-WNG04-D32-C32-L170-Z03-H	
		AEM90-WNG04-D32-C25-L170-Z04-H	
		AEM90-WNG04-D32-C32-L170-Z04-H	
		WNGU 0806..	AEM90-WNG08-D32-C32-L170-Z02-H
			AEM90-WNG08-D40-W32-L100-Z03-H
			AEM90-WNG08-D40-W40-L110-Z03-H
			AEM90-WNG08-D40-C32-L170-Z03-H

XTC-GSC UCUNA UYGUNDUR.
COMPATIBLE WITH XTC-GSC INSERT.

90°	AFM90-WNG	Uç / Insert	Takım Kodu / Tool Code
		WNGU 0403..	AFM90-WNG04-D040-A16-Z06-H
			AFM90-WNG04-D050-A22-Z05-H
			AFM90-WNG04-D050-A22-Z07-H
			AFM90-WNG04-D063-A22-Z06-H
			AFM90-WNG08-D050-A22-Z05-H
			AFM90-WNG08-D063-A22-Z06-H
		WNGU 0806..	AFM90-WNG08-D080-A27-Z07-H
			AFM90-WNG08-D100-A32-Z07-H

XTC-GSC UCUNA UYGUNDUR.
COMPATIBLE WITH XTC-GSC INSERT.

90°	AFM90-LN1306W	Uç / Insert	Takım Kodu / Tool Code
		LNHU 1306..	AFM90-LN1306W-D040-A16-Z04-H
			AFM90-LN1306W-D050-A22-Z05-H
			AFM90-LN1306W-D063-A22-Z06-H
			AFM90-LN1306W-D080-A27-Z07-H
			AFM90-LN1306W-D100-A32-Z08-H

WLTR UCUNA UYGUNDUR.
COMPATIBLE WITH WLTR INSERT.

90°	AFM90-LN1307	Uç / Insert	Takım Kodu / Tool Code
		LNGX 1307..	AFM90-LN1307-D050-A22-Z04-H
			AFM90-LN1307-D063-A22-Z06-H
			AFM90-LN1307-D080-A27-Z07-H
			AFM90-LN1307-D100-A32-Z08-H

WLTR UCUNA UYGUNDUR.
COMPATIBLE WITH WLTR INSERT.

-°	AEMR-RO10..	Uç / Insert	Takım Kodu / Tool Code
		RO..10T3..	AEMR-RO10-D20-M10-L30-Z02-H
			AEMR-RO10-D25-M12-L35-Z03-H
			AEMR-RO10-D32-M16-L40-Z04-H
			AEMR-RO10-D35-M16-L40-Z04-H
			AEMR-RO10-D42-M16-L40-Z05-H

WLTR UCUNA UYGUNDUR.
COMPATIBLE WITH WLTR INSERT.

90°	AEM90-AN1207	Uç / Insert	Takım Kodu / Tool Code
		ANKX 1207..	AEM90-AN1207-D25-W25-L150-Z02
			AEM90-AN1207-D32-W32-L150-Z03
			AEM90-AN1207-D40-W32-L150-Z04

XTC-GSC UCUNA UYGUNDUR.
COMPATIBLE WITH XTC-GSC INSERT.

90°	AEM90-AP1135	Uç / Insert	Takım Kodu / Tool Code
		AP. 1135..	AEM90-AP1135-D16-W16-L110-Z02-H
			AEM90-AP1135-D16-W16-L150-Z03
			AEM90-AP1135-D20-W20-L125-Z03-H
			AEM90-AP1135-D20-W20-L150-Z03
			AEM90-AP1135-D25-W25-L125-Z04-H
			AEM90-AP1135-D25-W25-L200-Z04-H
		APKT 1135..	AEM90-AP1135-D32-W32-L125-Z05-H
			AEM90-AP1135-D32-W32-L200-Z04-H
			AEM90-AP1135G-D16-W16-L150-Z02
			AEM90-AP1135G-D20-W20-L150-Z03
			AEM90-AP1135G-D25-W25-L150-Z03

XTC-GSC UCUNA UYGUNDUR.
COMPATIBLE WITH XTC-GSC INSERT.

90°	AFM90-LN1506X	Uç / Insert	Takım Kodu / Tool Code
		LNMT 1506..	AFM90-LN1506X-D063-A22-Z06
			AFM90-LN1506X-D080-A27-Z07
			AFM90-LN1506X-D100-A32-Z08

XTC-GSC UCUNA UYGUNDUR.
COMPATIBLE WITH XTC-GSC INSERT.

90°	AEM90-AP1135Y	Uç / Insert	Takım Kodu / Tool Code
		APMT 1135..	AEM90-AP1135Y-D16-C16-L120-Z02-H
			AEM90-AP1135Y-D16-W16-L150-Z02
			AEM90-AP1135Y-D17-C16-L150-Z02
			AEM90-AP1135Y-D20-C20-L120-Z02
			AEM90-AP1135Y-D20-W20-L150-Z03
			AEM90-AP1135Y-D21-C20-L150-Z03
			AEM90-AP1135Y-D25-W25-L150-Z03
			AEM90-AP1135Y-D25-C25-L150-Z04-H
			AEM90-AP1135Y-D26-C25-L150-Z03
		AP. 1604..	AEM90-AP1135Y-D32-W25-L110-Z04
			AEM90-AP16Y-D25-C20-L100-Z02-H
			AEM90-AP16Y-D25-C25-L120-Z02
			AEM90-AP16Y-D25-C25-L150-Z02
			AEM90-AP16Y-D25-C25-L250-Z02

YG UCUNA UYGUNDUR.
COMPATIBLE WITH YG INSERT.

Frezeleme Takımları / Milling Tools

90°	AFM90-AP16Y	Uç / Insert	Takım Kodu / Tool Code	90°	AEM90-AN11	Uç / Insert	Takım Kodu / Tool Code
	AP. 1604..		AFM90-AP16Y-D040-A16-Z04-H AFM90-AP16Y-D050-A22-Z05-H AFM90-AP16Y-D063-A22-Z06-H AFM90-AP16Y-D080-A27-Z07-H AFM90-AP16Y-D100-A32-Z08-H		ANGX 110508		AEM90-AN11-D22-W20-L150-Z02 AEM90-AN11-D25-W25-L150-Z02 AEM90-AN11-D25-C25-L200-Z02 AEM90-AN11-D26-W25-L150-Z02 AEM90-AN11-D28-W25-L150-Z02 AEM90-AN11-D32-W32-L150-Z03 AEM90-AN11-D32-C32-L200-Z03 AEM90-AN11-D40-W32-L150-Z04
YG UCUNA UYGUNDUR. COMPATIBLE WITH YG INSERT.				ZCC UCUNA UYGUNDUR. COMPATIBLE WITH ZCC INSERT.			
90°	AFM90-AN..	Uç / Insert	Takım Kodu / Tool Code	90°	AEM90-SE09	Uç / Insert	Takım Kodu / Tool Code
	ANGX 1105.. ANGX 150608		AFM90-AN11-D040-A16-Z04-H AFM90-AN1506-D050-A22-Z04-H AFM90-AN1506-D063-A22-Z05-H AFM90-AN1506-D080-A27-Z06-H AFM90-AN1506-D100-A32-Z08-H AFM90-AN1506-D125-B40-Z12 AFM90-AN1506-D160-C40-Z14		SEET 09T3..		AEM90-SE09-D25-C25-L120-Z03-H AEM90-SE09-D25-C25-L150-Z02 AEM90-SE09-D32-C32-L120-Z04-H AEM90-SE09-D32-C32-L150-Z03
ZCC UCUNA UYGUNDUR. COMPATIBLE WITH ZCC INSERT.				ZCC UCUNA UYGUNDUR. COMPATIBLE WITH ZCC INSERT.			
90°	AFM90-SE09	Uç / Insert	Takım Kodu / Tool Code	90°	AFM90-SE12	Uç / Insert	Takım Kodu / Tool Code
	SEET 09T3..		AFM90-SE09-D040-A16-Z04-H AFM90-SE09-D050-A22-Z05-H AFM90-SE09-D063-A22-Z06-H		SEET 1203..		AFM90-SE12-D050 A22 Z04-H AFM90-SE12-D063 A22 Z05-H AFM90-SE12-D080 A27 Z07-H AFM90-SE12-D100 A32 Z09-H AFM90-SE12-D125 B40 Z11
ZCC UCUNA UYGUNDUR. COMPATIBLE WITH ZCC INSERT.				ZCC UCUNA UYGUNDUR. COMPATIBLE WITH ZCC INSERT.			
90°	AEM90-AP11	Uç / Insert	Takım Kodu / Tool Code	90°	AFM90-SE12	Uç / Insert	Takım Kodu / Tool Code
	AP. 11T3...		AEM90-AP11-D16-C16-L150-Z02 AEM90-AP11-D16-C16-L150-Z02-H AEM90-AP11-D16-W16-L150-Z02 AEM90-AP11-D16-W16-L150-Z02-H AEM90-AP11-D16-C16-L200-Z02 AEM90-AP11-D17-C16-L150-Z02 AEM90-AP11-D17-C16-L200-Z02 AEM90-AP11-D20-C20-L150-Z03 AEM90-AP11-D20-W20-L150-Z03 AEM90-AP11-D20-W20-L150-Z03-H AEM90-AP11-D20-C20-L200-Z03 AEM90-AP11-D21-C20-L150-Z03 AEM90-AP11-D21-W20-L150-Z03 AEM90-AP11-D21-W20-L150-Z03-H AEM90-AP11-D21-C20-L200-Z03 AEM90-AP11-D22-C20-L180-Z03-H AEM90-AP11-D25-C25-L150-Z03 AEM90-AP11-D25-W25-L150-Z03 AEM90-AP11-D25-W25-L150-Z03-H AEM90-AP11-D26-C25-L150-Z03 AEM90-AP11-D26-C24-L150-Z03 AEM90-AP11-D28-C25-L180-Z03-H AEM90-AP11-D32-W25-L150-Z04 AEM90-AP11-D32-W32-L150-Z03-H AEM90-AP11-D32-W32-L150-Z04		AP. 11T3..		AEM90-AP11-D16-M08-L30-Z02-H AEM90-AP11-D20-M10-L30-Z03-H AEM90-AP11-D25-M12-L35-Z03-H AEM90-AP11-D32-M16-L35-Z04-H AEM90-AP11-D40-M16-L43-Z05-H
ZCC UCUNA UYGUNDUR. COMPATIBLE WITH ZCC INSERT.				ZCC UCUNA UYGUNDUR. COMPATIBLE WITH ZCC INSERT.			
90°	AEM90-SPGT	Uç / Insert	Takım Kodu / Tool Code	90°	AEM90-AZ11..	Uç / Insert	Takım Kodu / Tool Code
	SPGT 0602.. SPGT 07T3.. SPGT 0904..		AEM90-SPGT0602-D16-W16-L150-Z02 AEM90-SPGT07T3-D20-W20-L150-Z03 AEM90-SPGT07T3-D25-W25-L150-Z03 AEM90-SPGT0904-D30-W32-L150-Z03		AZGT 1135..		AEM90-AZ11-D12-W16-L90-Z01 AEM90-AZ11-D16-C16-L200-Z02 AEM90-AZ11-D16-W15-L170-Z02 AEM90-AZ11-D16-W16-L100-Z02 AEM90-AZ11-D16-W16-L150-Z02 AEM90-AZ11-D17-C16-L150-Z02 AEM90-AZ11-D17-C16-L180-Z02 AEM90-AZ11-D17-W16-L100-Z02 AEM90-AZ11-D18-W16-L120-Z02 AEM90-AZ11-D20-C20-L200-Z03 AEM90-AZ11-D20-W19-L170-Z03 AEM90-AZ11-D20-W20-L110-Z02 AEM90-AZ11-D21-C20-L150-Z03 AEM90-AZ11-D21-C20-L180-Z03 AEM90-AZ11-D21-W20-L110-Z03 AEM90-AZ11-D22-C20-L150-Z02 AEM90-AZ11-D25-C24-L180-Z04 AEM90-AZ11-D25-W25-L110-Z04 AEM90-AZ11-D26-C25-L250-Z02 AEM90-AZ11-D26-W25-L120-Z03 AEM90-AZ11-D26-W25-L120-Z04 AEM90-AZ11-D28-C25-L180-Z03 AEM90-AZ11-D28-C25-L250-Z02 AEM90-AZ11-D33-W32-L130-Z04
ZCC UCUNA UYGUNDUR. COMPATIBLE WITH ZCC INSERT.				ZCC UCUNA UYGUNDUR. COMPATIBLE WITH ZCC INSERT.			

90°	ATSM90-SP..	Uç / Insert	Takım Kodu / Tool Code
		SPGT 050204	ATSM90-SPGT0502-D63X6-W32-L125-Z10
		SPGT 090408	ATSM90-SPGT0904-D32X14-W32-L120-Z04-H
			ATSM90-SPGT0904-D37X16-W32-L120-Z04-H
		SPGT 110408	ATSM90-SPGT0904-D42X17-W32-L120-Z04-H
ZCC UCUNA UYGUNDUR. COMPATIBLE WITH ZCC INSERT.			

45°	ACM45-SP11	Uç / Insert	Takım Kodu / Tool Code
		SPGT 110408	ACM45-SP1104-D12x26-W20-L150-Z01
			ACM45-SP1104-D25x39-W25-L150-Z02
			ACM45-SP1104-D32x46-W32-L150-Z03
ZCC UCUNA UYGUNDUR. COMPATIBLE WITH ZCC INSERT.			

90°	ASDM-SPGT	Uç / Insert	Takım Kodu / Tool Code
		SPGT 0502..	ASDM-SPGT05-D80x6-d27-Z10
			ASDM-SPGT05-D100x6-d32-Z12
			ASDM-SPGT05-D125x6-d40-Z14
			ASDM-SPGT05-D160x6-d40-Z18
		SPGT 0602..	ASDM-SPGT06-D80x7-d27-Z10
			ASDM-SPGT06-D100x7-d32-Z12
			ASDM-SPGT06-D125x7-d40-Z14
			ASDM-SPGT06-D160x7-d40-Z16
		SPGT 0702..	ASDM-SPGT06-D200x7-d40-Z18
			ASDM-SPGT07-D100x10-d27-Z10
ZCC UCUNA UYGUNDUR. COMPATIBLE WITH ZCC INSERT.			

90°	AEM90L-WN0604Z	Uç / Insert	Takım Kodu / Tool Code
		WNHU 0604..	AEM90L-WN0604Z-D25-C25-L200-Z02-H
			AEM90-WN0604Z-D25-W25-L150-Z02-H
			AEM90-WN0604Z-D32-W32-L150-Z03-H
			AEM90-WN0604Z-D40-W32-L150-Z04-H
ZCC UCUNA UYGUNDUR. COMPATIBLE WITH ZCC INSERT.			

90°	AEM90-WN0604Z	Uç / Insert	Takım Kodu / Tool Code
		WNHU 0604..	AEM90-WN0604Z-D25-M12-L35-Z02-H
			AEM90-WN0604Z-D32-M16-L43-Z03-H
			AEM90-WN0604Z-D40-M16-L43-Z04-H
ZCC UCUNA UYGUNDUR. COMPATIBLE WITH ZCC INSERT.			

90°	AFM90-WN..	Uç / Insert	Takım Kodu / Tool Code
		WNHU 0604..	AFM90-WN0604Z-D040-A16-Z04-H
			AFM90-WN0604Z-D050-A22-Z05-H
			AFM90-WN0604Z-D063-A22-Z06-H
			AFM90-WN0604Z-D080-A27-Z07-H
		WNHU 0806..	AFM90-WN0604Z-D100-A32-Z09-H
			AFM90-WN0806Z-D050-A22-Z04-H
			AFM90-WN0806Z-D063-A22-Z05-H
			AFM90-WN0806Z-D080-A27-Z06-H
			AFM90-WN0806Z-D100-A32-Z08-H
			AFM90-WN0806Z-D125-B40-Z10
ZCC UCUNA UYGUNDUR. COMPATIBLE WITH ZCC INSERT.			

-°	AHFM-SD..	Uç / Insert	Takım Kodu / Tool Code
		SD.. 06T2..	AHFM-SD06T2-D16-C16-L100-Z02-H
			AHFM-SD06T2-D16-C16-L150-Z02-H
			AHFM-SD06T2-D16-C16-L200-Z02
			AHFM-SD06T2-D17-C16-L150-Z02-H
			AHFM-SD06T2-D20-C20-L150-Z03-H
			AHFM-SD06T2-D20-C20-L200-Z03
			AHFM-SD06T2-D21-C20-L150-Z03-H
			AHFM-SD06T2-D25-C25-L150-Z04-H
			AHFM-SD06T2-D26-C25-L150-Z04-H
			AHFM-SD09T3-D22-W20-L150-Z02
			AHFM-SD09T3-D25-C25-L150-Z02
			AHFM-SD09T3-D25-W25-L150-Z02
		AHFM-SD09T3-D25-C25-L150-Z03	
		SD.. 09T3..	AHFM-SD09T3-D28-C25-L150-Z02
			AHFM-SD09T3-D32-C32-L150-Z03
			AHFM-SD09T3-D32-W32-L150-Z03
			AHFM-SD09T3-D32-C32-L150-Z04
ZCC UCUNA UYGUNDUR. COMPATIBLE WITH ZCC INSERT.			

-°	AHFM-SD..	Uç / Insert	Takım Kodu / Tool Code
		SD.. 06T2..	AHFM-SD06T2-D16-M08-L23-Z02-H
			AHFM-SD06T2-D20-M10-L30-Z03-H
			AHFM-SD06T2-D25-M12-L35-Z04-H
			AHFM-SD09T3-D25-M12-L30-Z02-H
			AHFM-SD09T3-D32-M16-L43-Z03-H
			AHFM-SD09T3-D40-M16-L43-Z04-H
SD.. 09T3..	AHFM-SD09T3-D35-M16-L43-Z03-H		
	AHFM-SD09T3-D40-M16-L43-Z04-H		
SD.. 1204..	AHFM-SD1204-D32-M16-L43-Z02-H		
	AHFM-SD1204-D40-M16-L43-Z03-H		
ZCC UCUNA UYGUNDUR. COMPATIBLE WITH ZCC INSERT.			

-°	AEMR-RC10T3	Uç / Insert	Takım Kodu / Tool Code
		RC.. 10T3..	AEMR-RC10T3-D25-M12-L35-Z03-H
			AEMR-RC10T3-D32-M16-L43-Z04-H
			AEMR-RC10T3-D40-M16-L43-Z05-H
ZCC UCUNA UYGUNDUR. COMPATIBLE WITH ZCC INSERT.			

-°	AHFM-SD1204	Uç / Insert	Takım Kodu / Tool Code
		SD.. 1204..	AHFM-SD1204-D050-A22-Z04-H
			AHFM-SD1204-D063-A22-Z05-H
			AHFM-SD1204-D080-A27-Z06-H
			AHFM-SD1204-D100-A32-Z08-H
ZCC UCUNA UYGUNDUR. COMPATIBLE WITH ZCC INSERT.			

-°	APMR-RO..	Uç / Insert	Takım Kodu / Tool Code
		ROHX 1203	APMR-RO12-D12-C12-L120
			APMR-RO12-D12-C16-L160
			APMR-RO16-D16-C16-L160
		ROHX 1604	APMR-RO16-D16-C16-L200
			APMR-RO16-D16-C20-L200
		ROHX 2005	APMR-RO20-D20-C20-L160
	APMR-RO20-D20-C20-L200		
			APMR-RO20-D20-C25-L220
ZCC UCUNA UYGUNDUR. COMPATIBLE WITH ZCC INSERT.			

-°	AFMR-RC10T3	Uç / Insert	Takım Kodu / Tool Code
		RC.. 10T3..	AFMR-RC10T3-D040-A16-Z04-H
			AFMR-RC10T3-D050-A22-Z05-H
			AFMR-RC10T3-D063-A22-Z06-H
ZCC UCUNA UYGUNDUR. COMPATIBLE WITH ZCC INSERT.			

-°	APMR-XP..	Uç / Insert	Takım Kodu / Tool Code
		XPHT 16R0803	APMR-XP16-D16-C16-L150
		XPHT 20R10T3	APMR-XP20-D20-C20-L150
		XPHT 25R1204	APMR-XP25-D25-C25-L150
ZCC UCUNA UYGUNDUR. COMPATIBLE WITH ZCC INSERT.			

Frezeleme Takımları / Milling Tools

-°	APMR-XP..	Uç / Insert	Takım Kodu / Tool Code	43°	AFM43-ON0604	Uç / Insert	Takım Kodu / Tool Code
		XPHT 16R0803 XPHT 20R10T3 XPHT 25R1204	APMR-XP16-D16-M08-L25 APMR-XP20-D20-M10-L30 APMR-XP25-D25-M12-L40			ON.. 0604..	AFM43-ON0604-D050-A22-Z05-H AFM43-ON0604-D063-A22-Z06-H AFM43-ON0604-D080-A27-Z07-H AFM43-ON0604-D100-A32-Z08-H AFM43-ON0604-D125-B40-Z09
ZCC UCUNA UYGUNDUR. COMPATIBLE WITH ZCC INSERT.				ZCC UCUNA UYGUNDUR. COMPATIBLE WITH ZCC INSERT.			
45°	AFM45-SE..	Uç / Insert	Takım Kodu / Tool Code	45°	AFM45C-SN12Z	Uç / Insert	Takım Kodu / Tool Code
		SE.. 12T3.. R245-12T3..	AFM45-SE12-D050-A22-Z04-H AFM45L-SE12-D050-A22-Z04-H AFM45-SE12-D063-A22-Z05-H AFM45L-SE12-D063-A22-Z05-H AFM45-SE12-D080-A27-Z06-H AFM45L-SE12-D080-A27-Z06-H AFM45-SE12-D100-A32-Z07-H AFM45L-SE12-D100-A32-Z07-H AFM45-SE12-D125-B40-Z08 AFM45L-SE12-D125-B40-Z08 AFM45-SE12-D160-C40-Z10 AFM45L-SE12-D160-C40-Z10 AFM45-SE12-D200-C60-Z12			SNEG 1205..	AFM45C-SN12Z-D050-A22-Z05-H AFM45C-SN12Z-D063-A22-Z06-H AFM45C-SN12Z-D080-A27-Z07-H AFM45C-SN12Z-D100-A32-Z09-H AFM45C-SN12Z-D125-B40-Z11 AFM45C-SN12Z-D160-C40-Z12 AFM45C-SN12Z-D200-C60-Z14
ZCC UCUNA UYGUNDUR. COMPATIBLE WITH ZCC INSERT.				ZCC UCUNA UYGUNDUR. COMPATIBLE WITH ZCC INSERT.			
90°	AFM90-LN15Z	Uç / Insert	Takım Kodu / Tool Code	88°	AFM88C-SN12Z	Uç / Insert	Takım Kodu / Tool Code
		LNKT 1506..	AFM90-LN15Z-D050-A22-Z04 AFM90-LN15Z-D063-A22-Z05 AFM90-LN15Z-D080-A27-Z06 AFM90-LN15Z-D100-A32-Z07 AFM90-LN15Z-D125-B40-Z08			SNEG 1205..	AFM88C-SN12Z-D063-A22-Z06-H AFM88C-SN12Z-D080-A27-Z07-H
ZCC UCUNA UYGUNDUR. COMPATIBLE WITH ZCC INSERT.				ZCC UCUNA UYGUNDUR. COMPATIBLE WITH ZCC INSERT.			
67°	AFM67-PN1105	Uç / Insert	Takım Kodu / Tool Code				
		PNEG 1105..	AFM67-PN1105-D050-A22-Z05 AFM67-PN1105-D063-A22-Z06 AFM67-PN1105-D080-A27-Z08 AFM67-PN1105-D100-B32-Z10 AFM67-PN1105-D125-B40-Z12 AFM67-PN1105-D160-C40-Z14				
ZCC UCUNA UYGUNDUR. COMPATIBLE WITH ZCC INSERT.							

KONUŞULAN KALİTE
THE SPOKEN QUALITY



POLİGONAL ŞAFTLI YEKPARE TAKIMLAR

YENİ ÜRÜN / NEW PRODUCT

Hassas işleme ve üretimde mükemmeliyetçilik için tasarlandı.
Engineered for precision and excellence in manufacturing.

MONOBLOCK TOOLS WITH POLYGONAL SHANK



konusulan
the spoken *kalite...*
quality...



www.akko.com.tr

 **AKKO**[®]

TAKIM ●
TOOLHOLDER
WERKZEUGE



KONUŞULAN
KALİTE



TUTUCU
HOLDER ●
ROTATIONSWERKZEUGE

**AVRUPA'NIN EN BÜYÜK
TAKIM VE TUTUCU ENTEGRE ÜRETİM TESİSİ**

**EUROPE'S LARGEST
INTEGRATED TOOL AND HOLDER FACILITY**

**EUROPAS GRÖSSTE WERKZEUG UND
HALTERPRODUKTIONSSTÄTTE**

www.akko.com.tr

**THE SPOKEN
QUALITY**



**KESİCİ UÇ
● INSERT
WENDEPLATTEN**

DEĞİŞTİRİLEBİLİR UÇLU TAKIMLAR, TAKIM TUTUCU SİSTEMLER VE KESİCİ UÇLAR
INDEXABLE TOOLS, TOOL HOLDER SYSTEMS AND CUTTING INSERTS

KONUŞULAN
KALİTE

THE SPOKEN
QUALITY



MAKİNA SANAYİ VE TİCARET A.Ş.

Konya 5. Organize Sanayi Bölgesi
Aşağıpınarbaşı Osb Mh. 526 Nolu Sk. No:1
Selçuklu / KONYA / TÜRKİYE

Tel : +90 332 239 17 57 (pbx)
Fax : +90 332 239 17 52
GPS : 38.005409, 32.635734

www.akko.com.tr
akko@akko.com.tr
export@akko.com.tr



AKKO Metalworking Tools

Yenilikler için bizi takip edin!
Follow us for news!
Für Neuheiten bitte uns folgen!



EUROPE GmbH

Balgheimer Str. 40 78549 Spaichingen
GERMANY

Phone : +49 7424 905 4013
GPS : 48.06906079976586, 8.754463836369949

www.akkoeurope.eu / office@dakkoeurope.eu / info@dakkoeurope.eu



AKKO Metalworking Tools

Für Neuheiten bitte uns folgen!



USA INC.

Office: 900 N Arlington Heights Rd Itasca, IL 60143
Warehouse: 1055 W Devon Avenue Suite 300
Itasca IL 60143 Illinois, USA

Phone: +1 847 600 9606
GPS : 41.982969625099386, -88.00574353196833



AKKO USA INC.

Follow us for news!
www.akkousa.us
info@dakkousa.us



埃克工具(中国)有限公司

No.998, Baicao Road, Gaoxinxi District,
Chengdu China

Phone: +86 18328589975